



Design Example Report

Title	<i>10.5 W Multi Output Isolated Power Supply using TNY267P</i>
Specification	Input: 160V – 275VAC Output: 9V/400mA, 5V/800mA, 3.3V800mA
Application	Set Top Box
Author	Power Integrations Applications Department
Document Number	DER-55
Date	April 20, 2005
Revision	1.0

Summary and Features

This document is an engineering prototype report describing a Set Top Box power supply utilizing a *TinySwitch-II* TNY267.

- Low Component Count
- No X-Cap
- No Common Mode Choke
- Good Cross Regulation
- Very Low No Load Losses

The products and applications illustrated herein (including circuits external to the products and transformer construction) may be covered by one or more U.S. and foreign patents or potentially by pending U.S. and foreign patent applications assigned to Power Integrations. A complete list of Power Integrations' patents may be found at www.powerint.com.

Table Of Contents

1	Introduction.....	3
2	Power Supply Specification.....	4
3	Schematic.....	5
4	Circuit Description	6
4.1	Input EMI Filtering	6
4.2	Primary Clamp Snubber	6
4.3	Output filtering.....	6
4.4	Output Feedback.....	6
5	PCB Layout	7
6	Bill Of Materials	8
7	Transformer Specification.....	9
7.1	Electrical Diagram	9
7.2	Electrical Specifications.....	9
7.3	Materials.....	9
7.4	Transformer Build Diagram	10
7.5	Transformer Construction.....	10
	Transformer Spreadsheets.....	11
	Performance Data	13
7.6	Efficiency.....	13
7.7	Regulation	14
7.7.1	Load.....	14
7.7.2	Line	14
7.7.3	Cross Regulation.....	15
8	Thermal Performance.....	16
9	Waveforms	17
9.1	Drain Voltage and Current, Normal Operation	17
9.2	Output Voltage Start-up Profile	17
9.3	Drain Voltage and Current Start-up Profile.....	18
9.4	Load Transient Response (75% to 100% Load Step)	19
9.5	Output Ripple Measurements.....	20
9.5.1	Ripple Measurement Technique	20
9.5.2	Measurement Results	21
10	Conducted EMI	23
11	Revision History.....	25

Important Note:

Although this board is designed to satisfy safety isolation requirements, the engineering prototype has not been agency approved. Therefore, all testing should be performed using an isolation transformer to provide the AC input to the prototype board.

Design Reports contain a power supply design specification, schematic, bill of materials, and transformer documentation. Performance data and typical operation characteristics are included. Typically only a single prototype has been built.



1 Introduction

This document is an engineering prototype report describing a Set Top Box power supply utilizing a *TinySwitch-II* TNY267. This power supply is intended as a general purpose evaluation platform for *TinySwitch-II*.

The document contains the power supply specification, schematic, bill of materials, transformer documentation, printed circuit layout, and performance data.



Figure 1 – Populated Circuit Board Photograph.



2 Power Supply Specification

Description	Symbol	Min	Typ	Max	Units	Comment
Input						
Voltage	V_{IN}	160		275	VAC	2 Wire – no P.E.
Frequency	f_{LINE}	47	50/60	64	Hz	
No-load Input Power (230 VAC)				0.3	W	
Output						
Output Voltage 1	V_{OUT1}		9		V	± 6% 20 MHz Bandwidth
Output Ripple Voltage 1	$V_{RIPPLE1}$		50		mV	
Output Current 1	I_{OUT1}	100		400	mA	
Output Voltage 2	V_{OUT2}		5		V	± 5% 20 MHz Bandwidth
Output Ripple Voltage 2	$V_{RIPPLE2}$		50		mV	
Output Current 2	I_{OUT2}	20		800	mA	
Output Voltage 3	V_{OUT3}		3.3		V	± 5% 20 MHz Bandwidth
Output Ripple Voltage 3	$V_{RIPPLE3}$		50		mV	
Output Current 3	I_{OUT3}	300		800	mA	
Total Output Power						
Continuous Output Power	P_{OUT}			10.5	W	
Peak Output Power	P_{OUT_PEAK}			10.5	W	
Efficiency	η				%	Measured at P_{OUT} (10.5 W), 25 °C
Environmental						
Conducted EMI			Meets CISPR22B / EN55022B			
Safety			Designed to meet IEC950, UL1950 Class II			
Surge		6			kV	1.2/50 μ s surge, IEC 1000-4-5, Series Impedance: Differential Mode: 2 Ω Common Mode: 12 Ω
Surge		6			kV	100 kHz ring wave, 500 A short circuit current, differential and common mode
Ambient Temperature	T_{AMB}	0		50	°C	Free convection, sea level



3 Schematic

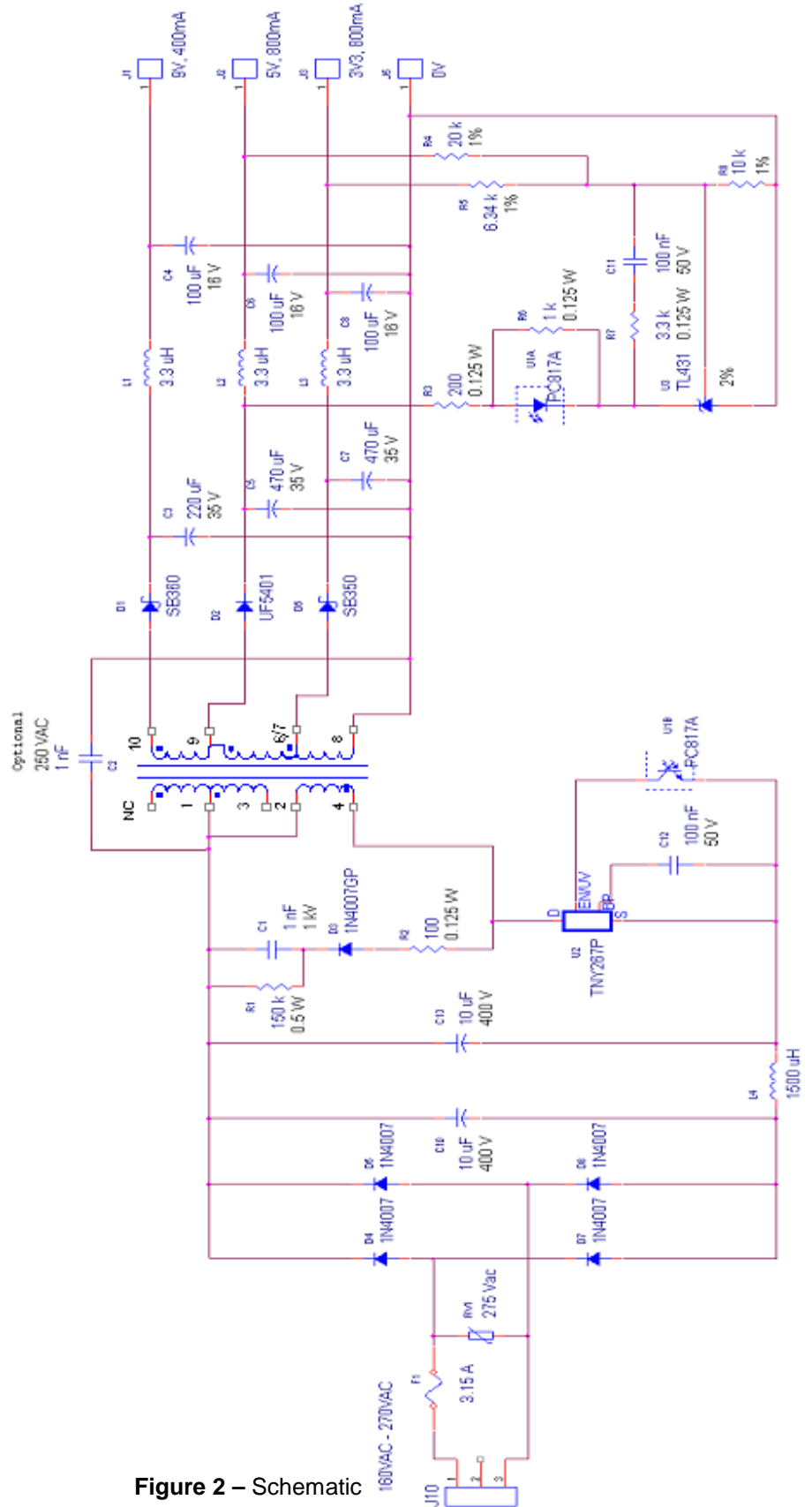

Figure 2 – Schematic



4 Circuit Description

4.1 Input EMI Filtering

C10, and C13 are the bulk capacitors. Together with L4, they form the EMI filter. TinySwitch-II's built-in frequency jitter helps achieve low EMI in spite of this very simple EMI filter.

4.2 Primary Clamp Snubber

D3, R1, R2, and C1 form the primary clamp snubber to clamp the voltage spike at the Drain pin after turn-off. D3 is a 1N4007G, a glass-passivated version of the standard 1N4007, with controlled reverse recovery. Its use, along with R2, improves EMI and efficiency. If a controlled recovery diode is not available, a fast diode must be used instead.

4.3 Output filtering

C3, C5, and C7 are the main output capacitors. C4, C6, and C8, along with L1, L2, and L3, form second-stage output filters.

4.4 Output Feedback

Sensing resistors R4 and R5 detect any variation in the amplitude of the 3.3V and 5V outputs. These changes, due to changes in the output load or input voltage, are sampled to the input pin of the TL431 shunt regulator. The shunt regulator compares these variations with its internal voltage reference and drives a feedback current through U1B proportional to the variations detected by R4 and R5. Opto-coupler U1 closes the control loop of the supply by transferring the feedback current to the output of the EN/UV pin on the primary side of the circuit.



5 PCB Layout

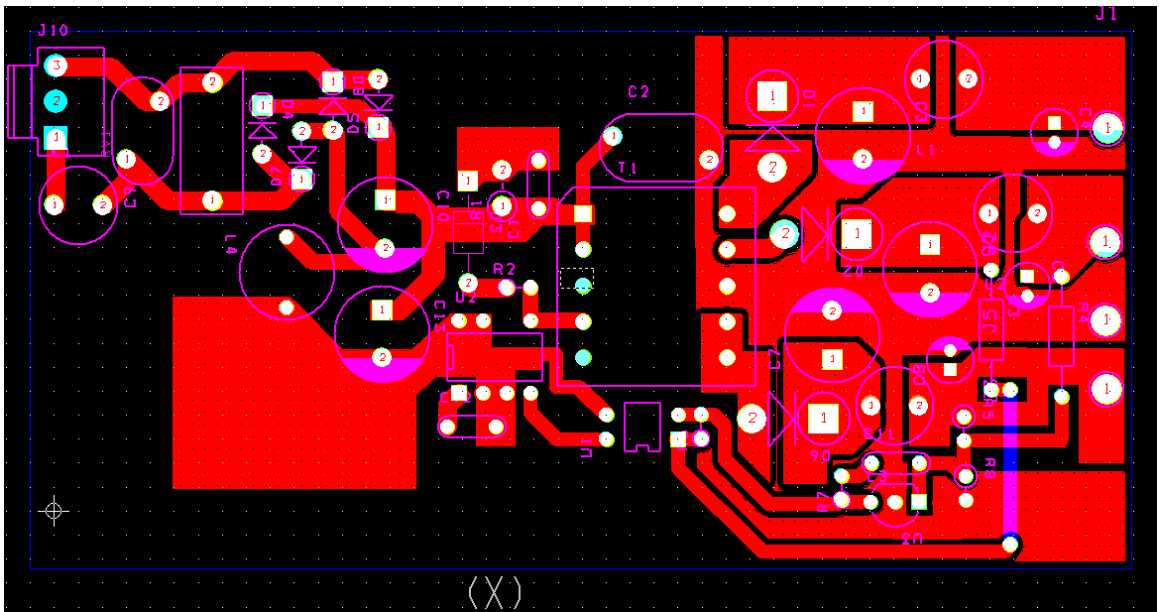

Figure 3 – Printed Circuit Layout



6 Bill Of Materials

Item	Qty	Value	Part Reference	Description	Mfg
1	1	1 nF	C1	1 nF, 1 kV, Disc Ceramic	NIC Components Corp
2	1	1 nF	C2	1 nF, Ceramic, Y1	Vishay
3	1	220 uF	C3	220 uF, 35 V, Electrolytic, Low ESR, 90 mOhm, (10 x 12.5)	United Chemi-Con
4	3	100 uF	C4 C6 C8	100 uF, 16 V, Electrolytic, Gen. Purpose, (5 x 11)	United Chemi-Con
5	2	470 uF	C5 C7	470 uF, 35 V, Electrolytic, Low ESR, 52 mOhm, (10 x 20)	United Chemi-Con
6	2	10 uF	C10 C13	10uF, 400V, Electrolytic	Panasonic
7	2	100 nF	C11 C12	100 nF, 50 V, Ceramic, X7R	Panasonic
8	1	SB360	D1	60 V, 3 A, Schottky, DO-201AD	Vishay
9	1	UF5401	D2	100 V, 3 A, Ultrafast Recovery, 50 ns, DO-201AD	Vishay
10	1	1N4007GP	D3	1000 V, 1 A, Rectifier, Glass Passivated, 2 us, DO-41	Vishay
11	4	1N4007	D4 D5 D7 D8	1000 V, 1 A, Rectifier, DO-41	Vishay
12	1	SB350	D6	50 V, 3 A, Schottky, DO-201AD	Vishay
13	1	3.15 A	F1	3.15 A, 250V, Fast, TR5	Wickman
14	3	3.3 uH	L1 L2 L3	3.3 uH, 2.66 A	Toko
15	1	1500 uH	L4	1500 uH, 0.45 A	Tokin
16	1	150 k	R1	150 k, 5%, 1/2 W, Carbon Film	Yageo
17	1	100R	R2	100 R, 5%, 1/8 W, Carbon Film	Yageo
18	1	200R	R3	200 R, 5%, 1/8 W, Carbon Film	Yageo
19	1	20 k	R4	20 k, 1%, 1/4 W, Metal Film	Yageo
20	1	6.34 k	R5	6.34 k, 1%, 1/4 W, Metal Film	Yageo
21	1	1 k	R6	1 k, 5%, 1/8 W, Carbon Film	Yageo
22	1	3.3 k	R7	3.3 k, 5%, 1/8 W, Carbon Film	Yageo
23	1	10 k	R8	10 k, 1%, 1/4 W, Metal Film	Yageo
24	1	275 Vac	RV1	275 V, 23 J, 7 mm, RADIAL	Littlefuse
25	1	EF20	T1	Bobbin, EF20,(E20/10/6) Horizontal, 10 pins	Epcos
26	1	PC817A	U1	Opto coupler, 35 V, CTR 80-160%, 4-DIP	Isocom, Sharp
27	1	TNY267P	U2	TinySwitch-II, TNY267P, DIP-8B	Power Integrations
28	1	TL431	U3	2.495 V Shunt Regulator IC, 2%, 0 to 70C, TO-92	Texas Instruments



7 Transformer Specification

7.1 Electrical Diagram

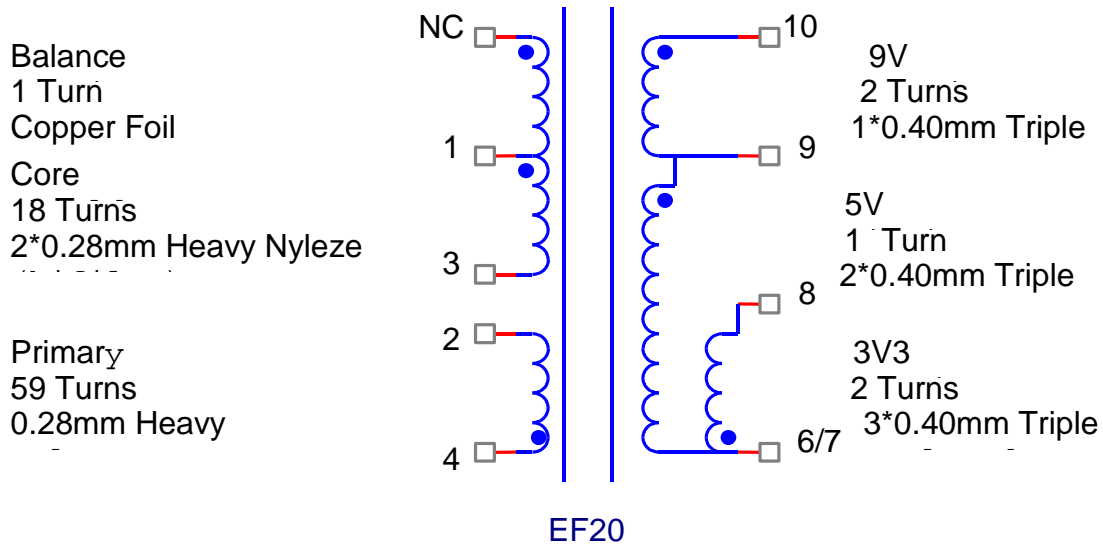

Figure 4 –Transformer Electrical Diagram

7.2 Electrical Specifications

Electrical Strength	1 second, 60 Hz, from Pins 2-4 to Pins 6-10	3000 VAC
Primary Inductance	Pins 2-4, all other windings open, measured at 100 kHz, 0.4 VRMS	1340 μ H, -0/+20%
Resonant Frequency	Pins 2-4, all other windings open	950 kHz (Min.)
Primary Leakage Inductance	Pins 2-4, with Pins 6-10 shorted, measured at 100 kHz, 0.4 VRMS	50 μ H (Max.)

7.3 Materials

Item	Description
[1]	Core: PC40EF20-Z, TDK or equivalent Gapped for AL of 327 nH/T ²
[2]	Bobbin: EF20 Horizontal 10 pin
[3]	Magnet Wire: 0.28mm
[4]	Triple Isolated Wire: 0.4mm
[5]	Copper Foil: 0.1mm*12mm
[6]	Tape: 3M 1298 Polyester Film, 2.0 mils thick, 12 mm wide
[7]	Varnish

7.4 Transformer Build Diagram

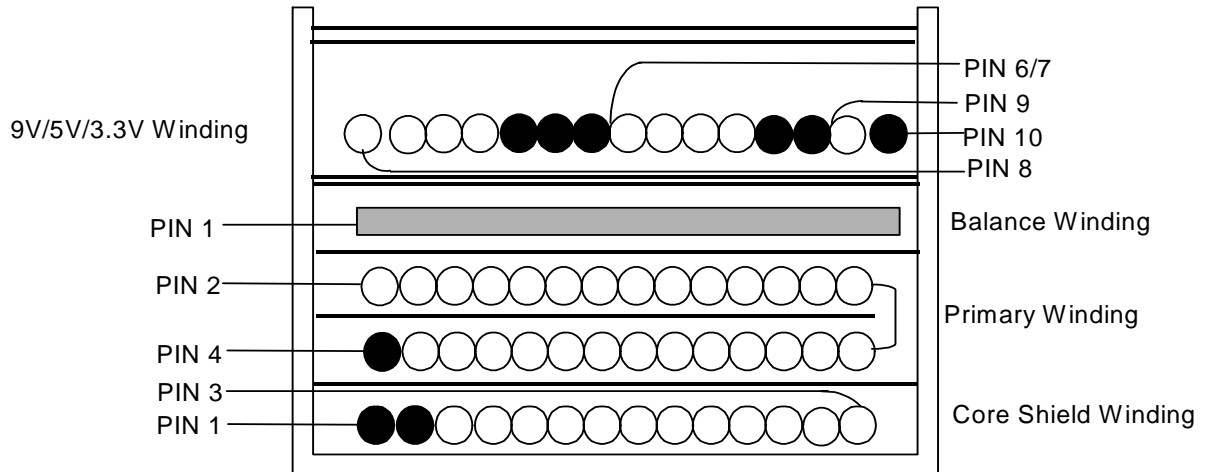

Figure 5 – Transformer Build Diagram

7.5 Transformer Construction

Core Shield	Start at Pin1. Wind 14 bifilar turns of item [3] from left to right covering a single full layer. Finish at Pin3.
Tape	1 layer of item [6] for mechanical fixing.
Primary	Start at Pin 4. Wind 59 turns of item [4] in 2 layers (about 32T in the first Layer and 27T in the second Layer) from left to right (Isolated with one layer tape item [6]). Finish on Pin2.
Basic Insulation	1 layer of item [6] for basic insulation.
Balance Winding	Start on pin 1 using item [5] at the start leads. Wind 1 turns of copper shield. Apply next step tape item [6] first before close this winding to avoid copper shortage.
Insulation	Use 2 layers of item [6] for basic insulation
9V, 5V and 3V3 Winding	Start at Pin 10. Wind 2 turns of item [4] from right to left. Terminate on Pin 9. In the same layer start at Pin 9. Wind 1 bifilar turn of item [4] and terminate on Pin 6. Again in the same layer start at Pin 7. Wind 2 trifilar turns of item [4] and terminate on Pin 8.
Outer Wrap	Wrap windings with 2 layers of tape item [6].
Final Assembly	Assemble and secure core halves so that the tape wrapped EF core is at the bottom of the transformer. Varnish impregnate (item [7]).

Transformer Spreadsheets

	INPUT	INFO	OUTPUT	UNIT	
ENTER APPLICATION VARIABLES					
VACMIN	160			Volts	Minimum AC Input Voltage
VACMAX	270			Volts	Maximum AC Input Voltage
fL	50			Hertz	AC Mains Frequency
VO	5			Volts	Output Voltage
PO	10.24			Watts	Output Power
n	0.75				Efficiency Estimate
Z			0.50		Loss Allocation Factor
tC			3.00	mSeconds	Bridge Rectifier Conduction Time Estimate
CIN	10			uFarads	Input Filter Capacitor
ENTER TinySwitch-II VARIABLES					
TinySwitch-II	tny267			Universal	115 Doubled/230V
Chosen Device		TNY267	Power Out	12W	19W
ILIMITMIN				0.42 Amps	TinySwitch-II Minimum Current Limit
ILIMITMAX				0.48 Amps	TinySwitch-II Maximum Current Limit
fS				132000.00 Hertz	TinySwitch-II Switching Frequency
fSmin				120000.00 Hertz	TinySwitch-II Minimum Switching Frequency (inc. jitter)
fSmax				144000.00 Hertz	TinySwitch-II Maximum Switching Frequency (inc. jitter)
VOR	110			Volts	Reflected Output Voltage
VDS				10.00 Volts	TinySwitch-II on-state Drain to Source Voltage
VD	0.6			Volts	Output Winding Diode Forward Voltage Drop
KP				1.14	Ripple to Peak Current Ratio (0.6<KRP<1.0 : 1.0<KDP<6.0)
ENTER TRANSFORMER CORE/CONSTRUCTION VARIABLES					
Core Type	EF20			P/N:	PC40EF20-Z
Core		EF20		P/N:	*
Bobbin		EF20_BOBBIN			
AE				0.34 cm^2	Core Effective Cross Sectional Area
LE				4.49 cm	Core Effective Path Length
AL				1570.00 nH/T^2	Ungapped Core Effective Inductance
BW				12.20 mm	Bobbin Physical Winding Width
M	0			mm	Safety Margin Width (Half the Primary to Secondary Creepage Distance)
L	2				Number of Primary Layers
NS	3				Number of Secondary Turns
DC INPUT VOLTAGE PARAMETERS					
VMIN				179.12 Volts	Minimum DC Input Voltage
VMAX				381.84 Volts	Maximum DC Input Voltage
CURRENT WAVEFORM SHAPE PARAMETERS					
DMAX				0.39	Maximum Duty Cycle
I AVG				0.08 Amps	Average Primary Current
IP				0.42 Amps	Minimum Peak Primary Current
IR				0.45 Amps	Primary Ripple Current
IRMS				0.15 Amps	Primary RMS Current
TRANSFORMER PRIMARY DESIGN PARAMETERS					
LP				1134.14 uHenries	Primary Inductance
NP				58.93	Primary Winding Number of Turns
ALG				326.60 nH/T^2	Gapped Core Effective Inductance
BM				2763.39 Gauss	Maximum Flux Density, (BP<3100)
BAC				1381.69 Gauss	AC Flux Density for Core Loss Curves (0.5 X Peak to Peak)
ur				1674.52	Relative Permeability of Ungapped Core
LG				0.10 mm	Gap Length (Lg > 0.1 mm)
BWE				24.40 mm	Effective Bobbin Width
OD				0.41 mm	Maximum Primary Wire Diameter including insulation
INS				0.06 mm	Estimated Total Insulation Thickness (= 2 * film thickness)
DIA				0.35 mm	Bare conductor diameter
AWG				28.00 AWG	Primary Wire Gauge (Rounded to next smaller standard AWG value)
CM				161.27 Cmls	Bare conductor effective area in circular mils
CMA		Info		1105.22 Cmls/Amp	CAN DECREASE CMA < 500 (decrease L(primary layers),increase NS,smaller Core)
TRANSFORMER SECONDARY DESIGN PARAMETERS					
Lumped parameters					



ISP	8.23 Amps	Peak Secondary Current
ISRMS	3.55 Amps	Secondary RMS Current
IO	2.05 Amps	Power Supply Output Current
IRIPPLE	2.90 Amps	Output Capacitor RMS Ripple Current
CMS	710.80 Cmils	Secondary Bare Conductor minimum circular mils
		Secondary Wire Gauge (Rounded up to next larger standard AWG value)
AWGS	21.00 AWG	
DIAS	0.73 mm	Secondary Minimum Bare Conductor Diameter
ODS	4.07 mm	Secondary Maximum Outside Diameter for Triple Insulated Wire
INSS	1.67 mm	Maximum Secondary Insulation Wall Thickness

VOLTAGE STRESS PARAMETERS

VDRAIN	632.84 Volts	Maximum Drain Voltage Estimate (Includes Effect of Leakage Inductance)
PIVS	24.44 Volts	Output Rectifier Maximum Peak Inverse Voltage

TRANSFORMER SECONDARY DESIGN PARAMETERS (MULTIPLE OUTPUTS)**1st output**

VO1	5	5.00 Volts	Output Voltage (if unused, defaults to single output design)
IO1	0.8	0.80 Amps	Output DC Current
PO1		4.00 Watts	Output Power
VD1		0.60 Volts	Output Diode Forward Voltage Drop
NS1		3.00	Output Winding Number of Turns
ISRMS1		1.39 Amps	Output Winding RMS Current
IRIPPLE1		1.13 Amps	Output Capacitor RMS Ripple Current
PIVS1		24.44 Volts	Output Rectifier Maximum Peak Inverse Voltage
CMS1		277.65 Cmils	Output Winding Bare Conductor minimum circular mils
AWGS1		25.00 AWG	Wire Gauge (Rounded up to next larger standard AWG value)
DIAS1		0.46 mm	Minimum Bare Conductor Diameter
ODS1		4.07 mm	Maximum Outside Diameter for Triple Insulated Wire

2nd output

VO2	3.3	Volts	Output Voltage
IO2	0.8	Amps	Output DC Current
PO2		2.64 Watts	Output Power
VD2	0.6	Volts	Output Diode Forward Voltage Drop
NS2		2.09	Output Winding Number of Turns
ISRMS2		1.39 Amps	Output Winding RMS Current
IRIPPLE2		1.13 Amps	Output Capacitor RMS Ripple Current
PIVS2		16.84 Volts	Output Rectifier Maximum Peak Inverse Voltage
CMS2		277.65 Cmils	Output Winding Bare Conductor minimum circular mils
AWGS2		25.00 AWG	Wire Gauge (Rounded up to next larger standard AWG value)
DIAS2		0.46 mm	Minimum Bare Conductor Diameter
ODS2		5.84 mm	Maximum Outside Diameter for Triple Insulated Wire

3rd output

VO3	9	Volts	Output Voltage
IO3	0.4	Amps	Output DC Current
PO3		3.60 Watts	Output Power
VD3	0.5	Volts	Output Diode Forward Voltage Drop
NS3		5.09	Output Winding Number of Turns
ISRMS3		0.69 Amps	Output Winding RMS Current
IRIPPLE3		0.57 Amps	Output Capacitor RMS Ripple Current
PIVS3		41.98 Volts	Output Rectifier Maximum Peak Inverse Voltage
CMS3		138.83 Cmils	Output Winding Bare Conductor minimum circular mils
AWGS3		28.00 AWG	Wire Gauge (Rounded up to next larger standard AWG value)
DIAS3		0.32 mm	Minimum Bare Conductor Diameter
ODS3		2.40 mm	Maximum Outside Diameter for Triple Insulated Wire

Total power	10.24 Watts	Total Output Power
--------------------	-------------	--------------------



Performance Data

7.6 Efficiency

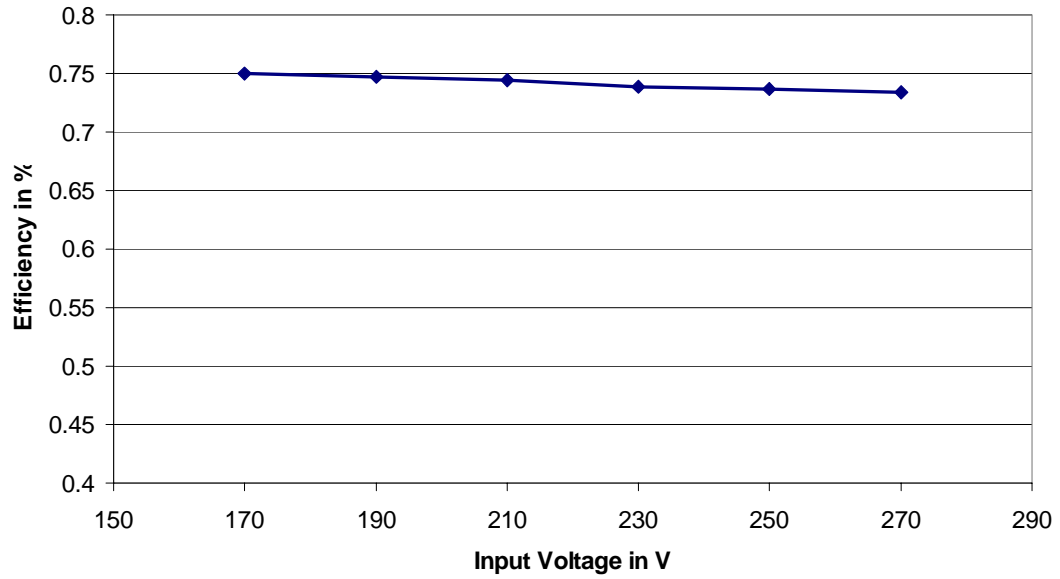

Figure 6 - Efficiency vs. Input Voltage, Room Temperature, 50 Hz



7.7 Regulation

7.7.1 Load

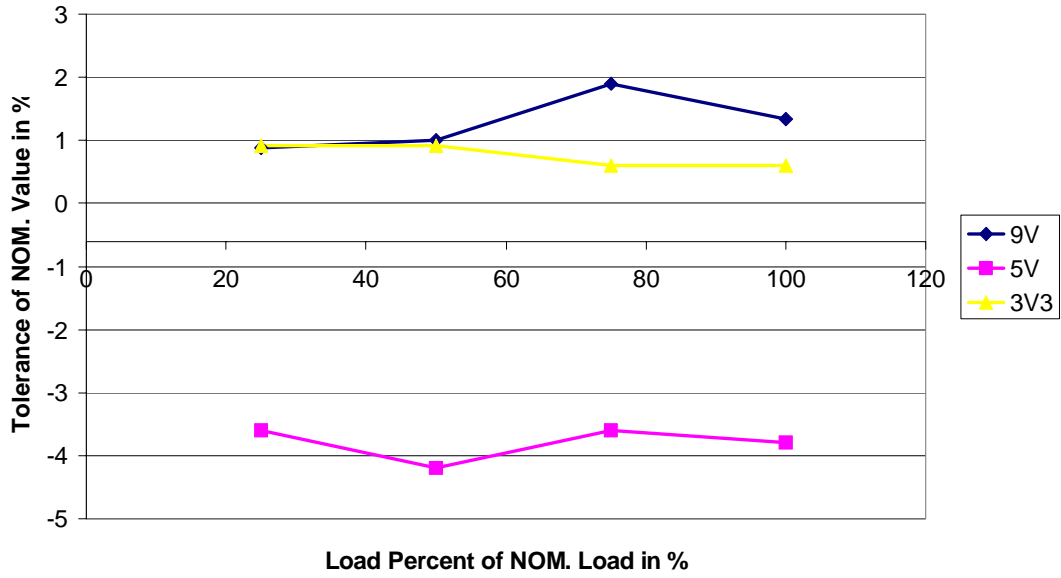

Figure 7 – Load Regulation, Room Temperature

7.7.2 Line

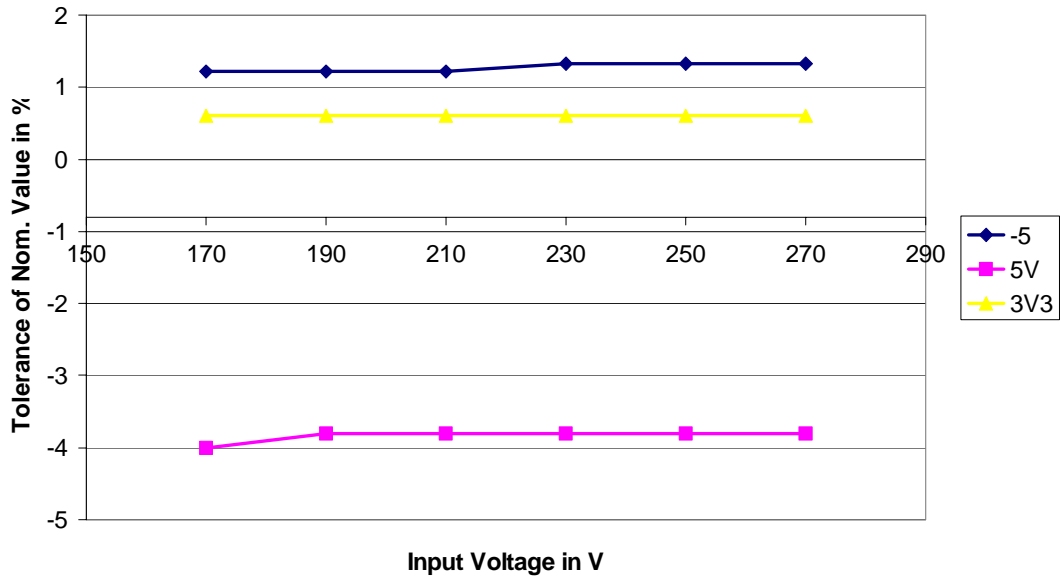

Figure 8 – Line Regulation, Room Temperature, Full Load



7.7.3 Cross Regulation

	9V Rail (A)	5V Rail (A)	3V3 Rail (A)
Min Load (X)	0.1	0.02	0.3
Max Load (M)	0.4	0.8	0.8
Load Combinations	Voltage (V)	Voltage (V)	Voltage (V)
9V 5V 3V3			
XXX	9.1	4.95	3.29
XXM	9.52	5.17	3.21
XXM	9.29	4.73	3.36
MXX	8.78	4.93	3.29
XMM	9.67	4.81	3.32
MXM	9	5.06	3.24
MMX	8.95	4.74	3.35
MMM	9.12	4.81	3.31
Min (V)	8.78	4.73	3.21
Max (V)	9.67	5.17	3.36
% Below	-2.44	-5.40	-2.73
% Above	7.44	3.40	1.82



8 Thermal Performance

Temperature (°C)			
Item	160 VAC	230 VAC	275 VAC
Ambient	50	50	50
5V Output Diode	62	66	68
3.3V Output Diode	64.2	67	68
Transformer (T1)	65	68	69
<i>TinySwitch</i> (U2)	85	86	89



9 Waveforms

9.1 Drain Voltage and Current, Normal Operation

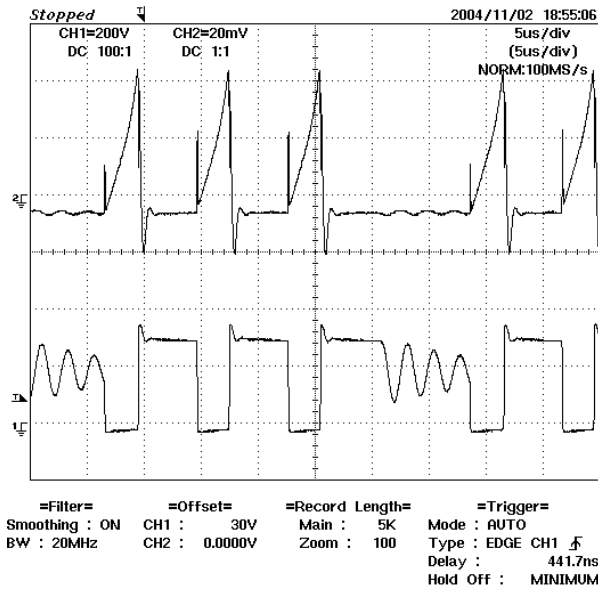

Figure 9 - 160VAC, Full Load.
 Upper: I_{DRAIN} , 0.25 A / div
 Lower: V_{DRAIN} , 200 V, 5 μ s / div

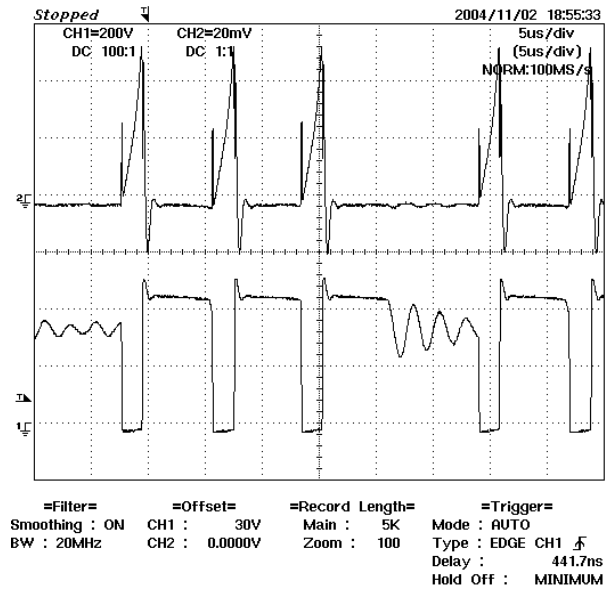

Figure 10 - 275 VAC, Full Load
 Upper: I_{DRAIN} , 0.25 A / div
 Lower: V_{DRAIN} , 200 V / div

9.2 Output Voltage Start-up Profile

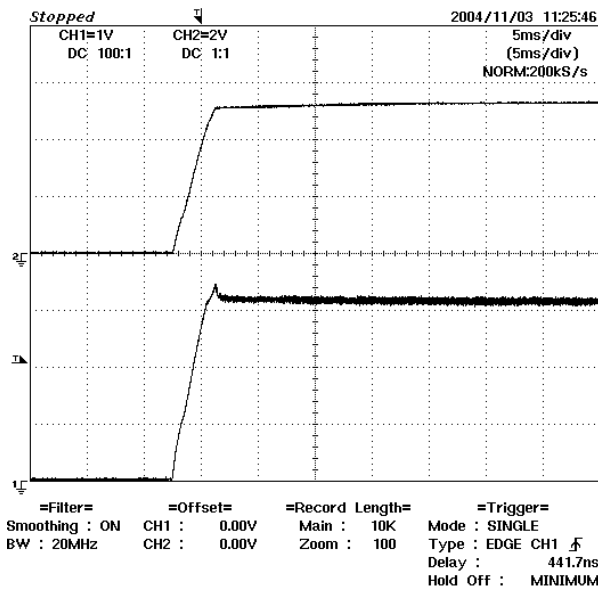

Figure 11 - Start-up Profile, 160 VAC
 5 ms / div.
 Upper: 5V Output, 2/ div
 Lower: 3V3 Output, 1/ div

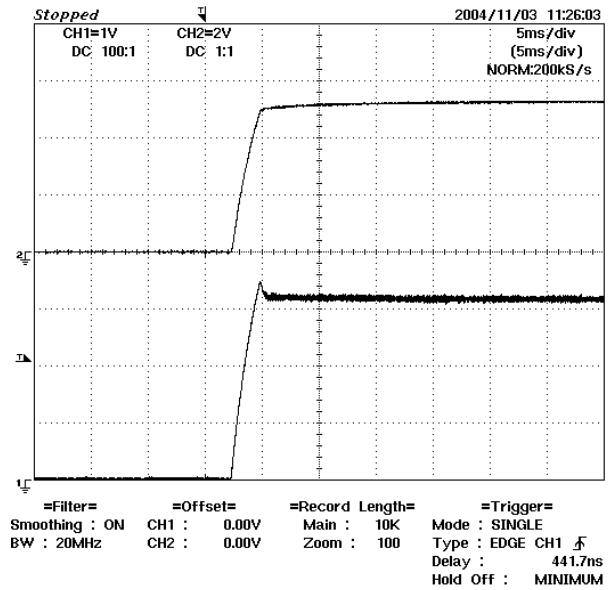

Figure 12 - Start-up Profile, 275 VAC
 5 ms / div.
 Upper: 5V Output, 2/ div
 Lower: 3V3 Output, 1/ div



9.3 Drain Voltage and Current Start-up Profile

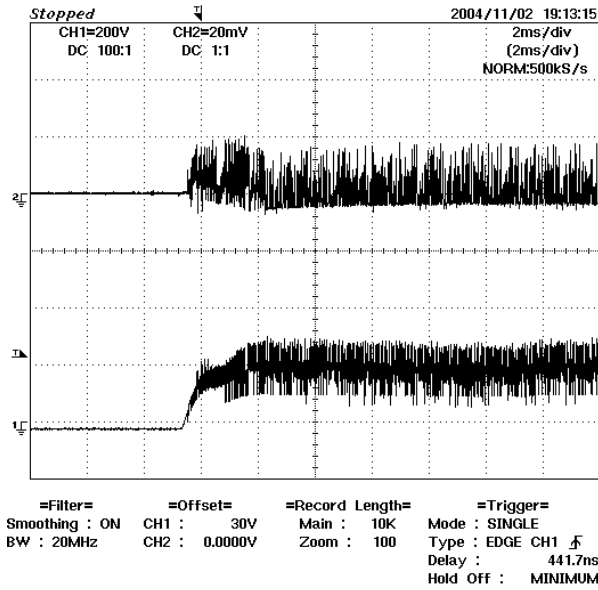

Figure 13 - 160 VAC Input and Maximum Load.
 Upper: I_{DRAIN} , 0.5 A / div.
 Lower: V_{DRAIN} , 200 V & 2 ms / div.

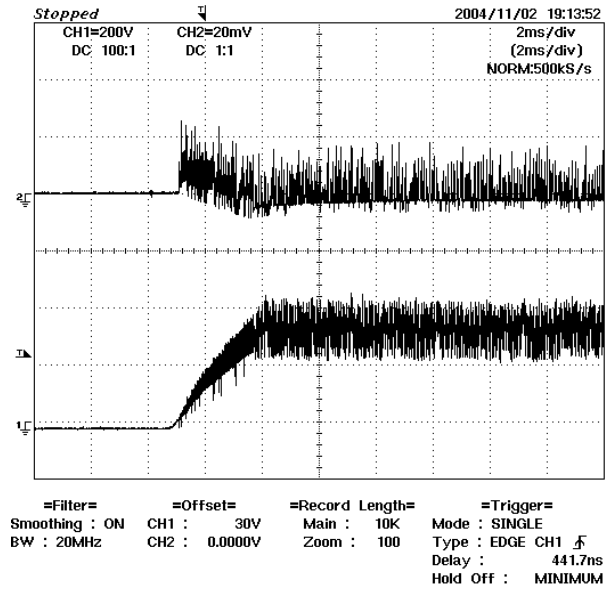

Figure 14 - 275 VAC Input and Maximum Load.
 Upper: I_{DRAIN} , 0.5 A / div.
 Lower: V_{DRAIN} , 200 V & 2 ms / div.

9.4 Load Transient Response (75% to 100% Load Step)

In the figures shown below, signal averaging was used to better enable viewing the load transient response. The oscilloscope was triggered using the load current step as a trigger source. Since the output switching and line frequency occur essentially at random with respect to the load transient, contributions to the output ripple from these sources will average out, leaving the contribution only from the load step response.

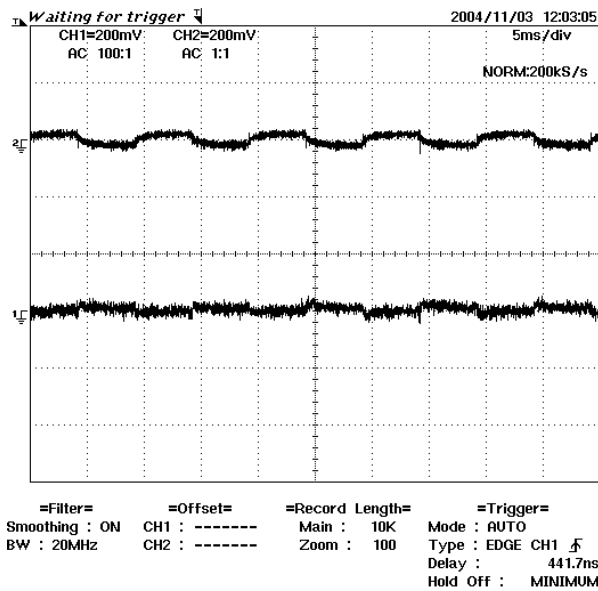

Figure 15 – Transient Response, 230 VAC, 75-100-75% Load Step (5V Output).
 Top: 5V Output
 Bottom: 3V3 Output
 50 mV, 500 μ s / div.

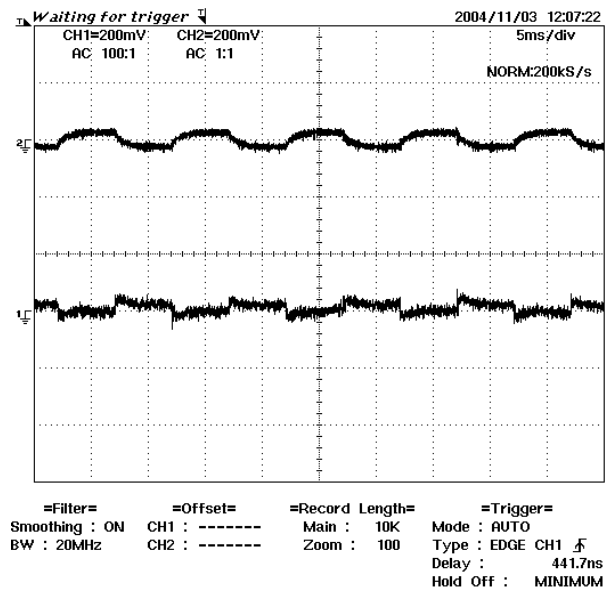

Figure 16 – Transient Response, 230 VAC, 75-100-75% Load Step (3V3 Output)
 Upper: 5V Output
 Bottom: 3V3 Output
 50 mV, 2 ms / div.

9.5 Output Ripple Measurements

9.5.1 Ripple Measurement Technique

For DC output ripple measurements, a modified oscilloscope test probe must be utilized in order to reduce spurious signals due to pickup. Details of the probe modification are provided in Figure 17 and Figure 18.

The 5125BA probe adapter is affixed with two capacitors tied in parallel across the probe tip. The capacitors include one (1) 0.1 $\mu\text{F}/50\text{ V}$ ceramic type and one (1) 1.0 $\mu\text{F}/50\text{ V}$ aluminum electrolytic. **The aluminum electrolytic type capacitor is polarized, so proper polarity across DC outputs must be maintained (see below).**

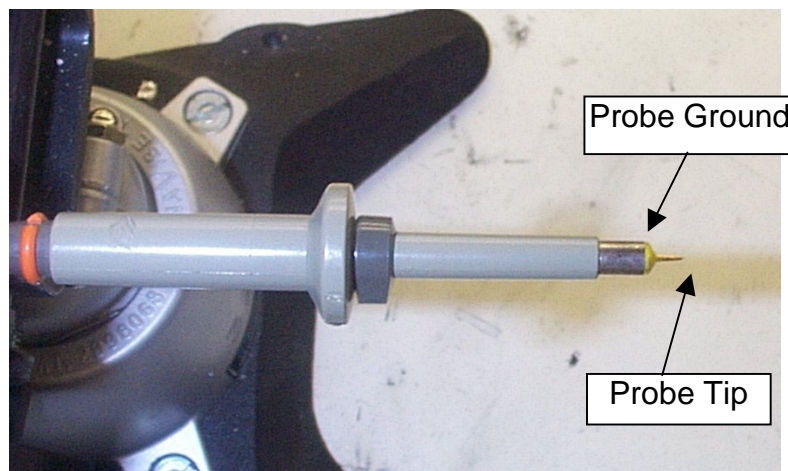

Figure 17 - Oscilloscope Probe Prepared for Ripple Measurement. (End Cap and Ground Lead Removed)

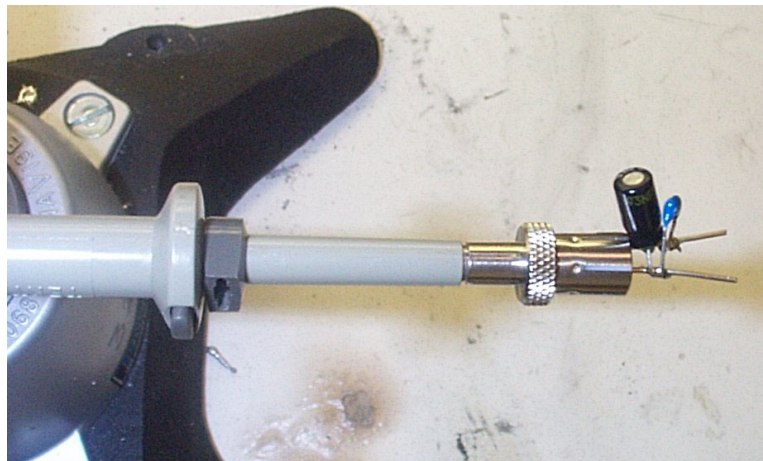

Figure 18 - Oscilloscope Probe with Probe Master 5125BA BNC Adapter. (Modified with wires for probe ground for ripple measurement, and two parallel decoupling capacitors added)

9.5.2 Measurement Results

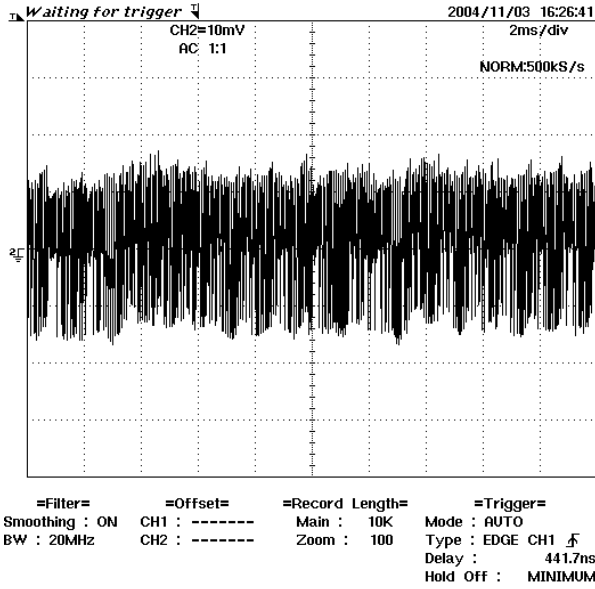

Figure 19 - Ripple, 160 VAC, Full Load.
9V Output 2 ms, 50 mV / div

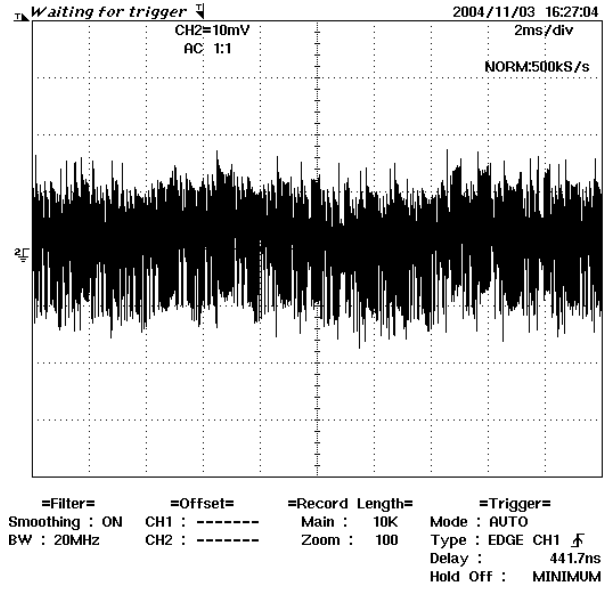

Figure 20 - 5 V Ripple, 275 VAC, Full Load.
9V Output 2 ms, 50 mV / div

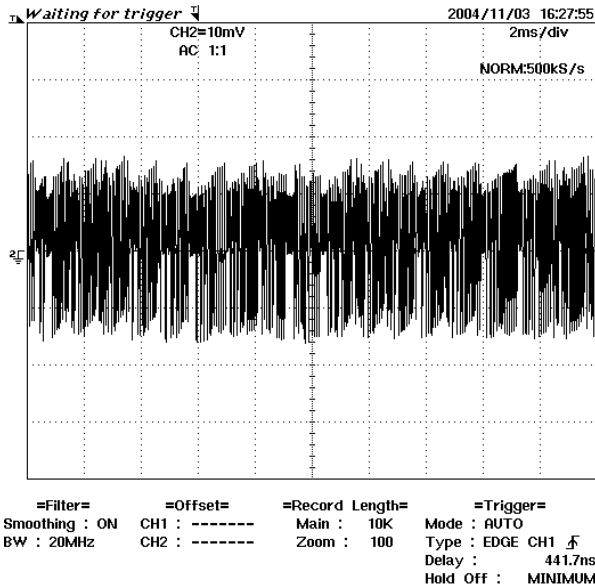

Figure 21 - Ripple, 160 VAC, Full Load.
5V Output 2 ms, 50 mV / div

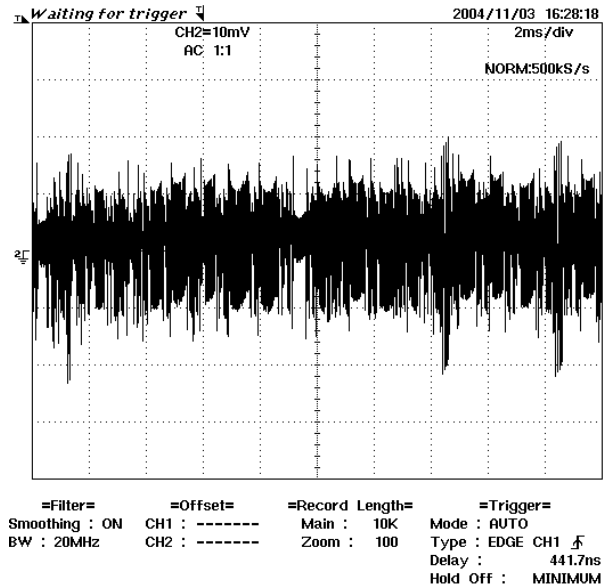

Figure 22 - 5 V Ripple, 275 VAC, Full Load.
5V Output 2 ms, 50 mV / div

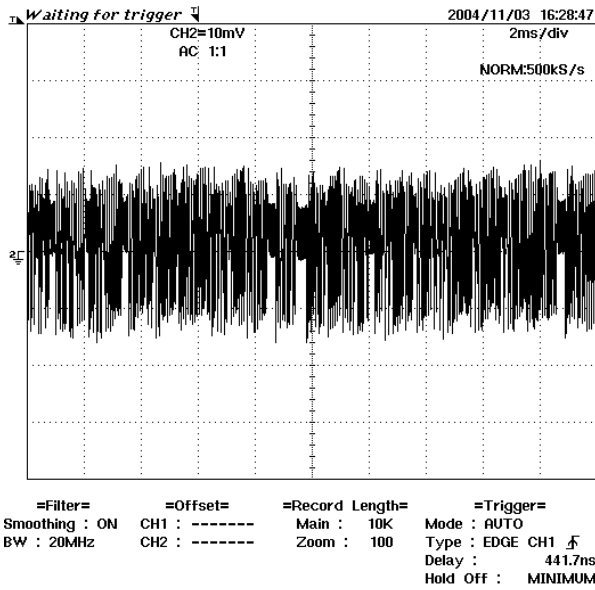

Figure 23 - Ripple, 160 VAC, Full Load.
 3V3 Output 2 ms, 50 mV /div

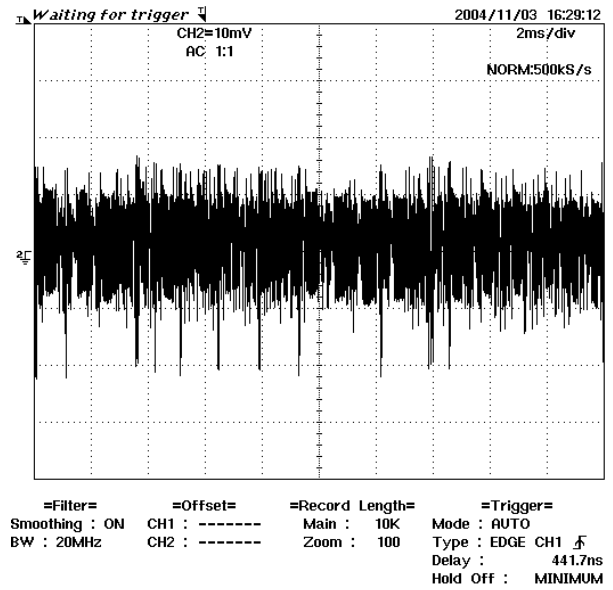

Figure 24 - 5 V Ripple, 275 VAC, Full Load.
 3V3 Output 2 ms, 50 mV / div

10 Conducted EMI

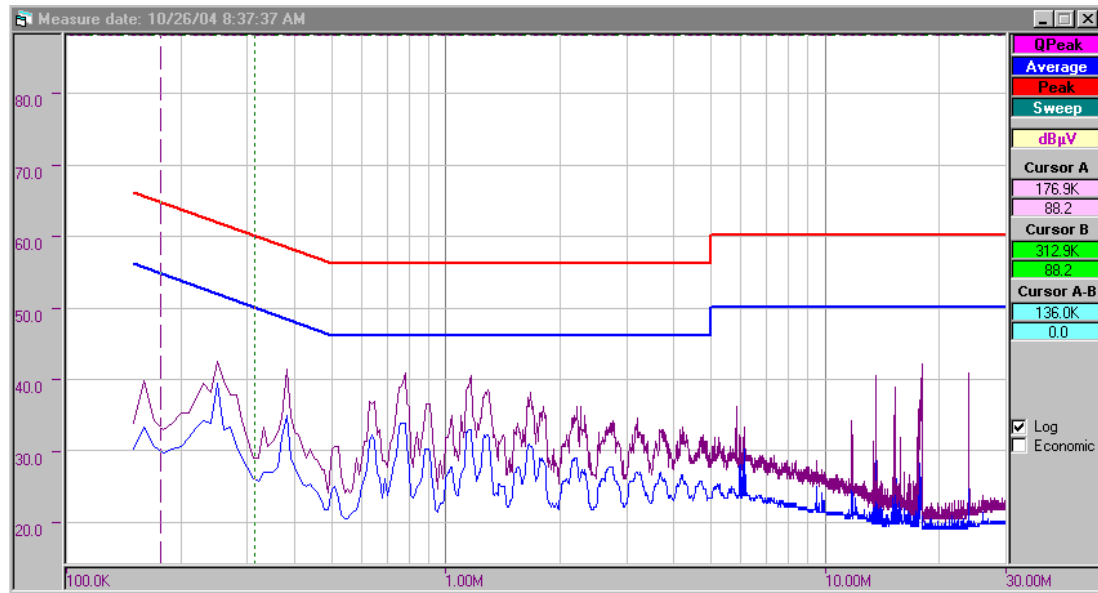

Figure 25 - Conducted EMI, Maximum Steady State Load, 230 VAC, 50 Hz, and EN5022 B Limits Secondary Ground Floating

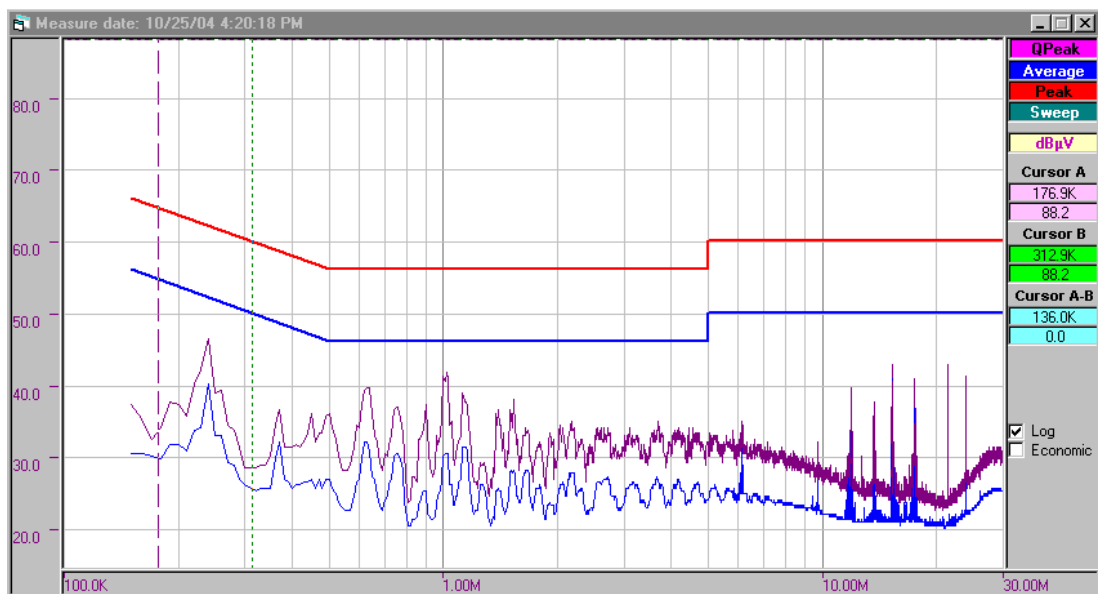

Figure 26 - Conducted EMI, Maximum Steady State Load, 230 VAC, 50 Hz, and EN5022 B Limits Secondary Ground connected to Artificial Hand



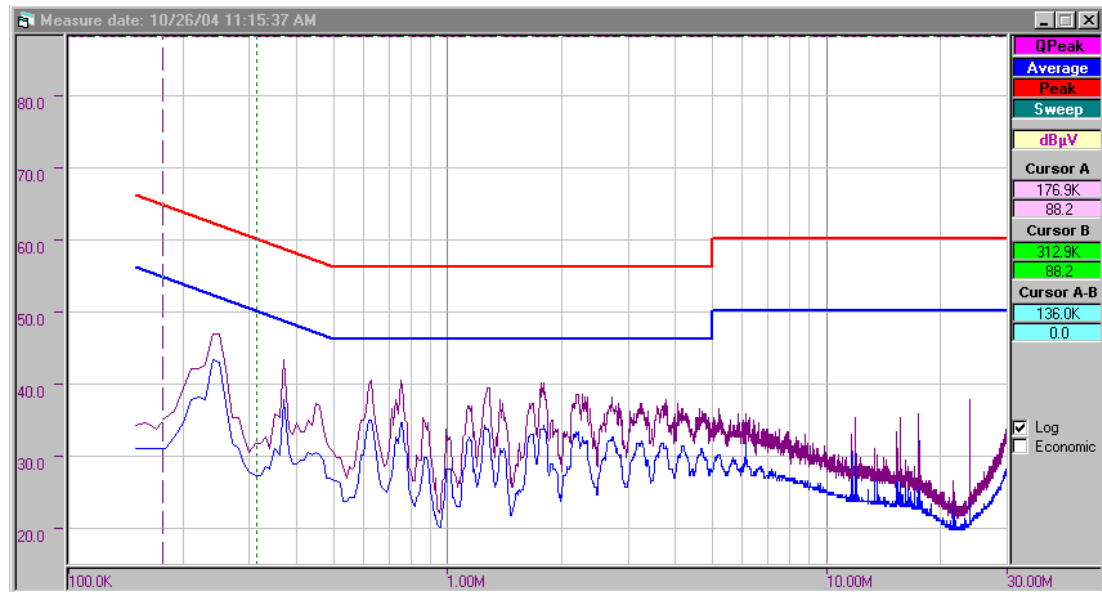

Figure 27 - Conducted EMI, Maximum Steady State Load, 230 VAC, 50 Hz, and EN55022 B Limits Secondary Ground Floating (Without Y-Cap)



11 Revision History

Date	Author	Revision	Description & changes	Reviewed
April 20, 2005	HM	1.0	Initial Release	VC / AM



For the latest updates, visit our Web site: www.powerint.com

Power Integrations may make changes to its products at any time. Power Integrations has no liability arising from your use of any information, device or circuit described herein nor does it convey any license under its patent rights or the rights of others. POWER INTEGRATIONS MAKES NO WARRANTIES HEREIN AND SPECIFICALLY DISCLAIMS ALL WARRANTIES INCLUDING, WITHOUT LIMITATION, THE IMPLIED WARRANTIES OF MERCHANTABILITY, FITNESS FOR A PARTICULAR PURPOSE, AND NON-INFRINGEMENT OF THIRD PARTY RIGHTS.

PATENT INFORMATION

The products and applications illustrated herein (including circuits external to the products and transformer construction) may be covered by one or more U.S. and foreign patents or potentially by pending U.S. and foreign patent applications assigned to Power Integrations. A complete list of Power Integrations' patents may be found at www.powerint.com.

The PI Logo, **TOPSwitch**, **TinySwitch**, **LinkSwitch**, and **EcoSmart** are registered trademarks of Power Integrations. **PI Expert** and **DPA-Switch** are trademarks of Power Integrations.
© Copyright 2004, Power Integrations.

WORLD HEADQUARTERS

Power Integrations
5245 Hellyer Avenue,
San Jose, CA 95138, USA
Main: +1-408-414-9200
Customer Service:
Phone: +1-408-414-9665
Fax: +1-408-414-9765
e-mail:
usasales@powerint.com

AMERICAS

Power Integrations, Inc.
4335 South Lee Street,
Suite G,
Buford, GA 30518, USA
Phone: +1-678-714-6033
Fax: +1-678-714-6012
e-mail:
usasales@powerint.com

CHINA (SHANGHAI)

Power Integrations
International Holdings, Inc.
Rm 807, Pacheer,
Commercial Centre,
555 Nanjing West Road,
Shanghai, 200041, China
Phone: +86-21-6215-5548
Fax: +86-21-6215-2468
e-mail:
chinasales@powerint.com

APPLICATIONS HOTLINE

World Wide +1-408-414-9660

CHINA (SHENZHEN)

Power Integrations
International Holdings, Inc.
Rm# 1705, Bao Hua Bldg.
1016 Hua Qiang Bei Lu,
Shenzhen, Guangdong,
518031, China
Phone: +86-755-8367-5143
Fax: +86-755-8377-9610
e-mail: chinasales@powerint.com

GERMANY

Power Integrations, GmbH
Rueckertstrasse 3,
D-80336, Munich, Germany
Phone: +49-895-527-3910
Fax: +49-895-527-3920
e-mail: eurossales@powerint.com

INDIA (TECHNICAL SUPPORT)

Innovatech
261/A, Ground Floor
7th Main, 17th Cross,
Sadashivanagar
Bangalore, India, 560080
Phone: +91-80-5113-8020
Fax: +91-80-5113-8023
e-mail: indiasales@powerint.com

APPLICATIONS FAX

World Wide +1-408-414-9760

ITALY

Power Integrations s.r.l.
Via Vittorio Veneto 12,
Bresso, Milano,
20091, Italy
Phone: +39-028-928-6001
Fax: +39-028-928-6009
e-mail:
eurossales@powerint.com

JAPAN

Power Integrations, K.K.
Keihin-Tatemono 1st Bldg.
12-20 Shin-Yokohama,
2-Chome,
Kohoku-ku, Yokohama-shi,
Kanagawa 222-0033, Japan
Phone: +81-45-471-1021
Fax: +81-45-471-3717
e-mail:
japansales@powerint.com

KOREA

Power Integrations
International Holdings, Inc.
8th Floor, DongSung Bldg.
17-8 Yoido-dong,
Youngdeungpo-gu,
Seoul, 150-874, Korea
Phone: +82-2-782-2840
Fax: +82-2-782-4427
e-mail:
koreasales@powerint.com

SINGAPORE (ASIA PACIFIC HEADQUARTERS)

Power Integrations, Singapore
51 Newton Road,
#15-08/10 Goldhill Plaza,
Singapore, 308900
Phone: +65-6358-2160
Fax: +65-6358-2015
e-mail:
singaporesales@powerint.com

TAIWAN

Power Integrations
International Holdings, Inc.
17F-3, No. 510,
Chung Hsiao E. Rd., Sec. 5,
Taipei, Taiwan 110, R.O.C.
Phone: +886-2-2727-1221
Fax: +886-2-2727-1223
e-mail:
taiwansales@powerint.com

UK (EUROPE & AFRICA HEADQUARTERS)

1st Floor, St. James's House
East Street
Farnham, Surrey GU9 7TJ
United Kingdom
Phone: +44-1252-730-140
Fax: +44-1252-727-689
e-mail: eurossales@powerint.com

ER or EPR template – Rev 3.4 – Single sided

