



Design Example Report

Title	<i>89% Efficiency, High Power Factor Corrected (>0.98), 10 W Output Non-Isolated Buck LED Driver Using LinkSwitch™-PL LNK460VG</i>
Specification	90 VAC – 135 VAC Input; 36 V _{TYP} , 278 mA Output
Application	A19 LED Driver
Author	Application Engineering Department
Document Number	DER-306
Date	January 17, 2012
Revision	1.0

Summary and Features

- Single-stage power factor correction combined with constant current (CC) output
- Low cost, low component count, small size and single-sided PCB
- Highly energy efficient, >89% at 115 VAC input for 36 V LED Load
- Fast start-up time (<300 ms) – no perceptible delay
- Integrated protection and reliability features
 - Single shot no-load protection / output short-circuit protected with auto-recovery
 - Auto-recovering thermal shutdown with large hysteresis protects both components and PCB
 - No damage during brown-out conditions
- PF >0.98 at 115 VAC
- % ATHD <15% at 115 VAC; 36 V LED
- Meets IEC ring wave, differential line surge and EN55015 conducted EMI

PATENT INFORMATION

The products and applications illustrated herein (including transformer construction and circuits external to the products) may be covered by one or more U.S. and foreign patents, or potentially by pending U.S. and foreign patent applications assigned to Power Integrations. A complete list of Power Integrations' patents may be found at www.powerint.com. Power Integrations grants its customers a license under certain patent rights as set forth at <http://www.powerint.com/ip.htm>.

Table of Contents

1	Introduction.....	4
2	Power Supply Specification	5
3	Schematic.....	6
4	Circuit Description	7
4.1	Input EMI Filtering	7
4.2	Power Circuit.....	7
4.3	Output Feedback.....	7
4.4	Open Load Protection	8
5	PCB Layout	9
6	Bill of Materials	10
7	Inductor Specification	11
7.1	Electrical Diagram	11
7.2	Electrical Specifications.....	11
7.3	Materials.....	11
7.4	Inductor Build Diagram.....	11
7.5	Inductor Construction	11
8	Performance Data	12
8.1	Efficiency.....	12
8.2	Line and Load Regulation.....	13
8.3	Power Factor	14
8.4	A-THD	15
8.5	Harmonics	16
8.5.1	33 V LED Load.....	16
8.5.2	36 V LED Load.....	17
8.5.3	39 V LED Load.....	18
8.6	Test Data.....	19
8.6.1	Test Data, 33 V LED Load	19
8.6.2	Test Data, 36 V LED Load	19
8.6.3	Test Data, 39 V LED Load	19
8.6.4	115 VAC 60 Hz, 33 V LED Load Harmonics Data.....	20
8.6.5	115 VAC 60 Hz, 36 V LED Load Harmonics Data.....	21
8.6.6	115 VAC 60 Hz, 39 V LED Load Harmonics Data.....	22
9	Thermal Performance.....	23
9.1	$V_{IN} = 90$ VAC, 60 Hz, 36 V LED Load.....	23
9.2	$V_{IN} = 100$ VAC, 60 Hz, 36 V LED Load.....	23
9.3	$V_{IN} = 135$ VAC, 60 Hz, 36 V LED Load.....	24
10	Waveforms.....	25
10.1	Input Voltage and Input Current Waveforms	25
10.2	Output Current and Output Voltage at Normal Operation.....	26
10.3	Output Current/Voltage Rise and Fall.....	27
10.4	Input Voltage and Output Current Waveform at Start-up.....	28
10.5	Drain Voltage and Current at Normal Operation.....	29
10.6	Start-up Drain Voltage and Current	30
10.7	Drain Current and Drain Voltage During Output Short Condition	30



10.8	Open Load Output Voltage	31
10.9	Brown-in and Brown-out Condition	32
11	Conducted EMI	33
11.1	Test Set-up	33
11.2	Test Result	34
12	Line Surge	35
13	Revision History	36

Important Note: Although this board is designed to satisfy safety requirements, the engineering prototype has not been agency approved. In addition, this design does not provide galvanic isolation of the output from the AC input. Therefore, all testing should be performed using an isolation transformer to provide the AC input to the prototype board.



1 Introduction

The document describes a non-isolated, high efficiency, high power factor (PF) LED driver designed to drive a nominal LED string voltage of 36 V at 278 mA from an input voltage range of 90 VAC to 135 VAC (47 Hz – 63 Hz). The LED driver utilizes the LNK460VG from the LinkSwitch-PL family of ICs.

The topology used is a single-stage non-isolated buck that meets the stringent space and efficiency requirements for this design. LinkSwitch-PL based designs provide a high power factor (>0.9) meeting international requirements.

This document contains the LED driver specification, schematic, PCB details, bill of materials, transformer documentation and typical performance characteristics.

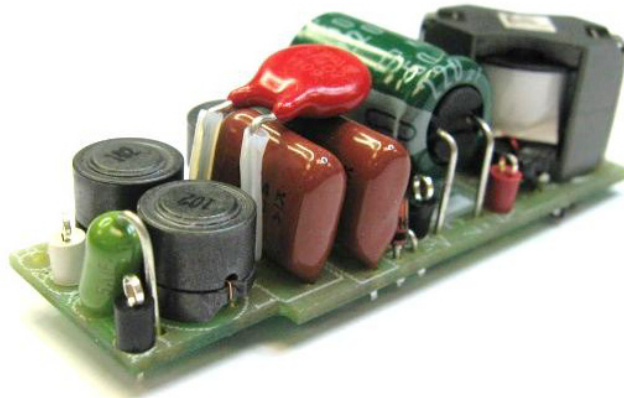

Figure 1 – Populated Circuit Board.

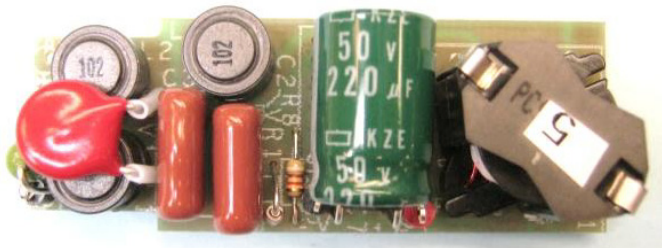

Figure 2 – Populated Circuit Board, Top View.

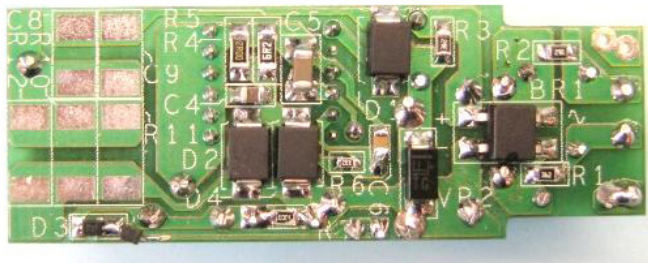

Figure 3 – Populated Circuit Board, Bottom View.



2 Power Supply Specification

The table below represents the minimum acceptable performance of the design. Actual performance is listed in the results section.

Description	Symbol	Min	Typ	Max	Units	Comment
Input Voltage Frequency	V_{IN} f_{LINE}	90	100/115 60	135	VAC Hz	2 Wire – no P.E.
Output Output Voltage Output Current Total Output Power Continuous Output Power	V_{OUT} I_{OUT} P_{OUT}		36 278 10		V mA W	$V_{OUT} = 36\text{ V}$, $V_{IN} = 115\text{ VAC}$, $25\text{ }^{\circ}\text{C}$
Efficiency Full Load	η	88.7	89		%	Measured at P_{OUT} $25\text{ }^{\circ}\text{C}$
Environmental Conducted EMI Safety Ring Wave (100 kHz) Differential Mode (L1-L2) Differential Surge						
			CISPR 15B / EN55015B Non-Isolated			
			2.5		kV	
			1000		V	
Power Factor			0.99			Measured at $V_{OUT(TYP)}$, $I_{OUT(TYP)}$ and 115 VAC, 60 Hz
Harmonic Currents			EN 61000-3-2 Class D (C)			Class C specifies Class D Limits when $P_{IN} < 25\text{ W}$
Ambient Temperature	T_{AMB}		50		$^{\circ}\text{C}$	Free convection, sea level



3 Schematic

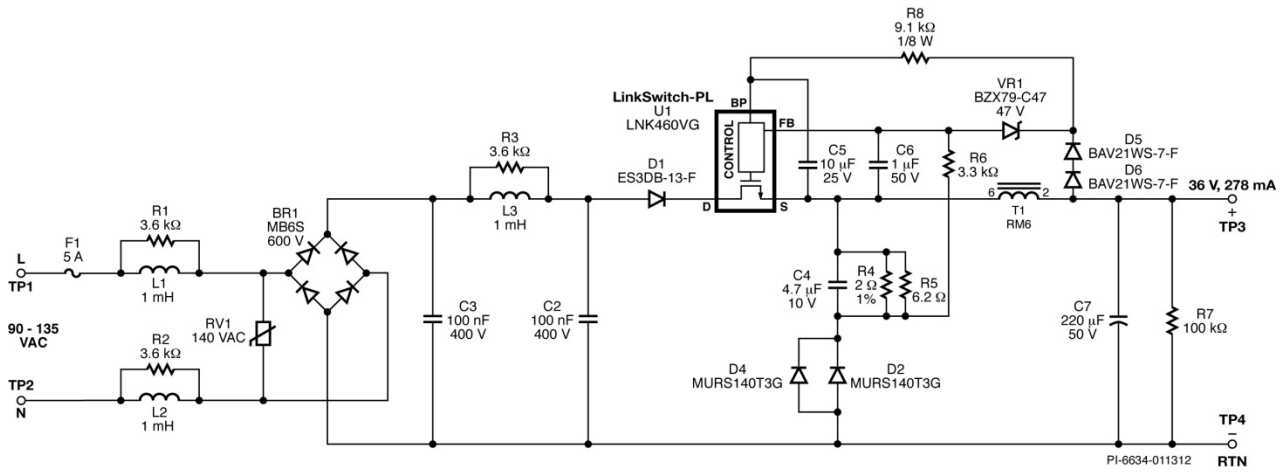

Figure 4 – Schematic.



4 Circuit Description

The LinkSwitch-PL (U1) is a highly integrated primary-side controller intended for use in LED driver applications. The LinkSwitch-PL provides high power factor while regulating the output current across a range of input (90 VAC to 135 VAC) in a single conversion stage. The design also supports the output voltage variations typically encountered in LED driver applications. All of the control circuitry responsible for these functions plus the high-voltage power MOSFET is incorporated into the IC.

4.1 Input EMI Filtering

Inductors L1-L3 and C2-C3 filters the input switching current presented by the buck converter to the line. Resistor R1, R2 and R3 across L1, L2 and L3 damp any resonances between the input inductors, capacitors and the AC line impedance which would ordinarily show up as increased conducted EMI.

MOV RV1 provides a clamp to limit the maximum voltage during differential line surge events. The 140V rating has a clamping voltage of <400 V providing a large margin to the 725 V rating of U1. Bridge rectifier BR1 rectifies the AC line voltage with capacitor C2 providing a low impedance path (decoupling) for the primary switching current. A low value of capacitance (sum of C2 and C3) is necessary to maintain a power factor of greater than 0.9.

4.2 Power Circuit

The circuit is configured as a buck converter with the pin of U1 connected on top of the freewheeling diodes D2 and D4 and DRAIN (D) pin connected to the positive side of the DC rectified input thru D1. Diode D1 is used to prevent reverse current from flowing through U1. An RM6 core size was selected to optimize the inductor for highest system efficiency. C7 is selected to give an output ripple of $\pm 60\%$.

Capacitor C5 provides local decoupling for the BYPASS (BP) pin of U1 which is the supply pin for the internal controller. During start-up, C5 is charged to ~ 6 V from an internal high-voltage current source connected to the DRAIN pin. Once charged U1 starts switching at which point the operating supply current is also provided from the T1 inductor via R8 and D5 and D6.

The series combination of D5 and D6 was used to provide very fast recovery and lower capacitance than a single ultrafast diode. This minimized changes to the FB pin current with load, improving regulation by 5 to 10 mA. A single ultrafast type (e.g. UF4005 or BYV26C) may be substituted for D5 and D6 if regulation is acceptable. Alternatively, if disconnected load protection is not needed, VR1 may be omitted.

4.3 Output Feedback

Resistor R4 and R5 are used to sense the diode current of the buck converter. Its value is adjusted to center the output current at 278 mA at nominal input voltage. Capacitor C4 is used to filter the high frequency component of the diode current which helps improve



overall efficiency. Resistor R6 and C6 provide additional filtering to lower the ripple voltage feed to the FEEDBACK (FB) pin of U1 for improved regulation.

4.4 Open Load Protection

The LED driver is protected in the event of accidental open load operation by monitoring the voltage across the output inductor during energy decay. Zener diode VR1 sets the OVP threshold which forces U1 to enter cycle-skipping mode.

During open load condition, the output capacitor can be charged to a voltage that exceeds the threshold of VR1 because of the leakage current that flows to the output capacitor even when U1 is off. Resistor R7 is used limit the maximum output voltage by partially discharging the output during open load, but the tradeoff being lower efficiency during normal operation.

For designs which require absolute OVP protection for the output capacitor, a Zener diode with Zener voltage greater than or equal to VR1 Zener voltage can be added across the output.



Want More?

Use your smartphone and free software from www.neoreader.com (or any other free QR Code Reader from your smartphone's App Store) and you will be connected to related content



5 PCB Layout

The PCB used is the same as DER-302 with R13 replaced by F1.

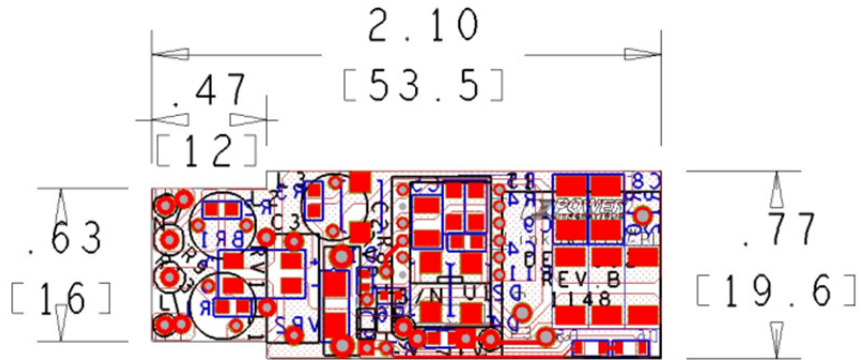

Figure 5 – PCB Layout and Outline (in/[mm]).

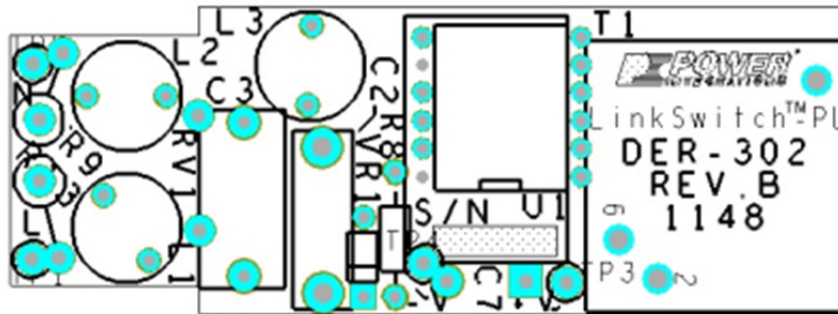

Figure 6 – Top Side.

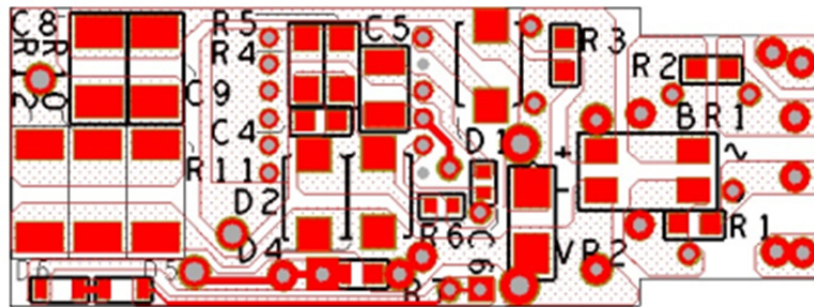

Figure 7 – Bottom Side.

Note: Location D3 in Rev A board is the placeholder for D5 and D6 for units built using Revision A PCB.



6 Bill of Materials

Item	Qty	Ref Des	Description	Mfg Part Number	Manufacturer
1	1	BR1	600 V, 0.5 A, Bridge Rectifier, SMD, MBS-1, 4-SOIC	MB6S-TP	Micro Commercial
2	2	C2 C3	100 nF, 400 V, Film	ECQ-E4104KF	Panasonic
3	1	C4	4.7 μ F, 10 V, Ceramic, X7R, 0805	C0805C475K8PACTU	Kemet
4	1	C5	10 μ F, 25 V, Ceramic, X5R, 1206	ECJ-3YB1E106M	Panasonic
5	1	C6	1 μ F, 50 V, Ceramic, X7R, 0805	08055D105KAT2A	AVX
6	1	C7	220 μ F, 50 V, Electrolytic, Very Low ESR, 42 m Ω , (10 x 16)	EKZE500ELL221MJ16S	Nippon Chemi-Con
7	1	D1	200 V, 3 A, DIODE SUPER FAST SMD, SMB	ES3DB-13-F	Diodes, Inc.
8	2	D2 D4	400 V, 1 A, Ultrafast Recovery, 35 ns, SMB Case	MURS140T3G	On Semi
9	2	D5, D6	250 V, 0.2 A, Fast Switching, 50 ns, SOD-323	BAV21WS-7-F	Diodes, Inc.
10	1	F1	5 A, 250 V, Fast, Microfuse, Axial	0263005.MXL	Littlefuse
11	3	L1 L2 L3	1 mH, 0.23 A, Ferrite Core	CTSCH875DF-102K	CT Parts
12	3	R1 R2 R3	3.6 k Ω , 5%, 1/8 W, Thick Film, 0805	ERJ-6GEYJ362V	Panasonic
13	1	R4	2.00 Ω , 1%, 1/4 W, Thick Film, 1206	MCR18EZHL2R00	Rohm Semi
14	1	R5	6.2 Ω , 5%, 1/4 W, Thick Film, 1206	ERJ-8GEYJ6R2V	Panasonic
15	1	R6	3.3 k Ω , 5%, 1/10 W, Thick Film, 0603	ERJ-3GEYJ332V	Panasonic
16	1	R7	100 k Ω , 5%, 1/8 W, Thick Film, 0805	ERJ-6GEYJ104V	Panasonic
17	1	R8	9.1 k Ω , 5%, 1/8 W, Carbon Film	CFR-12JB-9K1	Yageo
18	1	RV1	140 V, 12 J, 7 mm, RADIAL	V140LA2P	Littlefuse
19	1	T1	Bobbin, RM6, Vertical, 6 pins	B65808-N1006-D1	Epcos
20	1	U1	LinkSwitch-PL, eDIP-12P	LNK460VG	Power Integrations
21	1	VR1	47 V, 500 mW, 5%, DO-35	BZX79-C47	Taiwan Semi



7 Inductor Specification

7.1 Electrical Diagram

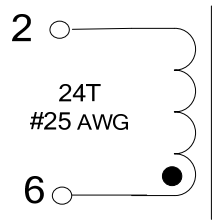

Figure 8 – Inductor Electrical Diagram.

7.2 Electrical Specifications

Primary Inductance	Pins 2-6, all other windings open, measured at 100 kHz, 0.4 V _{RMS}	150 μH ±7%
Resonant Frequency	Pins 2-6, all other windings open	3 MHz (Min.)

7.3 Materials

Item	Description
[1]	Core: TDKPC95RM06-Z.
[2]	Bobbin: B-RM6-V-6pins-(3/3) with mounting clip, CLIP-RM6.
[3]	Tape, Polyester film, 3M 1350F-1 or equivalent, 6.4 mm wide.
[4]	Wire: Magnet, #25 AWG, solderable double coated.

7.4 Inductor Build Diagram

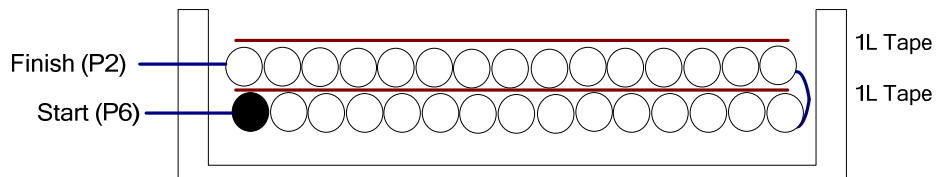

Figure 9 – Inductor Build Diagram.

7.5 Inductor Construction

Bobbin Preparation	Place the bobbin item [2] on the mandrel such that pin side on the left side. Winding direction is the clockwise direction.
WDG 1	Starting at pin 6, wind 24 turns of wire item [4] in two layers. Apply one layer of tape item [3] per layer. Finish at pin 2.
Final Assembly	Grind core to get 150 μH inductance. Cut pins 1, 3, and 5.



8 Performance Data

All measurements performed at room temperature using an LED load. The following data were measured using 3 sets of loads to represent the load range of 33 V ~ 39 V output voltage). Refer to the table on Section 8.6 for the complete set of test data values.

8.1 Efficiency

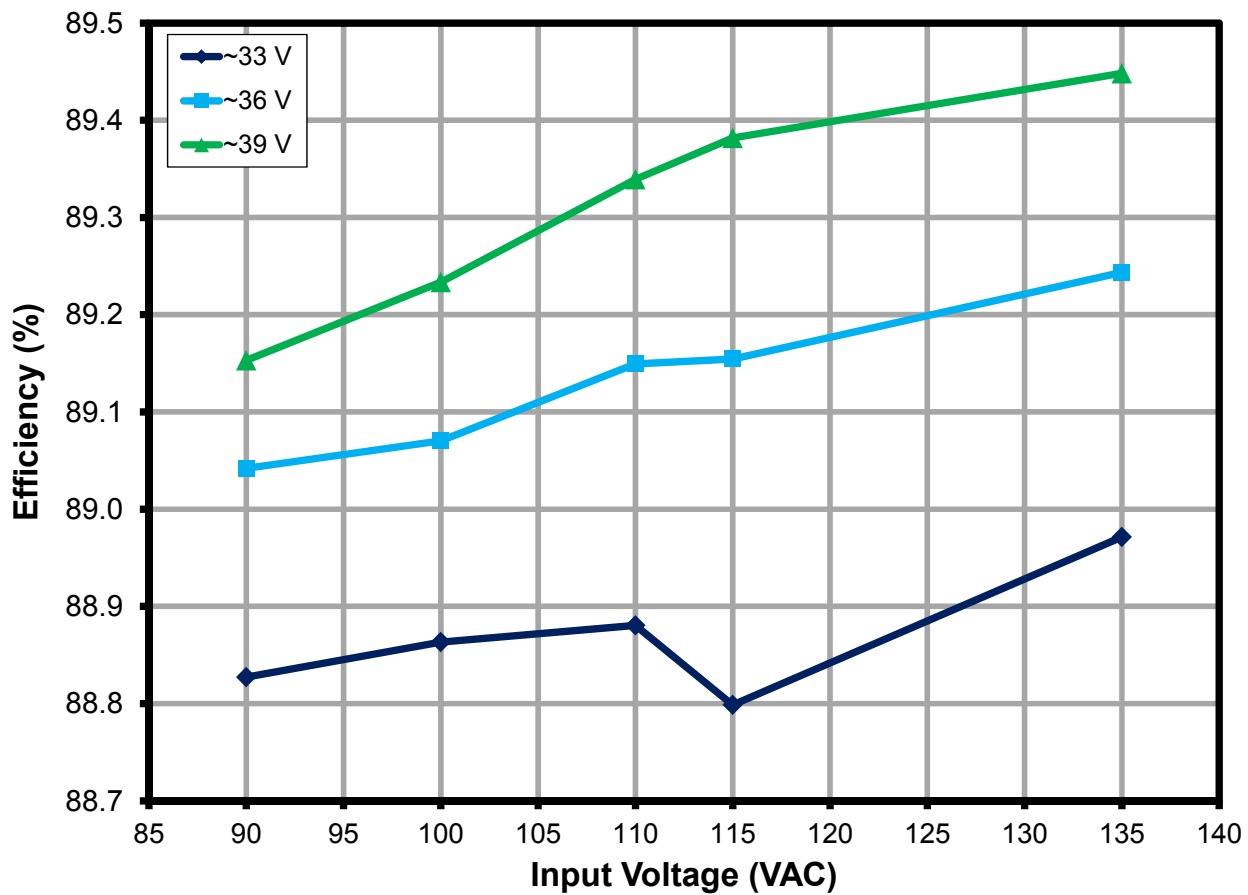

Figure 10 – Efficiency vs. Line and Load.



8.2 Line and Load Regulation

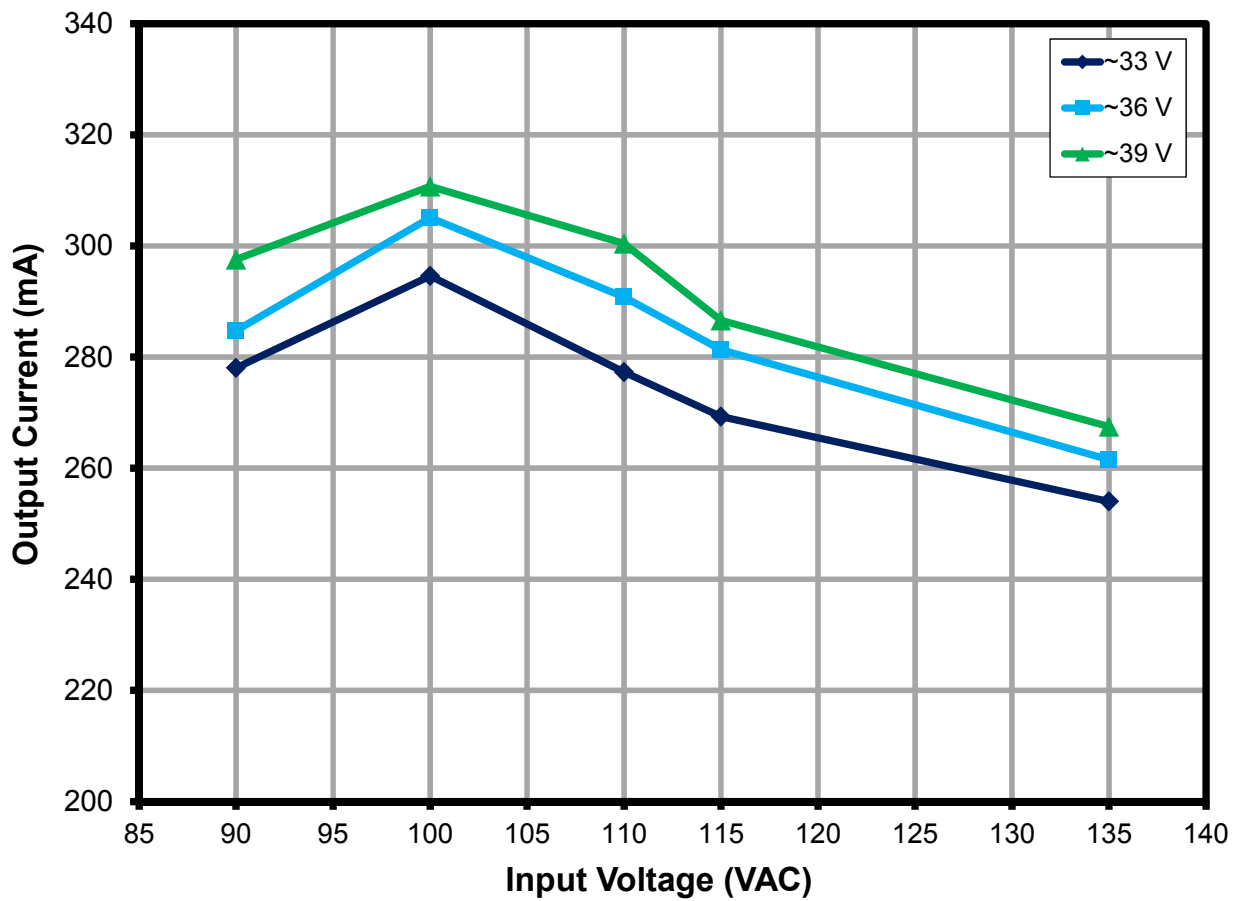

Figure 11 – Regulation vs. Line and Load



8.3 Power Factor

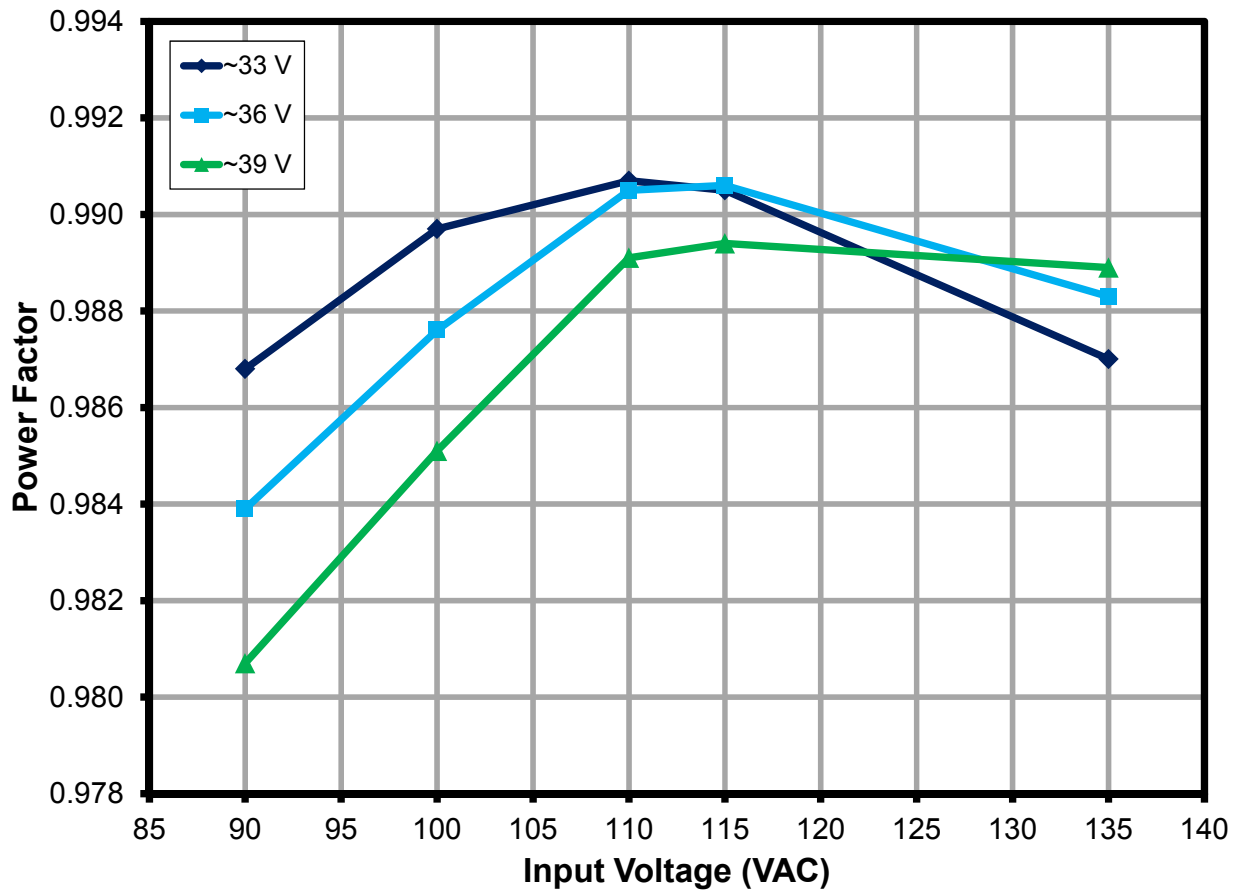

Figure 12 – Power Factor vs. Line and Load.



8.4 A-THD

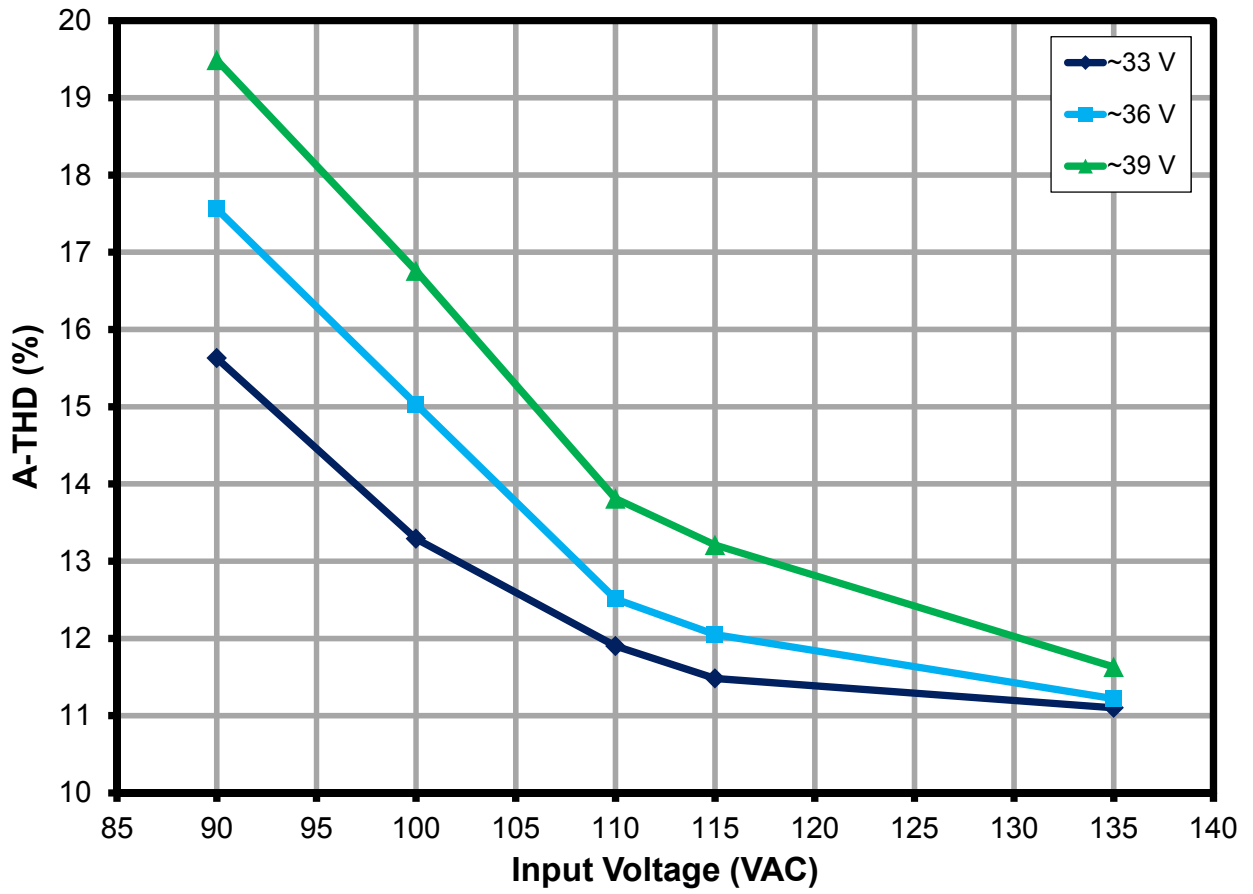

Figure 13 – A-THD vs. Line and Load.



8.5 Harmonics

The design met the limits for Class C equipment for an active input power of <25 W. In this case IEC61000-3-2 specifies that harmonic currents shall not exceed the limits of Class D equipment¹. Therefore the limits shown in the charts below are Class D limits which must not be exceeded to meet Class C compliance.

8.5.1 33 V LED Load

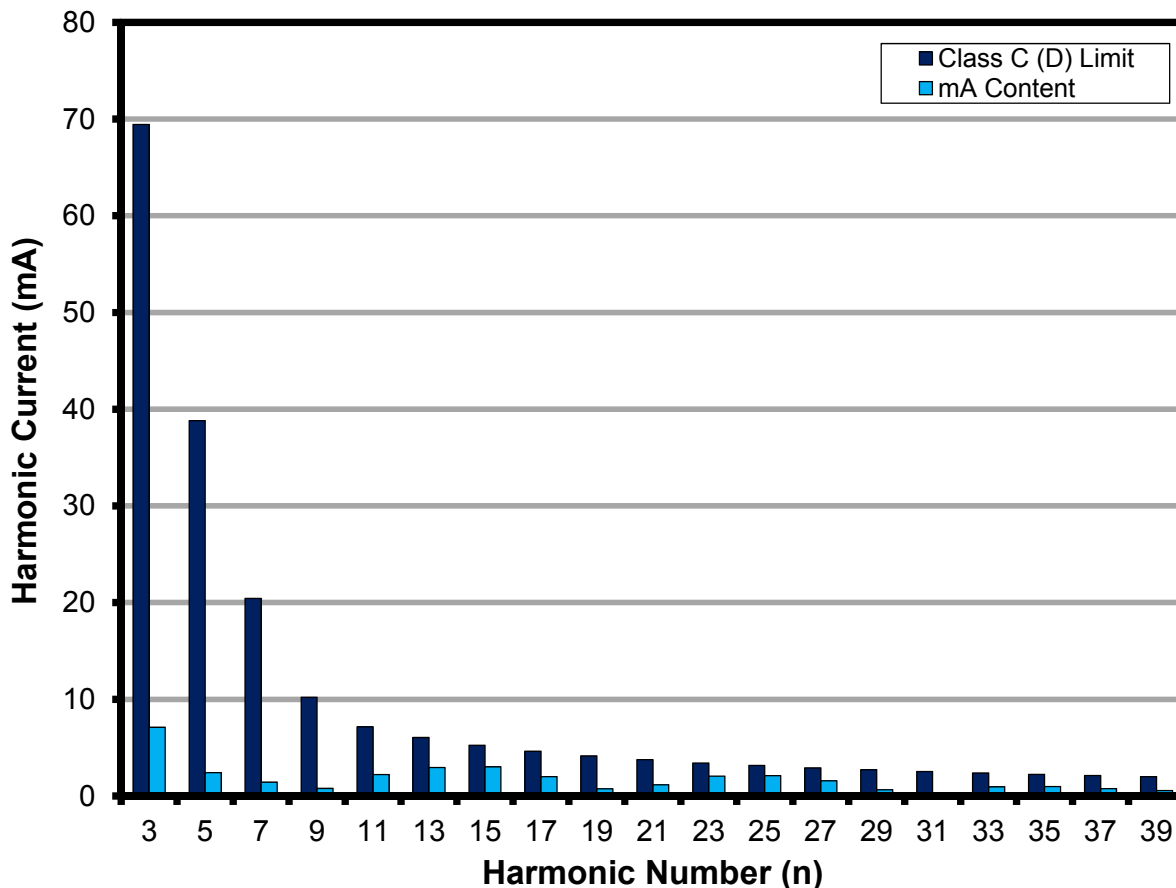

Figure 14 – 33 V LED Load Input Current Harmonics at 115 VAC, 60 Hz.

¹ IEC6000-3-2 Section 7.3, table 2, column 2.



8.5.2 36 V LED Load

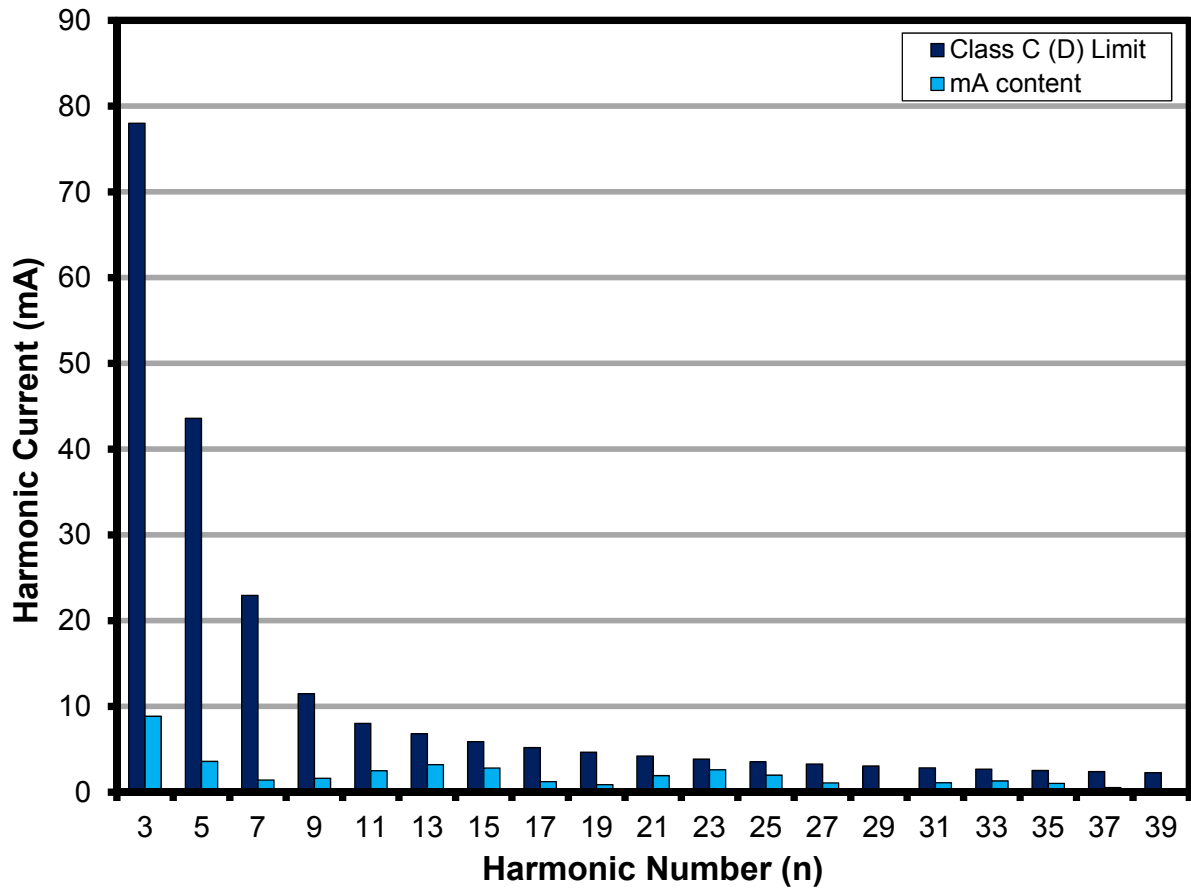

Figure 15 – 36 V LED Load Input Current Harmonics at 115 VAC, 60 Hz.



8.5.3 39 V LED Load

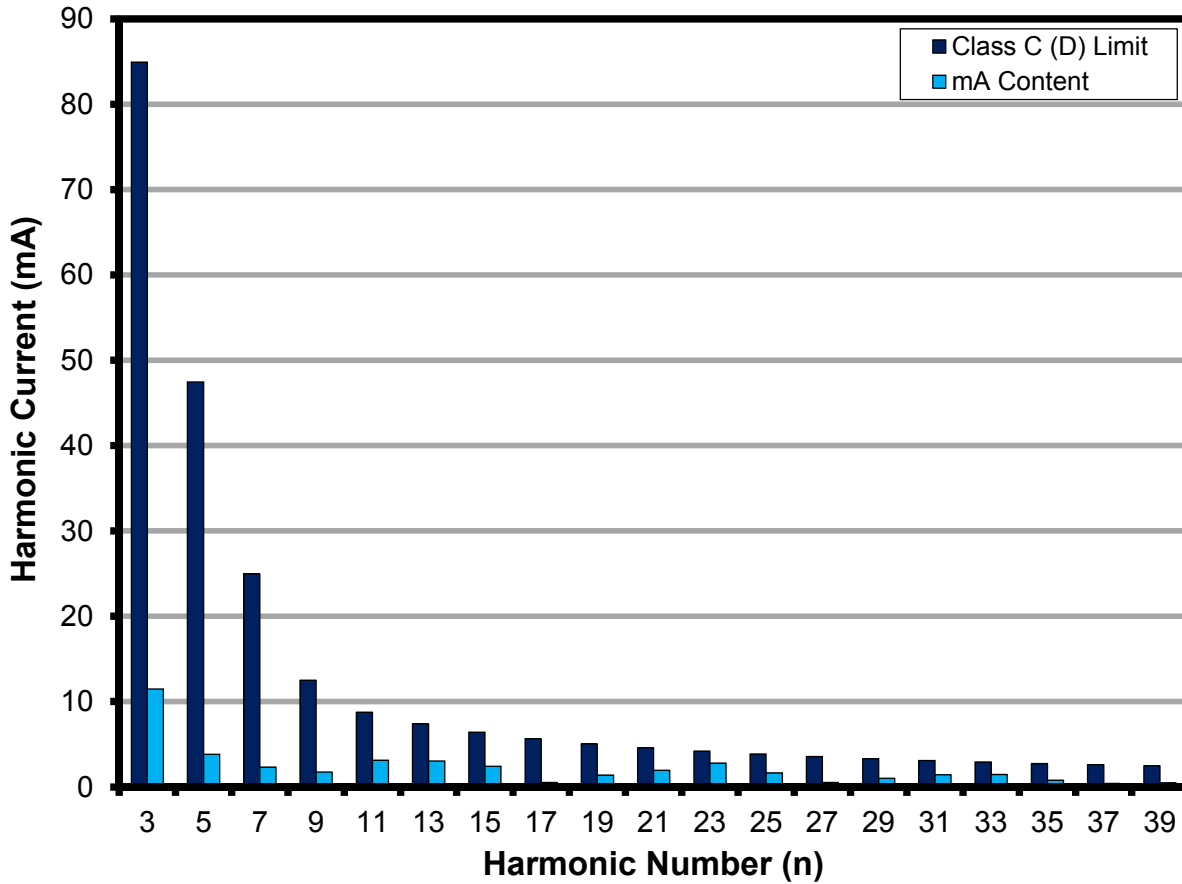

Figure 16 – 39 V LED Load Input Current Harmonics at 115 VAC, 60 Hz.



8.6 Test Data

All measurements were taken with the board at open frame, 25 °C ambient, and 60 Hz line frequency.

8.6.1 Test Data, 33 V LED Load

Input Measurement					Load Measurement			Calculation			
V _{IN} (V _{RMS})	I _{IN} (mA _{RMS})	P _{IN} (W)	PF	%ATHD	V _{OUT} (V _{DC})	I _{OUT} (mA _{DC})	P _{OUT} (W)	P _{CAL} (W)	Efficiency (%)	Loss (W)	
90.04	119.46	10.615	0.987	15.63	33.45	278.06	9.43	9.30	88.83	1.19	
100.01	113.85	11.269	0.990	13.29	33.52	294.58	10.01	9.87	88.86	1.26	
110.07	96.66	10.540	0.991	11.9	33.37	277.27	9.37	9.25	88.88	1.17	
115.06	89.61	10.213	0.991	11.48	33.28	269.27	9.07	8.96	88.80	1.14	
135.08	71.74	9.566	0.987	11.1	33.15	253.99	8.51	8.42	88.97	1.06	

8.6.2 Test Data, 36 V LED Load

Input Measurement					Load Measurement			Calculation			
V _{IN} (V _{RMS})	I _{IN} (mA _{RMS})	P _{IN} (W)	PF	%ATHD	V _{OUT} (V _{DC})	I _{OUT} (mA _{DC})	P _{OUT} (W)	P _{CAL} (W)	Efficiency (%)	Loss (W)	
90.03	131.96	11.690	0.984	17.56	36.07	284.77	10.41	10.27	89.04	1.28	
100.00	127.19	12.562	0.988	15.03	36.18	305.08	11.19	11.04	89.07	1.37	
110.07	109.13	11.898	0.991	12.51	36.04	290.79	10.61	10.48	89.15	1.29	
115.05	100.64	11.470	0.991	12.05	35.93	281.31	10.23	10.11	89.15	1.24	
135.08	79.32	10.589	0.988	11.22	35.76	261.54	9.45	9.35	89.24	1.14	

8.6.3 Test Data, 39 V LED Load

Input Measurement					Load Measurement			Calculation			
V _{IN} (V _{RMS})	I _{IN} (mA _{RMS})	P _{IN} (W)	PF	%ATHD	V _{OUT} (V _{DC})	I _{OUT} (mA _{DC})	P _{OUT} (W)	P _{CAL} (W)	Efficiency (%)	Loss (W)	
90.03	148.17	13.082	0.981	19.49	38.69	297.57	11.66	11.51	89.15	1.42	
100.00	138.79	13.672	0.985	16.76	38.75	310.72	12.20	12.04	89.23	1.47	
110.06	120.80	13.151	0.989	13.81	38.65	300.43	11.75	11.61	89.34	1.40	
115.05	109.70	12.488	0.989	13.21	38.52	286.59	11.16	11.04	89.38	1.33	
135.08	86.69	11.581	0.989	11.63	38.35	267.50	10.36	10.26	89.45	1.22	



8.6.4 115 VAC 60 Hz, 33 V LED Load Harmonics Data

V	Freq	I (mA)	P	PF	%THD
115	60.00	89.61	10.2130	0.9905	11.48
nth Order	mA Content	% Content	Limit <25 W	Limit >25 W	Remarks
1	88.88				
2	0.04	0.05%		2.00%	
3	7.11	8.00%	69.4484	29.72%	Pass
5	2.42	2.72%	38.8094	10.00%	Pass
7	1.44	1.62%	20.4260	7.00%	Pass
9	0.78	0.88%	10.2130	5.00%	Pass
11	2.21	2.49%	7.1491	3.00%	Pass
13	2.96	3.33%	6.0492	3.00%	Pass
15	3.01	3.39%	5.2427	3.00%	Pass
17	2.00	2.25%	4.6259	3.00%	Pass
19	0.74	0.83%	4.1390	3.00%	Pass
21	1.15	1.29%	3.7448	3.00%	Pass
23	2.05	2.31%	3.4191	3.00%	Pass
25	2.10	2.36%	3.1456	3.00%	Pass
27	1.56	1.76%	2.9126	3.00%	Pass
29	0.65	0.73%	2.7117	3.00%	Pass
31	0.23	0.26%	2.5368	3.00%	Pass
33	0.96	1.08%	2.3830	3.00%	Pass
35	0.98	1.10%	2.2469	3.00%	Pass
37	0.77	0.87%	2.1254	3.00%	Pass
39	0.55	0.62%	2.0164	3.00%	Pass
41	0.44	0.50%			
43	0.58	0.65%			
45	0.15	0.17%			
47	0.16	0.18%			
49	0.26	0.29%			



8.6.5 115 VAC 60 Hz, 36 V LED Load Harmonics Data

V	Freq	I (mA)	P	PF	%THD
115	60.00	100.64	11.4700	0.9906	12.05
nth Order	mA Content	% Content	Limit <25 W	Limit >25 W	Remarks
1	99.90				
2	0.07	0.07%		2.00%	
3	8.85	8.86%	77.9960	29.72%	Pass
5	3.58	3.58%	43.5860	10.00%	Pass
7	1.40	1.40%	22.9400	7.00%	Pass
9	1.61	1.61%	11.4700	5.00%	Pass
11	2.51	2.51%	8.0290	3.00%	Pass
13	3.20	3.20%	6.7938	3.00%	Pass
15	2.81	2.81%	5.8879	3.00%	Pass
17	1.24	1.24%	5.1952	3.00%	Pass
19	0.88	0.88%	4.6484	3.00%	Pass
21	1.92	1.92%	4.2057	3.00%	Pass
23	2.61	2.61%	3.8400	3.00%	Pass
25	1.99	1.99%	3.5328	3.00%	Pass
27	1.08	1.08%	3.2711	3.00%	Pass
29	0.10	0.10%	3.0455	3.00%	Pass
31	1.09	1.09%	2.8490	3.00%	Pass
33	1.32	1.32%	2.6763	3.00%	Pass
35	1.03	1.03%	2.5234	3.00%	Pass
37	0.52	0.52%	2.3870	3.00%	Pass
39	0.37	0.37%	2.2646	3.00%	Pass
41	0.76	0.76%			
43	0.53	0.53%			
45	0.23	0.23%			
47	0.21	0.21%			
49	0.47	0.47%			



8.6.6 115 VAC 60 Hz, 39 V LED Load Harmonics Data

V	Freq	I (mA)	P	PF	%THD
115	60.00	109.70	12.4880	0.9894	13.21
nth Order	mA Content	% Content	Limit <25 W	Limit >25 W	Remarks
1	108.71				
2	0.07	0.06%		2.00%	
3	11.49	10.57%	84.9184	29.68%	Pass
5	3.82	3.51%	47.4544	10.00%	Pass
7	2.33	2.14%	24.9760	7.00%	Pass
9	1.75	1.61%	12.4880	5.00%	Pass
11	3.12	2.87%	8.7416	3.00%	Pass
13	3.05	2.81%	7.3967	3.00%	Pass
15	2.43	2.24%	6.4105	3.00%	Pass
17	0.53	0.49%	5.6563	3.00%	Pass
19	1.39	1.28%	5.0609	3.00%	Pass
21	1.96	1.80%	4.5789	3.00%	Pass
23	2.78	2.56%	4.1808	3.00%	Pass
25	1.65	1.52%	3.8463	3.00%	Pass
27	0.53	0.49%	3.5614	3.00%	Pass
29	1.03	0.95%	3.3158	3.00%	Pass
31	1.43	1.32%	3.1019	3.00%	Pass
33	1.47	1.35%	2.9139	3.00%	Pass
35	0.78	0.72%	2.7474	3.00%	Pass
37	0.41	0.38%	2.5989	3.00%	Pass
39	0.49	0.45%	2.4656	3.00%	Pass
41	0.68	0.63%			
43	0.67	0.62%			
45	0.39	0.36%			
47	0.40	0.37%			
49	0.16	0.15%			



9 Thermal Performance

Images captured after running for >30 minutes at room temperature (25 °C), open frame for the conditions specified.

9.1 $V_{IN} = 90 \text{ VAC}, 60 \text{ Hz}, 36 \text{ V LED Load}$

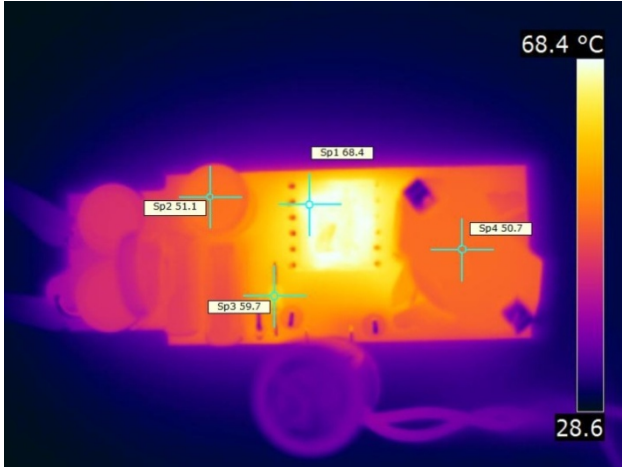

Figure 17 – Top Side.
U1- LNK460VG: 68.4 °C.

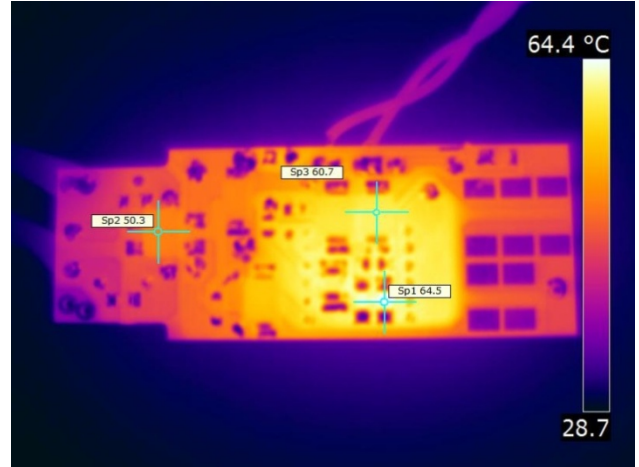

Figure 18 – Bottom Side.
R4- Current Sense Resistor: 64.5 °C.

9.2 $V_{IN} = 100 \text{ VAC}, 60 \text{ Hz}, 36 \text{ V LED Load}$

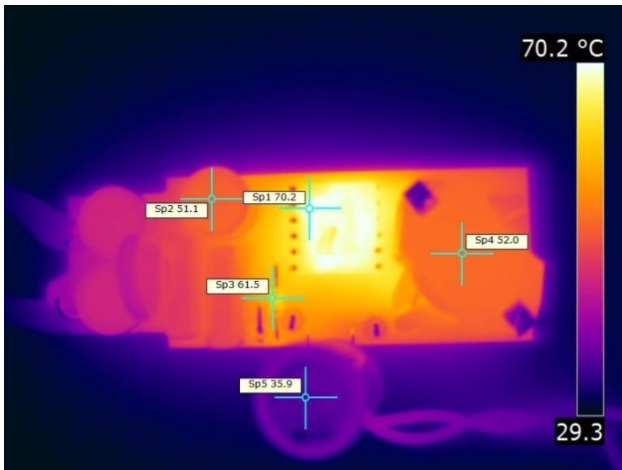

Figure 19 – Top Side.
U1- LNK460VG: 70.2 °C.

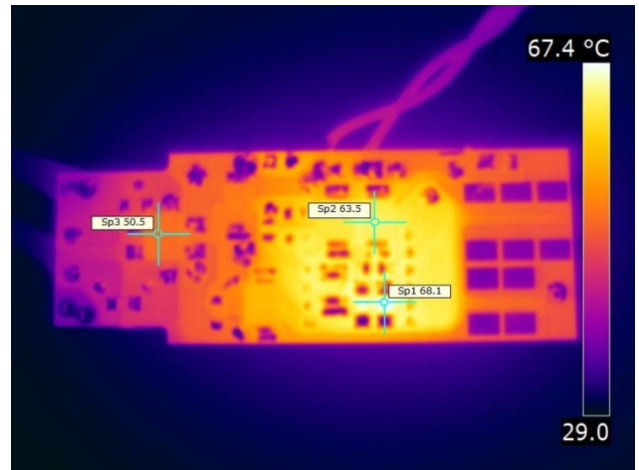

Figure 20 – Bottom Side.
R4- Current Sense Resistor: 68.1 °C.



9.3 $V_{IN} = 135 \text{ VAC}, 60 \text{ Hz}, 36 \text{ V LED Load}$

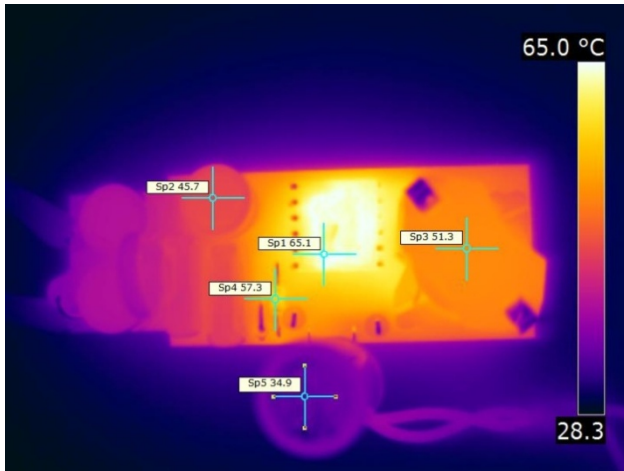

Figure 21 – Top Side.
U1-LNK460VG: 65.1 °C.

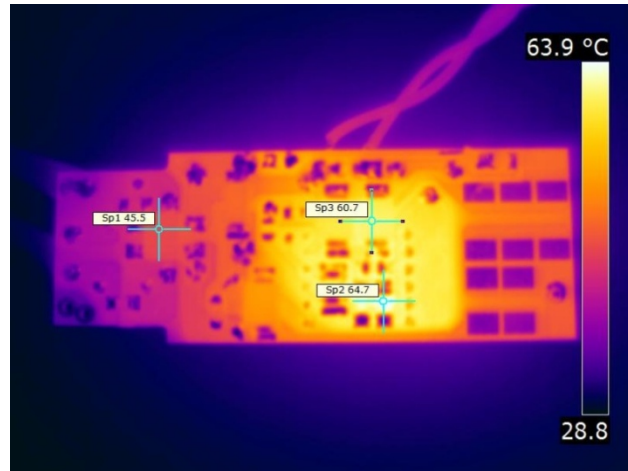

Figure 22 – Bottom Side.
R4- Current Sense Resistor: 64.7 °C.

10 Waveforms

10.1 Input Voltage and Input Current Waveforms

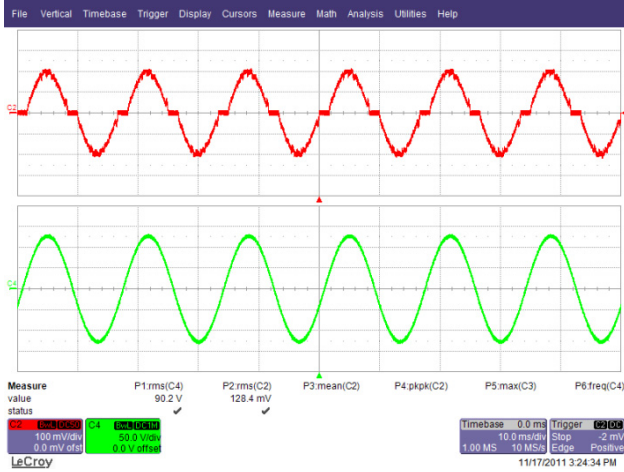

Figure 23 – 90 VAC, Full Load.
Upper: I_{IN} , 100 mA / div.
Lower: V_{IN} , 50 V, 10 ms / div.

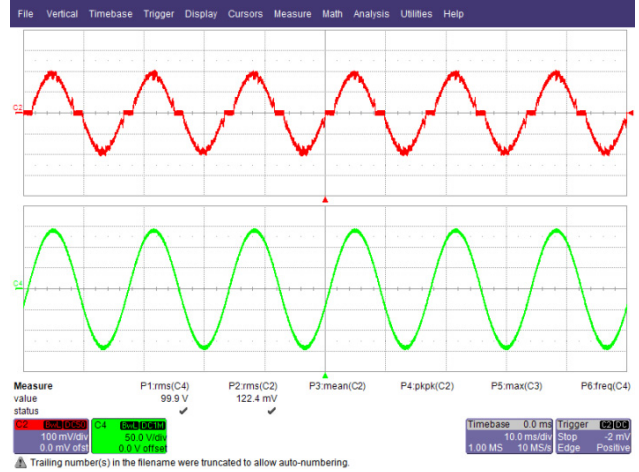

Figure 24 – 100 VAC, Full Load.
Upper: I_{IN} , 100 mA / div.
Lower: V_{IN} , 50 V, 10 ms / div.

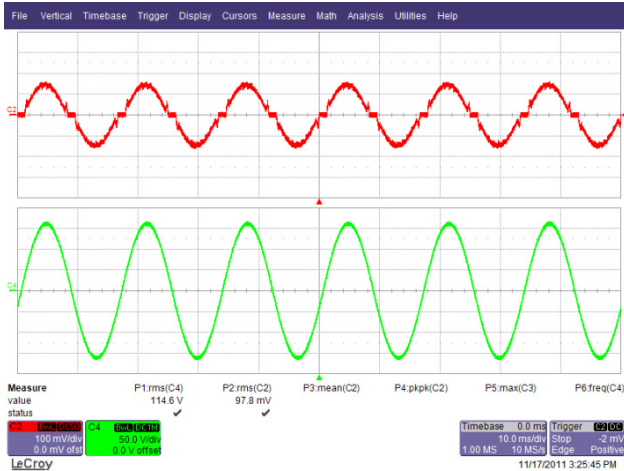

Figure 25 – 115 VAC, Full Load.
Upper: I_{IN} , 100 mA / div.
Lower: V_{IN} , 50 V, 10 ms / div.

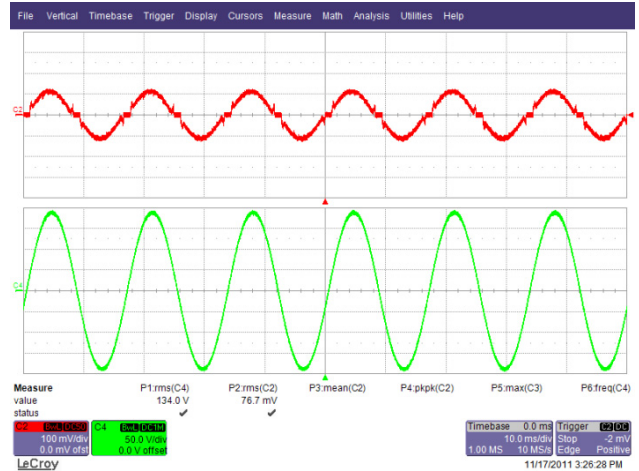

Figure 26 – 135 VAC, Full Load.
Upper: I_{IN} , 100 mA / div.
Lower: V_{IN} , 50 V, 10 ms / div.



10.2 Output Current and Output Voltage at Normal Operation

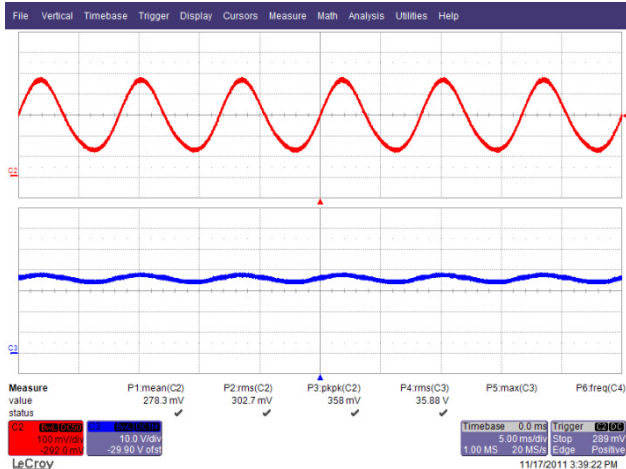

Figure 27 – 90 VAC, 60 Hz Full Load.
Upper: I_{OUT} , 100 mA / div.
Lower: V_{OUT} , 10 V, 5 ms / div.

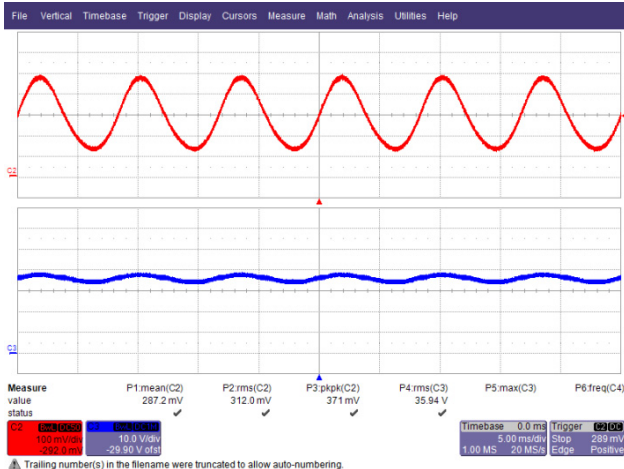

Figure 28 – 100 VAC, 60 Hz Full Load.
Upper: I_{OUT} , 100 mA / div.
Lower: V_{OUT} , 10 V, 5 ms / div.

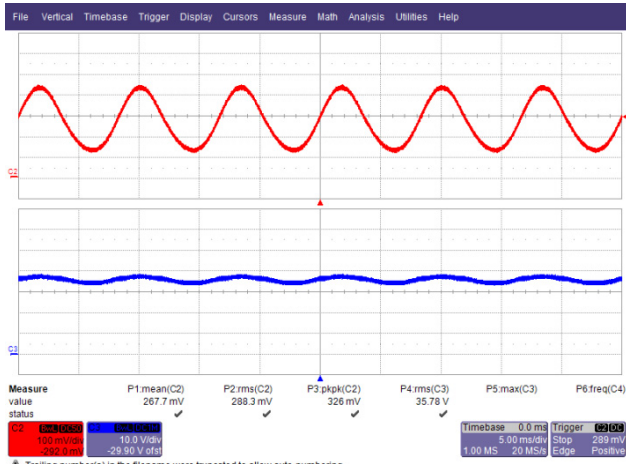

Figure 29 – 115 VAC, 60 Hz Full Load.
Upper: I_{OUT} , 100 mA / div.
Lower: V_{OUT} , 10 V, 5 ms / div.

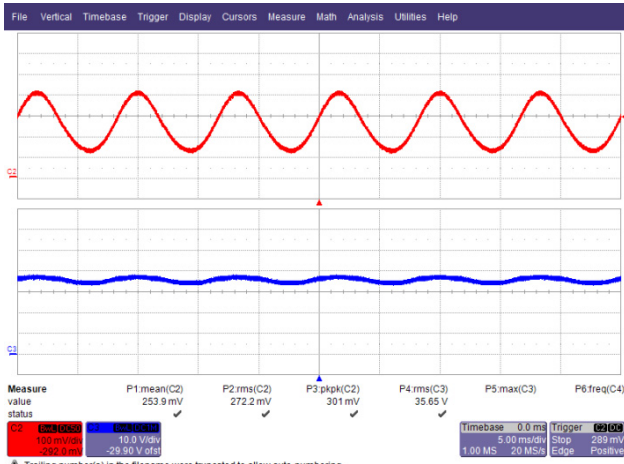

Figure 30 – 135 VAC, 60 Hz Full Load.
Upper: I_{OUT} , 100 mA / div.
Lower: V_{OUT} , 10 V, 5 ms / div.



10.3 Output Current/Voltage Rise and Fall

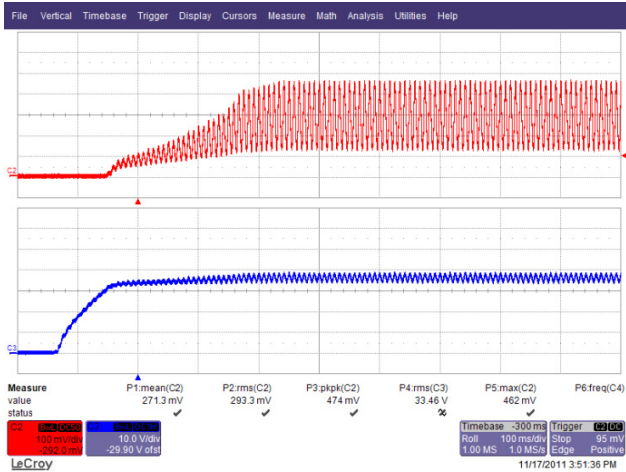

Figure 31 – 90 VAC Output Rise.
 Upper: I_{OUT} , 100 mA / div.
 Lower: V_{OUT} , 10 V, 100 ms / div.

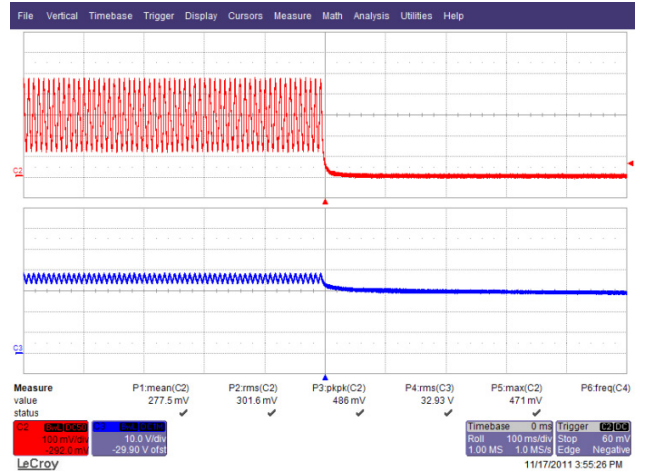

Figure 32 – 90 VAC Output Fall.
 Upper: I_{OUT} , 100 mA / div.
 Lower: V_{OUT} , 10 V, 100 ms / div.

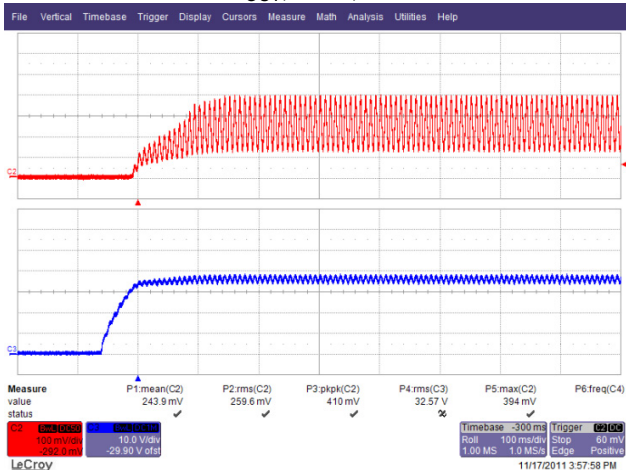

Figure 33 – 135 VAC Output Rise.
 Upper: I_{OUT} , 100 mA / div.
 Lower: V_{OUT} , 10 V, 100 ms / div.

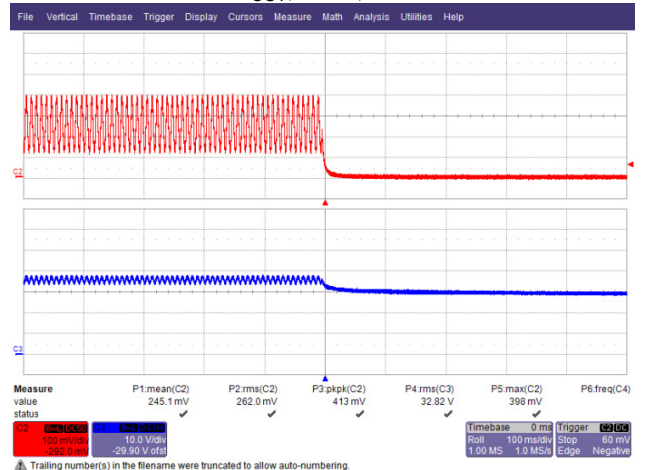

Figure 34 – 135 VAC Output Fall.
 Upper: I_{OUT} , 100 mA / div.
 Lower: V_{OUT} , 10 V, 100 ms / div.



10.4 Input Voltage and Output Current Waveform at Start-up

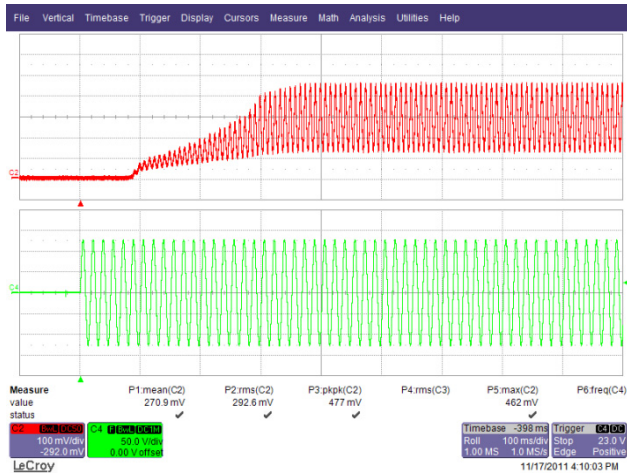

Figure 35 – 90 VAC, 60 Hz.
 Upper: I_{OUT} , 0.1 A / div.
 Lower: V_{IN} , 50 V, 100 ms / div.

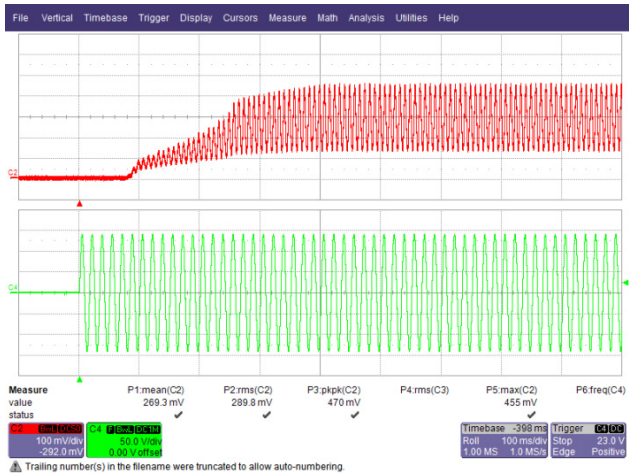

Figure 36 – 100 VAC, 60 Hz.
 Upper: I_{OUT} , 0.1 A / div.
 Lower: V_{IN} , 50 V, 100 ms / div.

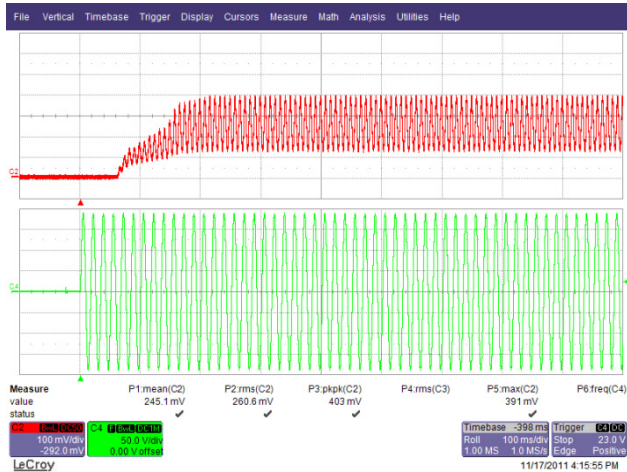

Figure 37 – 115 VAC, 60 Hz.
 Upper: I_{OUT} , 0.1 A / div.
 Lower: V_{IN} , 50 V, 100 ms / div.

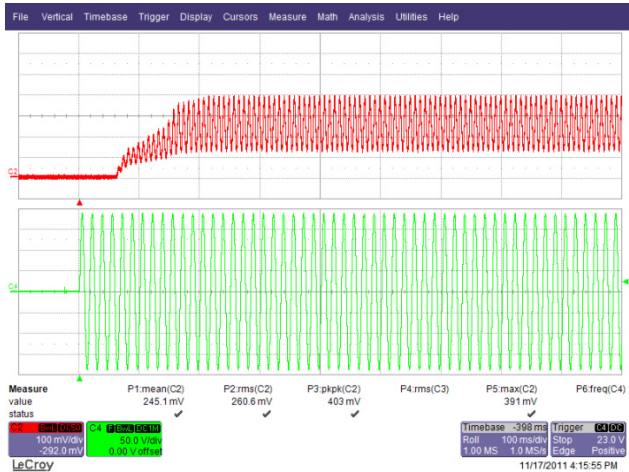

Figure 38 – 135 VAC, 60 Hz.
 Upper: I_{OUT} , 0.1 A / div.
 Lower: V_{IN} , 50 V, 100 ms / div.



10.5 Drain Voltage and Current at Normal Operation

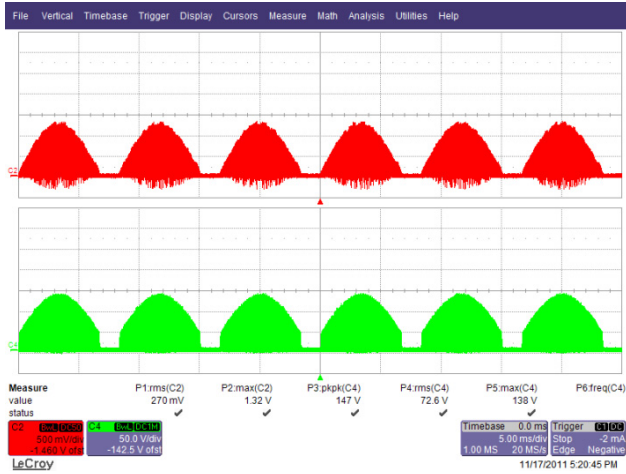

Figure 39 – 90 VAC, 60 Hz.
 Upper: I_{DRAIN} , 500 mA / div.
 Lower: V_{DRAIN} , 50 V, 5 ms / div.

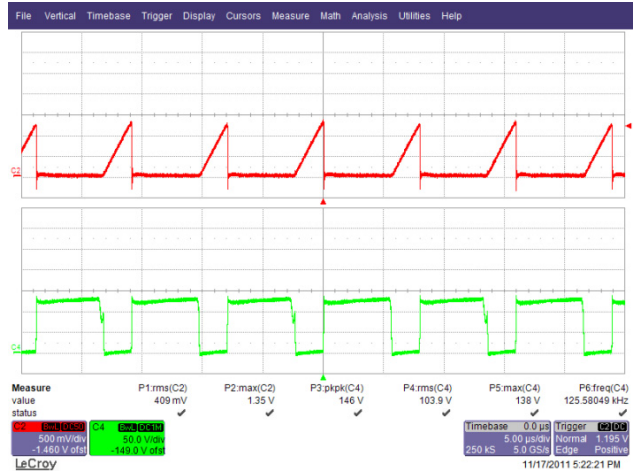

Figure 40 – 90 VAC, 60 Hz.
 Upper: I_{DRAIN} , 500 mA / div.
 Lower: V_{DRAIN} , 50 V, 5 μs / div.

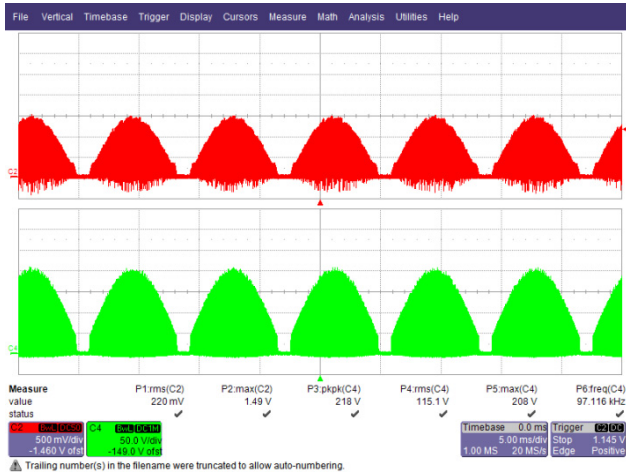

Figure 41 – 135 VAC, 60 Hz.
 Upper: I_{DRAIN} , 500 mA / div.
 Lower: V_{DRAIN} , 50 V, 5 ms / div.



Figure 42 – 135 VAC, 60 Hz.
 Upper: I_{DRAIN} , 500 mA / div.
 Lower: V_{DRAIN} , 50 V, 5 μs / div.

10.6 Start-up Drain Voltage and Current

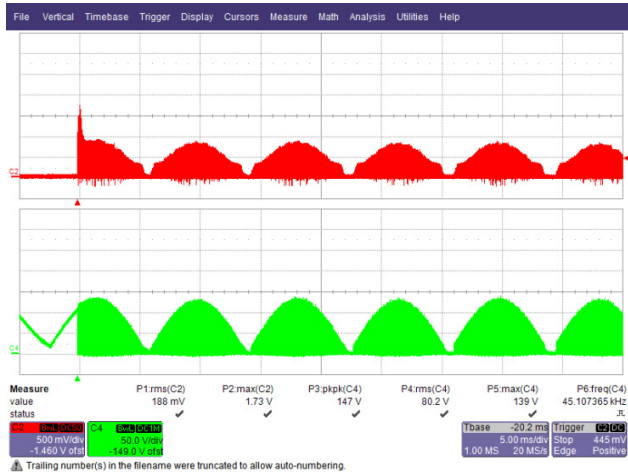

Figure 43 – 90 VAC, 60 Hz.
 Upper: I_{DRAIN} , 500 mA / div.
 Lower: V_{DRAIN} , 50 V, 5 ms / div.

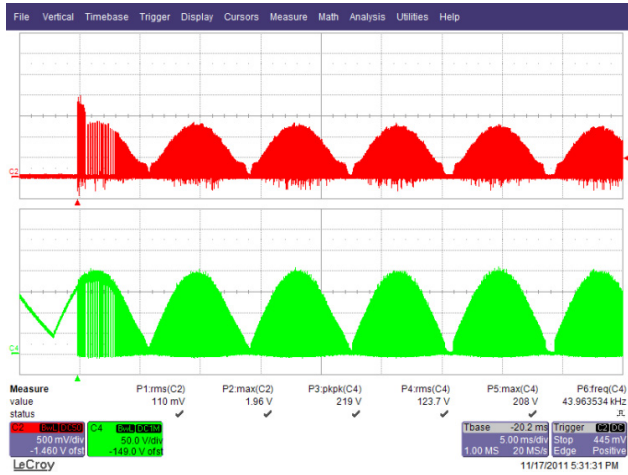

Figure 44 – 135 VAC, 60 Hz.
 Upper: I_{DRAIN} , 500 mA / div.
 Lower: V_{DRAIN} , 50 V, 5 ms / div.

10.7 Drain Current and Drain Voltage During Output Short Condition

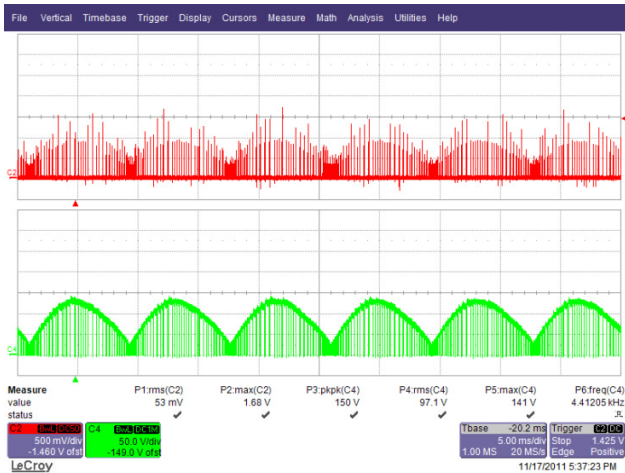

Figure 45 – 90 VAC, 60 Hz Output Short Condition.
 Upper: I_{DRAIN} , 500 mA / div.
 Lower: V_{DRAIN} , 50 V, 5 ms / div.

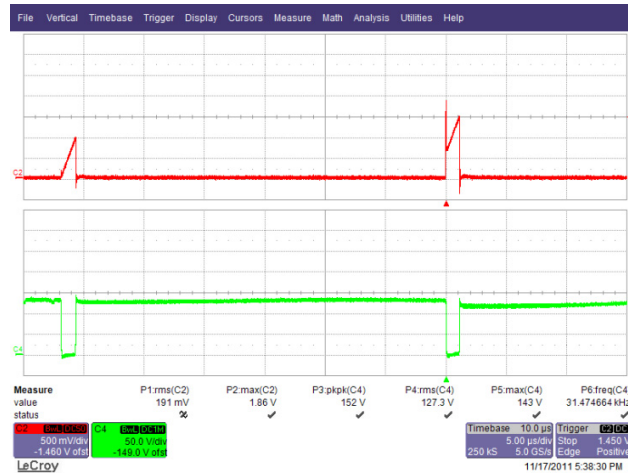

Figure 46 – 90 VAC, 60 Hz Output Short Condition.
 Upper: I_{DRAIN} , 500 mA / div.
 Lower: V_{DRAIN} , 50 V, 5 μs / div.



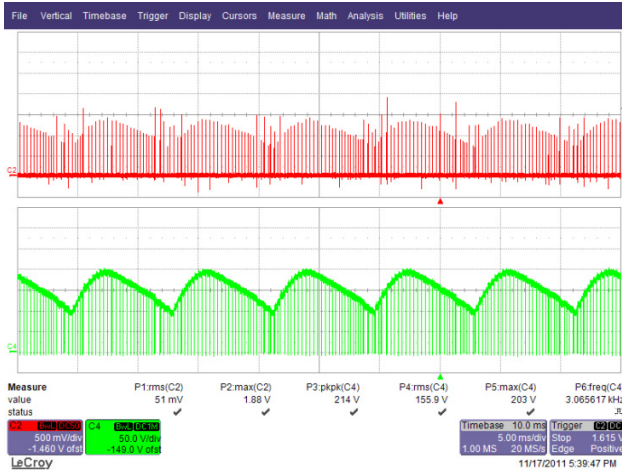

Figure 47 – 135 VAC, 60 Hz Output Short Condition.
Upper: I_{DRAIN} , 500 mA / div.
Lower: V_{DRAIN} , 50 V, 5 ms / div.

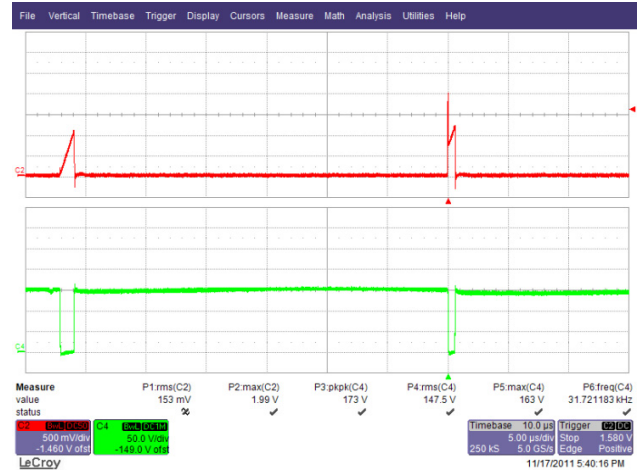

Figure 48 – 135 VAC, 60 Hz Output Short Condition.
Upper: I_{DRAIN} , 500 mA / div.
Lower: V_{DRAIN} , 50 V, 5 μ s / div.

10.8 Open Load Output Voltage

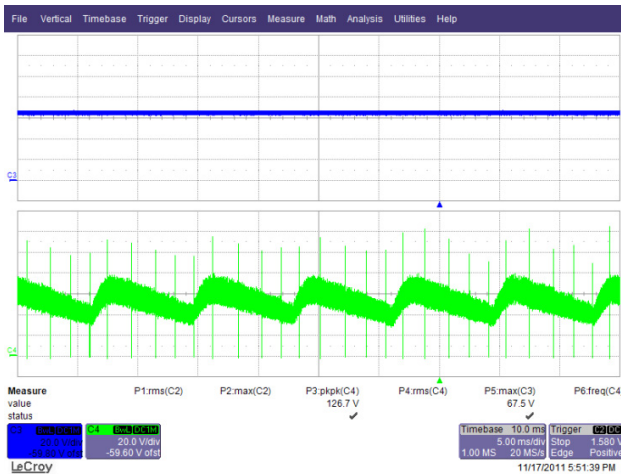

Figure 49 – 90 VAC, 60 Hz Open Load Characteristic.
Upper: V_{OUT} , 20 V / div.
Lower: V_{DRAIN} , 20 V / div., 5 ms / div.

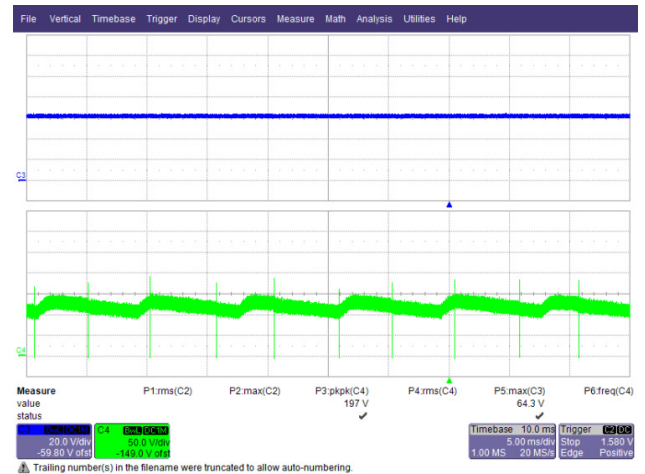

Figure 50 – 135 VAC, 60 Hz Open Load Characteristic.
Upper: V_{OUT} , 20 V / div.
Lower: V_{DRAIN} , 50 V / div., 5 ms / div.

The 50 V rating of the output cap is exceeded during open load condition. To improve OVP performance, a Zener equivalent to VR1 can be placed across the output to improve clamping. Less than 100 mW of dissipation were also measured across the Zener during this condition.

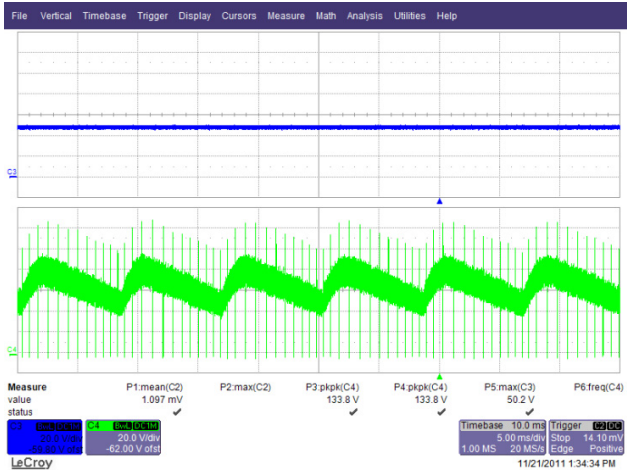

Figure 51 – 90 VAC, 60 Hz Open Load Characteristic with 47 V Zener Across Output.
 Upper: V_{OUT} , 20 V / div.
 Lower: V_{DRAIN} , 20 V / div., 5ms / div.

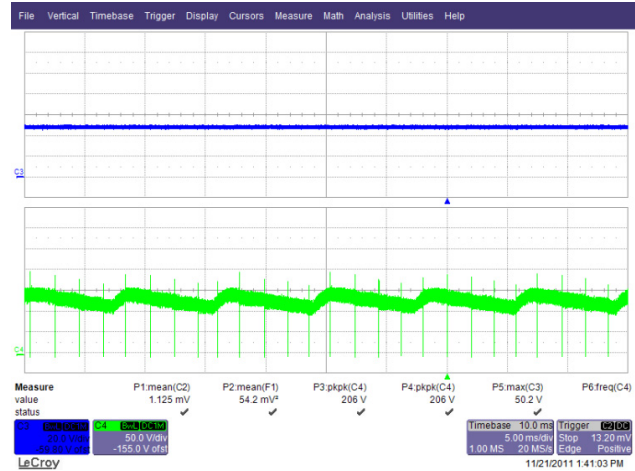

Figure 52 – 135 VAC, 60 Hz Open Load Characteristic with 47 V Zener Across Output.
 Upper: V_{OUT} , 20 V / div.
 Lower: V_{DRAIN} , 50 V / div., 5ms / div.

10.9 Brown-in and Brown-out Condition

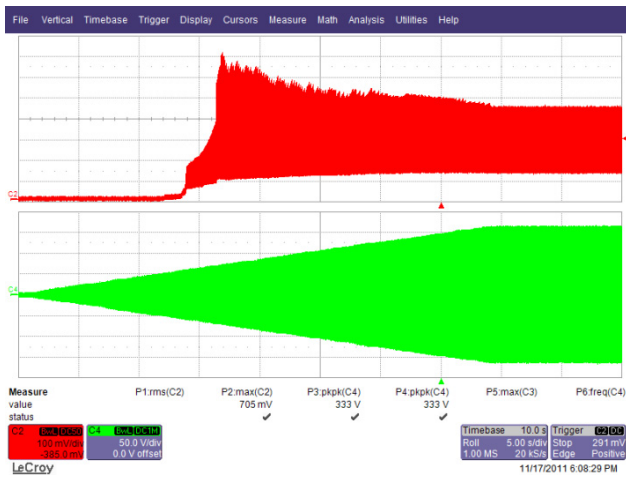

Figure 53 – 0 VAC – 115 VAC, 3 V / μ s Slew Rate.
 Upper: I_{OUT} , 100 mA / div.
 Lower: V_{INAC} , 50 V, 5 s / div.

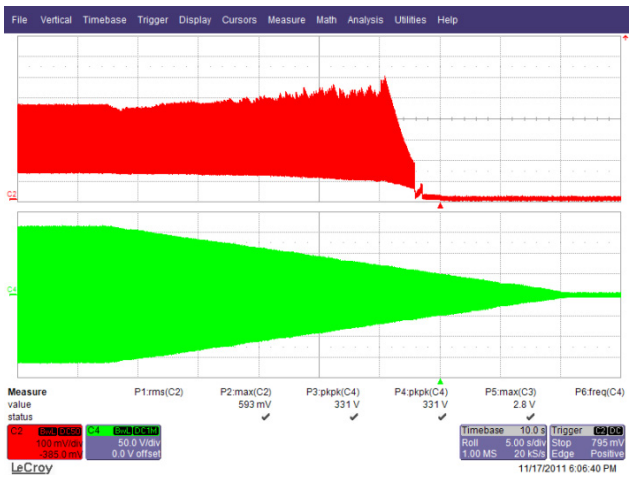

Figure 54 – 115 VAC – 0 VAC, 3 V / μ s Slew Rate.
 Upper: I_{OUT} , 100 mA / div.
 Lower: V_{INAC} , 50 V, 5 s / div.



11 Conducted EMI

11.1 Test Set-up

The unit was tested using LED load (36 V V_{OUT}) with input voltage of 115 VAC, 60 Hz at room temperature.



Figure 55 – EMI Test Set-up With the Unit and LED Load Placed Inside the Cone.

11.2 Test Result



EDIT PEAK LIST (Final Measurement Results)

Trace1: EN55015Q
Trace2: EN55015A
Trace3: ---

TRACE	FREQUENCY	LEVEL dBµV	DELTA	LIMIT dB
1 Quasi Peak	165.693318812 kHz	56.30	L1 gnd	-8.86
2 Average	221.118376275 kHz	43.32	L1 gnd	-9.44
2 Average	332.507282579 kHz	40.34	L1 gnd	-9.03
2 Average	443.732257589 kHz	36.62	L1 gnd	-10.37
1 Quasi Peak	452.651275966 kHz	47.33	L1 gnd	-9.48
1 Quasi Peak	767.002111284 kHz	44.95	N gnd	-11.04
2 Average	767.002111284 kHz	33.01	N gnd	-12.98
1 Quasi Peak	890.465639904 kHz	46.26	L1 gnd	-9.73
2 Average	890.465639904 kHz	33.39	L1 gnd	-12.60
2 Average	983.628047757 kHz	32.83	L1 gnd	-13.17
1 Quasi Peak	1.00339897152 MHz	46.06	L1 gnd	-9.93
1 Quasi Peak	1.33903981723 MHz	44.73	N gnd	-11.26
2 Average	1.33903981723 MHz	31.99	N gnd	-14.00
1 Quasi Peak	1.42141774845 MHz	44.21	N gnd	-11.78
2 Average	1.42141774845 MHz	31.40	N gnd	-14.59
2 Average	1.55458365781 MHz	32.71	L1 gnd	-13.29
1 Quasi Peak	1.58583078933 MHz	46.24	L1 gnd	-9.75
2 Average	1.89688749553 MHz	35.73	N gnd	-10.26
1 Quasi Peak	1.91585637048 MHz	49.00	N gnd	-6.99
1 Quasi Peak	2.03372014292 MHz	46.61	N gnd	-9.38

Figure 56 – Conducted EMI, 36 V LED Load, 115 VAC, 60 Hz, and EN55015 B Limits.



12 Line Surge

The unit was subjected to ± 2500 V 100 kHz ring wave and ± 1 kV differential surge at 115 VAC using 10 strikes at each condition. A test failure was defined as a non-recoverable interruption of output requiring supply repair or recycling of input voltage.

Level (V)	Input Voltage (VAC)	Injection Location	Injection Phase (°)	Type	Test Result (Pass/Fail)
+2500	115	L1, L2	0	100 kHz Ring Wave (500 A)	Pass
-2500	115	L1, L2	0	100 kHz Ring Wave (500 A)	Pass
+2500	115	L1, L2	90	100 kHz Ring Wave (500 A)	Pass
-2500	115	L1, L2	90	100 kHz Ring Wave (500 A)	Pass

Level (kV)	Input Voltage (VAC)	Injection Location	Injection Phase (°)	Type	Test Result (Pass/Fail)
+1 kV	115	L1, L2	0	Surge (2 Ω)	Pass
-1 kV	115	L1, L2	0	Surge (2 Ω)	Pass
+1 kV	115	L1, L2	90	Surge (2 Ω)	Pass
-1 kV	115	L1, L2	90	Surge (2 Ω)	Pass

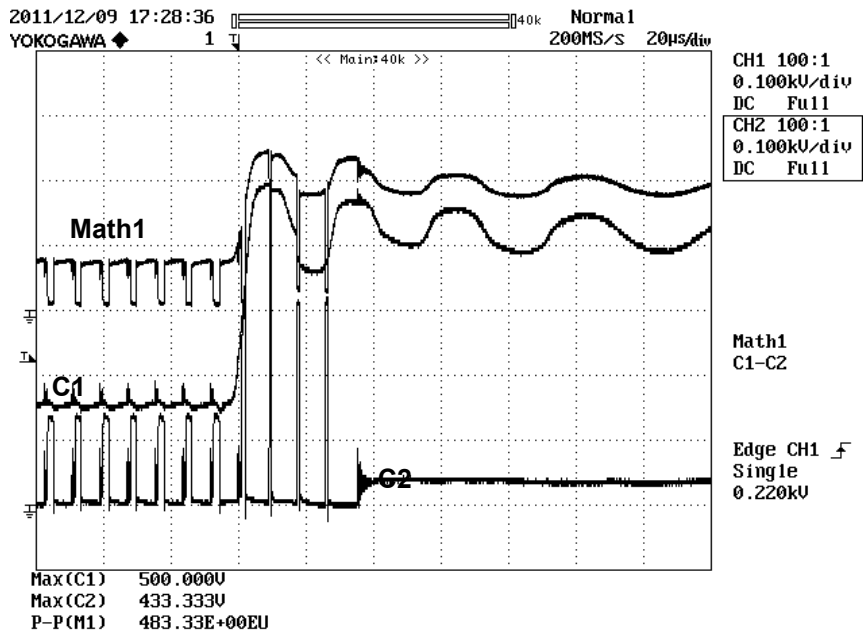

Figure 57 – 1 kV (90° Injection Phase) Differential Surge VDS Waveforms.

Math1: U1 VDS maximum voltage of <500 V.

C1:U1 Drain Voltage Reference to Output Return.

C2: U1 Source Voltage Reference to Output Return.



13 Revision History

Date	Author	Revision	Description and Changes	Reviewed
17-Jan-12	CA	1.0	Initial Release	Apps & Mktg



For the latest updates, visit our website: www.powerint.com

Power Integrations reserves the right to make changes to its products at any time to improve reliability or manufacturability. Power Integrations does not assume any liability arising from the use of any device or circuit described herein. POWER INTEGRATIONS MAKES NO WARRANTY HEREIN AND SPECIFICALLY DISCLAIMS ALL WARRANTIES INCLUDING, WITHOUT LIMITATION, THE IMPLIED WARRANTIES OF MERCHANTABILITY, FITNESS FOR A PARTICULAR PURPOSE, AND NON-INFRINGEMENT OF THIRD PARTY RIGHTS.

PATENT INFORMATION

The products and applications illustrated herein (including transformer construction and circuits' external to the products) may be covered by one or more U.S. and foreign patents, or potentially by pending U.S. and foreign patent applications assigned to Power Integrations. A complete list of Power Integrations' patents may be found at www.powerint.com. Power Integrations grants its customers a license under certain patent rights as set forth at <http://www.powerint.com/ip.htm>.

The PI Logo, TOPSwitch, TinySwitch, LinkSwitch, DPA-Switch, PeakSwitch, CAPZero, SENZero, LinkZero, HiperPFS, HiperTFS, HiperLCS, Qspeed, EcoSmart, Clampless, E-Shield, Filterfuse, StackFET, PI Expert and PI FACTS are trademarks of Power Integrations, Inc. Other trademarks are property of their respective companies. ©Copyright 2011 Power Integrations, Inc.

Power Integrations Worldwide Sales Support Locations

WORLD HEADQUARTERS

5245 Hellyer Avenue
San Jose, CA 95138, USA.
Main: +1-408-414-9200
Customer Service:
Phone: +1-408-414-9665
Fax: +1-408-414-9765
e-mail:
usasales@powerint.com

GERMANY

Rueckertstrasse 3
D-80336, Munich
Germany
Phone: +49-89-5527-3911
Fax: +49-89-5527-3920
e-mail:
eurosales@powerint.com

JAPAN

Kosei Dai-3 Building
2-12-11, Shin-Yokohama,
Kohoku-ku, Yokohama-shi,
Kanagawa 222-0033
Japan
Phone: +81-45-471-1021
Fax: +81-45-471-3717
e-mail: japansales@powerint.com

TAIWAN

5F, No. 318, Nei Hu Rd., Sec. 1
Nei Hu District
Taipei 114, Taiwan R.O.C.
Phone: +886-2-2659-4570
Fax: +886-2-2659-4550
e-mail:
taiwansales@powerint.com

CHINA (SHANGHAI)

Rm 1601/1610, Tower 1
Kerry Everbright City
No. 218 Tianmu Road West
Shanghai, P.R.C. 200070
Phone: +86-021-6354-6323
Fax: +86-021-6354-6325
e-mail:
chinasales@powerint.com

INDIA

#1, 14th Main Road
Vasanthanagar
Bangalore-560052
India
Phone: +91-80-4113-8020
Fax: +91-80-4113-8023
e-mail:
indiasales@powerint.com

KOREA

RM 602, 6FL
Korea City Air Terminal B/D, 159-6
Samsung-Dong, Kangnam-Gu,
Seoul, 135-728
Korea
Phone: +82-2-2016-6610
Fax: +82-2-2016-6630
e-mail: koreasales@powerint.com

EUROPE HQ

1st Floor, St. James's House
East Street, Farnham
Surrey GU9 7TJ
United Kingdom
Phone: +44 (0) 1252-730-141
Fax: +44 (0) 1252-727-689
e-mail:
eurosales@powerint.com

CHINA (SHENZHEN)

3rd Floor, Block A, Zhongtuo
International Business Center,
No. 1061, Xiang Mei Road,
FuTian District, ShenZhen,
China, 518040
Phone: +86-755-8379-3243
Fax: +86-755-8379-5828
e-mail:
chinasales@powerint.com

ITALY

Via De Amicis 2
20091 Bresso MI
Italy
Phone: +39-028-928-6000
Fax: +39-028-928-6009
e-mail:
eurosales@powerint.com

SINGAPORE

51 Newton Road,
#19-01/05 Goldhill Plaza
Singapore, 308900
Phone: +65-6358-2160
Fax: +65-6358-2015
e-mail:
singaporesales@powerint.com

APPLICATIONS HOTLINE

World Wide +1-408-414-9660

APPLICATIONS FAX

World Wide +1-408-414-9760

