



Design Example Report

Title	<i>1.32 W Power Supply Using LNK304DG</i>
Specification	85 VAC – 265 VAC Input; 12 V, 110 mA Output
Application	Small Appliance
Author	Applications Engineering Department
Document Number	DER-231
Date	September 24, 2009
Revision	1.0

Summary and Features

- Non-isolated buck converter
- Low cost 1.32 W capacitor dropper replacement SMPS
- Very low no-load power
- High efficiency over full range of input voltage
- Fully protected against open loop faults, output overload, short circuit, and thermal overload
- Operation at 66 kHz switching frequency, with frequency jittering reduces overall EMI
- Easily meets new and existing energy efficiency standards

PATENT INFORMATION

The products and applications illustrated herein (including transformer construction and circuits external to the products) may be covered by one or more U.S. and foreign patents, or potentially by pending U.S. and foreign patent applications assigned to Power Integrations. A complete list of Power Integrations' patents may be found at www.powerint.com. Power Integrations grants its customers a license under certain patent rights as set forth at <http://www.powerint.com/ip.htm>.

Table of Contents

1 Introduction..... 3

2 Power Supply Specification 4

3 Schematic..... 5

4 Circuit Description 6

4.1 Input Stage and EMI Filtering 6

4.2 LinkSwitch-TN 6

4.3 Output Rectification 7

4.4 Output Feedback..... 7

5 PCB Layout 8

6 Bill of Materials 9

7 Transformer Design Spreadsheet..... 10

8 Performance Data 12

8.1 Zero Load Input Power 12

8.2 Efficiency 13

8.3 Regulation 14

8.3.1 Output Load and Line Regulation..... 14

9 Thermal Performance 15

10 Waveforms..... 16

10.1 Drain Voltage and Inductor Current, Normal Operation, No-load 16

10.2 Drain Voltage and Inductor Current, Normal Operation..... 16

10.3 Output Voltage Start-up Profile..... 17

10.4 Drain Voltage and Inductor Current Start-up Profile 17

10.5 Output Ripple Measurements..... 18

10.5.1 Ripple Measurement Technique 18

Measurement Results..... 19

11 Conducted EMI Measurements..... 20

11.1 Input 115 VAC Full Load 20

11.2 Input 230 VAC Full Load 21

12 Revision History 22

Important Note:

Although this board was designed to satisfy safety isolation requirements, it has not been agency approved. Therefore, all testing should be performed using an isolation transformer to provide the AC input to the power supply.



1 Introduction

This document is an engineering report describing a 12 V, 110 mA non-isolated buck converter utilizing a LinkSwitch-TN LNK304DG. The design is intended to be used for small appliance and metering applications.

The document contains the power supply specification, schematic, bill of materials, and performance data.



Figure 1 – Populated Circuit Board.

2 Power Supply Specification

The table below represents the minimum acceptable performance of the design. Actual performance is listed in the results section.

Description	Symbol	Min	Typ	Max	Units	Comment
Input						
Voltage	V_{IN}	85		265	VAC	2 Wire – no P.E.
Frequency	f_{LINE}	47	50/60	64	Hz	
No-load Input Power (230 VAC)					mW	
Output						
Output Voltage 1	V_{OUT1}	10.8	12	13.2	V	± 10% 20 MHz bandwidth
Output Ripple Voltage 1	$V_{RIPPLE1}$				mV	
Output Current 1	I_{OUT1}		110		mA	
Total Output Power						
Continuous Output Power	P_{OUT}		1.32		W	
Efficiency	η_{FL}	70			%	Full load, nominal line (115 / 230 VAC)
Environmental						
Conducted EMI		EN55022B				
Ambient Temperature	T_{AMB}	0		50	°C	



3 Schematic

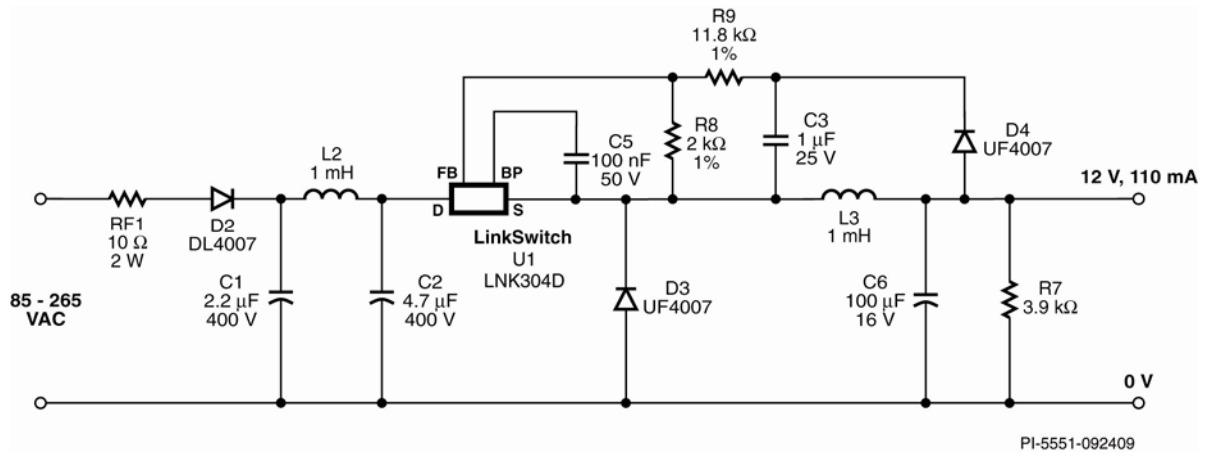

Figure 2 – Schematic.



4 Circuit Description

The schematic in Figure 2 shows a buck converter using LNK304DG. The circuit provides a non-isolated 12 V, 110 mA continuous output. In metering applications this is used to supply the control circuits and micro controller.

LinkSwitch-TN integrates a 700 V MOSFET and control circuitry into a single low cost IC. The device is completely self-powered from the DRAIN pin with local supply decoupling provided by a small 100 nF capacitor (C5) connected on the BP Pin. Regulation is achieved using a low cost resistor divider feedback network.

The switching frequency jitter feature of the LinkSwitch-TN family and the 66 kHz switching frequency of operation helps further reduce EMI.

4.1 Input Stage and EMI Filtering

The input stage is comprised of fusible resistor RF1, diode D2, capacitors C1 and C2, and inductor L2. Resistor RF1 is a flameproof, fusible, wire-wound resistor. It accomplishes several functions: (a) limits inrush current to safe levels for rectifiers D1, (b) provides differential mode noise attenuation and (c) acts as an input fuse in the event any other component fails short circuit. As this component is used as a fuse, it should fail safely open-circuit without emitting smoke, fire or incandescent material to meet typical safety requirements. To withstand the instantaneous inrush power dissipation, wire wound types are recommended. Metal film resistors are not recommended.

4.2 LinkSwitch-TN

LinkSwitch-TN integrates a 700 V power MOSFET and control circuitry into a single low cost IC. The device is completely self-powered from the DRAIN pin with local supply decoupling provided by a small 100 nF capacitor (C5) connected to the BYPASS pin.

Here, the device is configured in a buck converter. The supply is designed to operate in mostly discontinuous conduction mode (MDCM), with the peak L1 inductor current set by the LNK304DG internal current limit. The control scheme used is similar to the ON/OFF control used in TinySwitch. The on-time for each switching cycle is set by the inductance value of L3, LinkSwitch-TN current limit and the high voltage DC input bus across C2. Output regulation is accomplished by skipping switching cycles in response to an ON/OFF feedback signal applied to the FEEDBACK (FB) pin. This differs significantly from traditional PWM schemes that control the duty factor (duty cycle) of each switching cycle.

Unlike TinySwitch, the logic of the FB pin has been inverted in LinkSwitch-TN. This allows a very simple feedback scheme to be used when the device is used in the buck converter configuration. Current into the FB pin greater than 49 μ A will inhibit the switching of the internal MOSFET, while current below this allows switching cycles to occur.



4.3 Output Rectification

During the ON time of U1, current ramps in L3 and is simultaneously delivered to the load. During the OFF time the inductor current ramps down via free-wheeling diode D3 into C6 and is delivered to the load. Diode D3 should be selected as an ultra-fast diode ($t_{rr} < 75$ ns) with a voltage rating greater than the maximum DC voltage across C2 (400 V in this case). In designs that operate in continuous conduction mode, t_{rr} of 35 ns or better is recommended. Capacitor C6 should be selected to have an adequate ripple current rating (low ESR type).

4.4 Output Feedback

The voltage across L3 is rectified and smoothed by D4 and C3 during the off-time of U1. To a first order, the forward voltage drops of D3 and D4 are identical and therefore, the voltage across C3 tracks the output voltage. To provide a feedback signal, the voltage developed across C3 is divided by R8 and R9 and connected to U1's FB pin. The values of R8 and R9 are selected such that at the nominal output voltage, the voltage on the FB pin is 1.65 V. This voltage is specified for U1 at an FB pin current of 49 μ A with a tolerance of +/-7% over a temperature range of -40 to 125 °C. This allows this simple feedback to meet the required overall output tolerance of +/-10% at rated output current.



5 PCB Layout

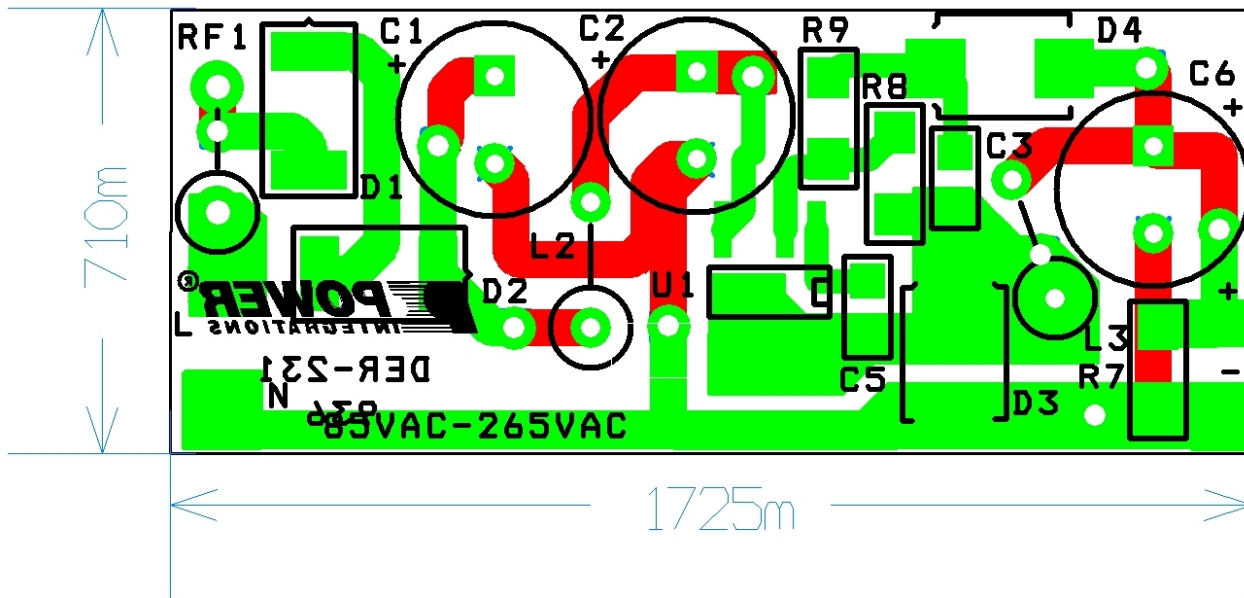

Figure 3 – Printed Circuit Board.

6 Bill of Materials

Item	QTY	Ref Des	Description	Mfg Part Number	Manufacturer
1	1	C1	2.2 μ F, 400 V, Electrolytic, (8 x 11.5)	SMG400VB2R2M8X11LL	Nippon Chemi-Con
2	1	C2	4.7 μ F, 400 V, Electrolytic, (8 x 11.5)	TAQ2G4R7MK0811MLL3	Taicon Corporation
3	1	C3	1 μ F, 25 V, Ceramic, X7R, 0805	ECJ-2FB1E105K	Panasonic
4	1	C5	100 nF, 50 V, Ceramic, X7R, 0805	ECJ-2YB1H104K	Panasonic
5	1	C6	100 μ F, 16 V, Electrolytic, Low ESR, 250 m Ω , (6.3 x 11.5)	ELXZ160ELL101MFB5D	Nippon Chemi-Con
6	1	D2	1000 V, 1 A, Rectifier, Glass Passivated, DO-213AA	DL4007	Diodes Inc
7	2	D3 D4	1000 V, 1 A, Ultrafast Recovery, 75 ns, DO-41	UF4007-E3	Vishay
8	1	L2	1 mH, 0.15 A, Ferrite Core	SBCP-47HY102B	Tokin
9	1	L3	1 mH, 0.30 A, Ferrite Core	CTCH895F-102K	CTParts
10	1	R7	3.9 k Ω , 5%, 1/8 W, Metal Film, 0805	ERJ-6GEYJ392V	Panasonic
11	1	R8	2 k Ω , 1%, 1/4 W, Metal Film, 1206	ERJ-8ENF2001V	Panasonic
12	1	R9	11.8 k Ω , 1%, 1/4 W, Metal Film, 1206	ERJ-8ENF1182V	Panasonic
13	1	RF1	10 Ω , 2 W, Fusible/Flame Proof Wire Wound	CRF253-4 10R	Vitrohm
14	1	U1	LinkSwitch-TN, LNK304DG, SO-8	LNK304DG	Power Integrations



7 Transformer Design Spreadsheet

ACDC_LinkSwitch-TN_041607; Rev.2.6; Copyright Power Integrations 2007	INPUT	INFO	OUTPUT	UNIT	LinkSwitch-TN_Rev_2-6.xls: LinkSwitch-TN Design Spreadsheet
INPUT VARIABLES					
VACMIN	85			Volts	Minimum AC Input Voltage
VACMAX	265			Volts	Maximum AC Input Voltage
FL	50			Hertz	Line Frequency
VO	12.00			Volts	Output Voltage
IO	0.110			Amps	Output Current
EFFICIENCY (User Estimate)	0.72				Overall Efficiency Estimate (Adjust to match Calculated, or enter Measured Efficiency)
EFFICIENCY (Calculated Estimate)			0.74		Calculated % Efficiency Estimate
CIN	6.90		6.90	uF	Input Filter Capacitor
Input Stage Resistance			0.00	ohms	Input Stage Resistance, Fuse & Filtering
Ambient Temperature			50	deg C	Operating Ambient Temperature (deg Celsius)
Switching Topology			Buck		Type of Switching topology
Input Rectification Type	H		H		Choose H for Half Wave Rectifier and F for Full Wave Rectification
DC INPUT VARIABLES					
VMIN			73.6	Volts	Minimum DC Bus Voltage
VMAX			374.8	Volts	Maximum DC Bus Voltage
LinkSwitch-TN					
LinkSwitch-TN	Auto		LNK304		Selected LinkSwitch-TN. Ordering info - Suffix P/G indicates DIP 8 package; suffix D indicates SO8 package; second suffix N indicates lead free RoHS compliance
ILIMIT			0.257	Amps	Typical Current Limit
ILIMIT_MIN			0.240	Amps	Minimum Current Limit
ILIMIT_MAX			0.275	Amps	Maximum Current Limit
FSMIN			62000	Hertz	Minimum Switching Frequency
VDS			11.4	Volts	Maximum On-State Drain To Source Voltage drop
PLOSS_LNK			0.33	Watts	Estimated LinkSwitch-TN losses
DIODE					
VD			0.70	Volts	Freewheeling Diode Forward Voltage Drop
VRR			600	Volts	Recommended PIV rating of Freewheeling Diode
IF			1	Amps	Recommended Diode Continuous Current Rating
TRR			75	ns	Recommended Reverse Recovery Time
Diode Recommendation			UF4005		Suggested Freewheeling Diode
OUTPUT INDUCTOR					
L_TYP			831.9	uH	Required value of Inductance to deliver Output Power (Includes device and inductor tolerances) Choose next higher standard available value
L			1000	uH	Output Inductor, Recommended Standard Value
L_R			2.0	Ohms	DC Resistance of Inductor
OPERATING MODE					
KL_TOL			1.15		Mostly Discontinuous Conduction Mode (at VMIN) Inductor tolerance Factor. Accounts for basic (10% - 20%) Manufacturing Tolerances $1.1 < KL_TOL < 1.2$ See AN-37 for detailed explanation
K_LOSS			0.813		Loss factor. Accounts for "off-state" power loss to be supplied by inductor Calculated efficiency $< K_LOSS < 1$. See AN-37 for detailed explanation
ILRMS			0.13	Amps	Estimated RMS inductor current (at VMAX)
OUTPUT CAPACITOR					
DELTA_V			0.12	Volts	Target Output Voltage Ripple
MAX_ESR			500	m-Ohms	Maximum Capacitor ESR (milli-ohms)
I RIPPLE			0.24	Amps	Output Capacitor Ripple current



FEEDBACK COMPONENTS					
RBIAS			2.00	k-Ohms	Bias Resistor. Use closest standard 1% value
RFB			11.86	k-Ohms	Feedback Resistor. Use closest standard 1% value
CFB			10	uF	Feedback Capacitor
C_SOFT_START			1 - 10	uF	If the output Voltage is greater than 12 V, or total output and system capacitance is greater than 100 uF, a soft start capacitor between 1uF and 10 uF is recommended. See AN-37 for details



8 Performance Data

8.1 Zero Load Input Power

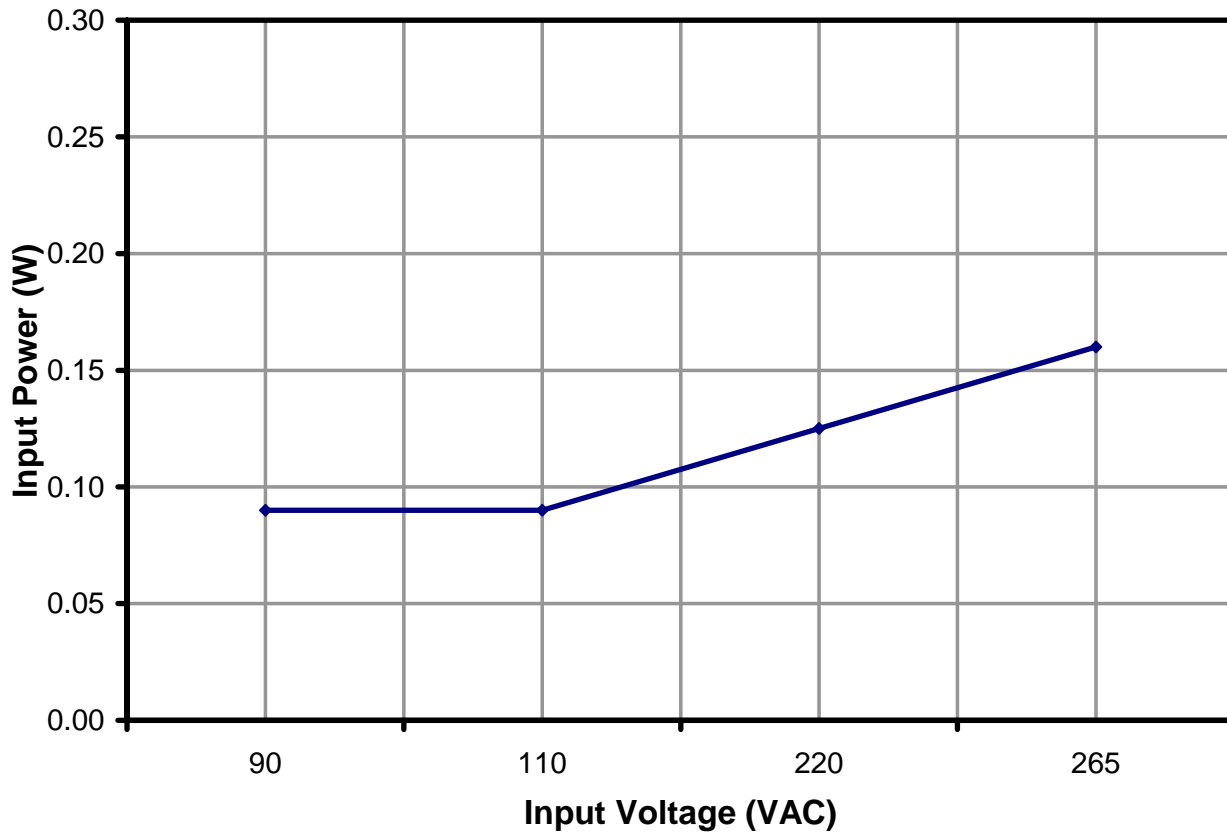

Figure 4 – Minimum Load Input Power vs. Input Voltage.



8.2 Efficiency

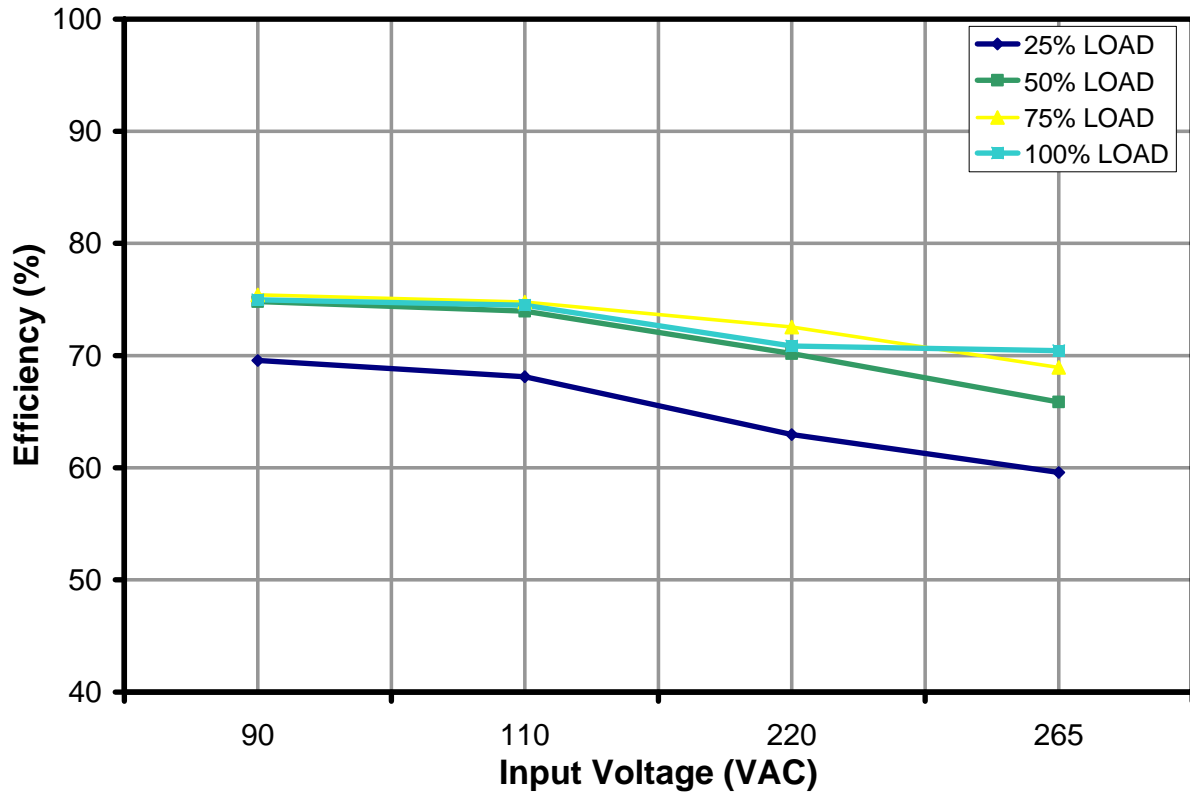

Figure 5 – Efficiency vs. Input Voltage and Output Load.

Percent of Full Load	Efficiency (%)	
	110 VAC	220 VAC
25	68.17	62.96
50	73.95	70.18
75	74.78	72.54
100	74.49	70.86
Average	72.85	69.14
US EISA (2007) requirement	52	
ENERGY STAR EPS v2, EC CoC v4, EUP Tier 2	64	



8.3 Regulation

8.3.1 Output Load and Line Regulation

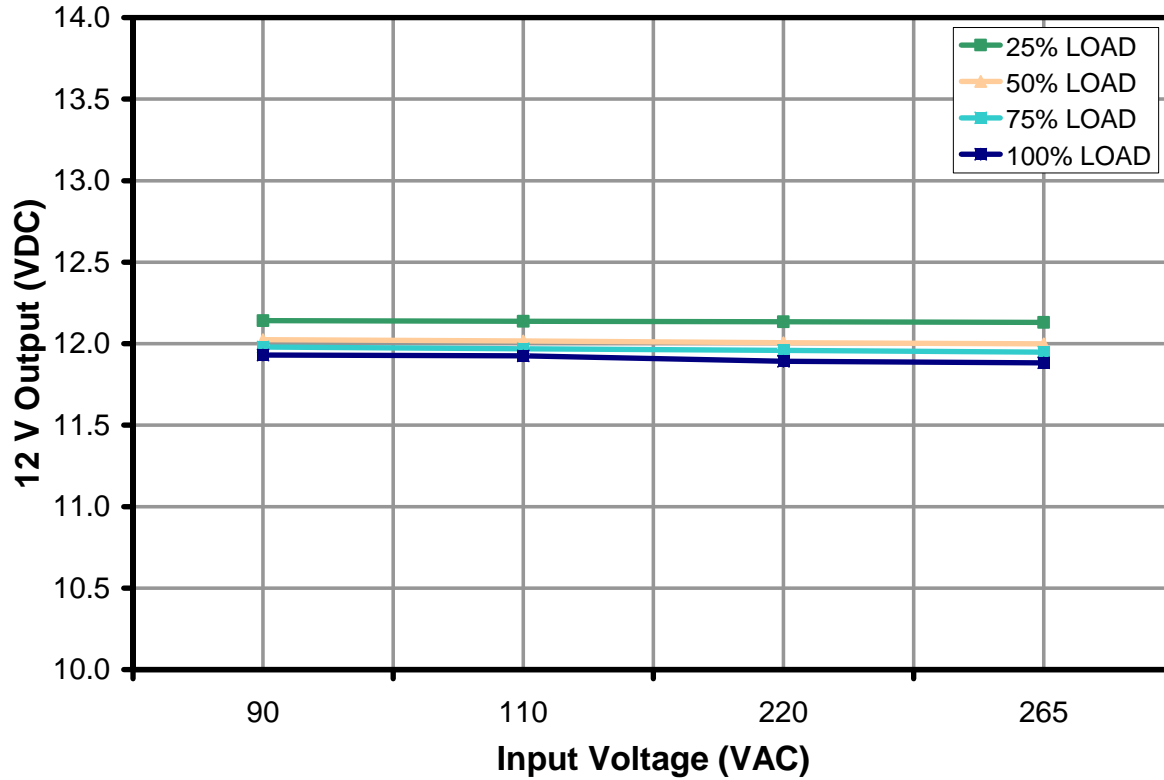

Figure 6 – Output Regulation vs. Input Voltage and Output Load.



9 Thermal Performance

Measurements have been performed in open frame conditions with an ambient temperature of 25 °C, an input voltage of 90 and 265 VAC and in full load condition. Warm up time was 60 minutes.

ITEM	90 VAC	265 VAC
	°C	°C
Ambient	24	24
U1	48	55.8



10 Waveforms

10.1 Drain Voltage and Inductor Current, Normal Operation, No-load

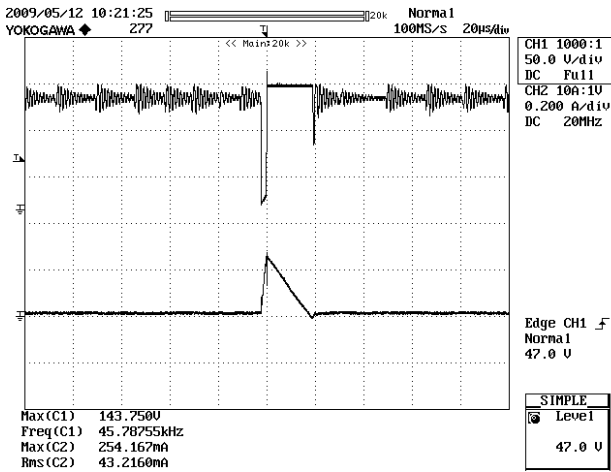

Figure 7 – 90 VAC, No-load.
Lower: I_{L3} , 0.2 A / div.
Upper: V_{DRAIN} , 50 V, 20 μ s / div.

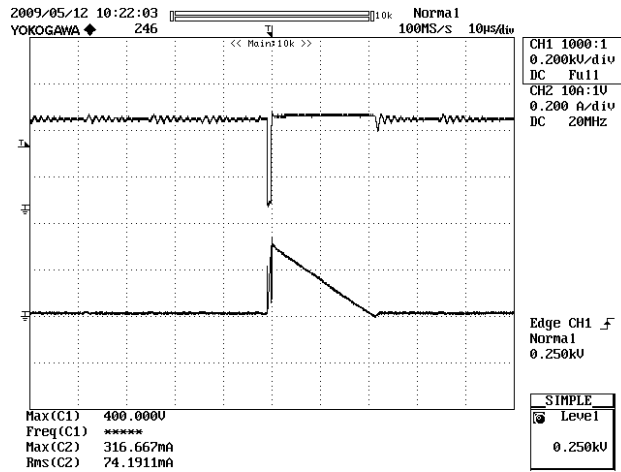

Figure 8 – 265 VAC, No-load.
Lower: I_{L3} , 0.2 A / div.
Upper: V_{DRAIN} , 200 V, 10 μ s / div.

10.2 Drain Voltage and Inductor Current, Normal Operation

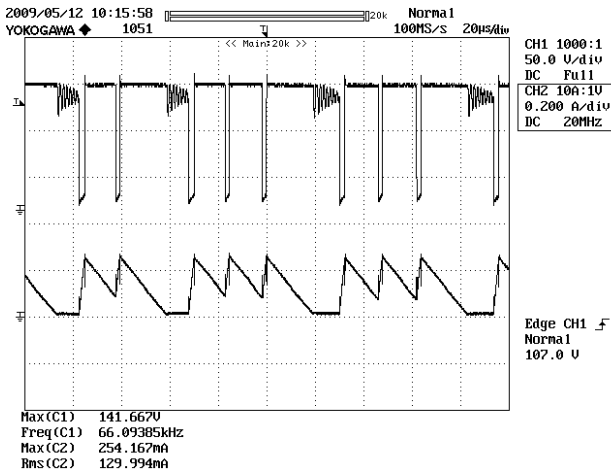

Figure 9 – 90 VAC, Full Load.
Lower: I_{L3} , 0.2 A / div.
Upper: V_{DRAIN} , 50 V, 20 μ s / div.

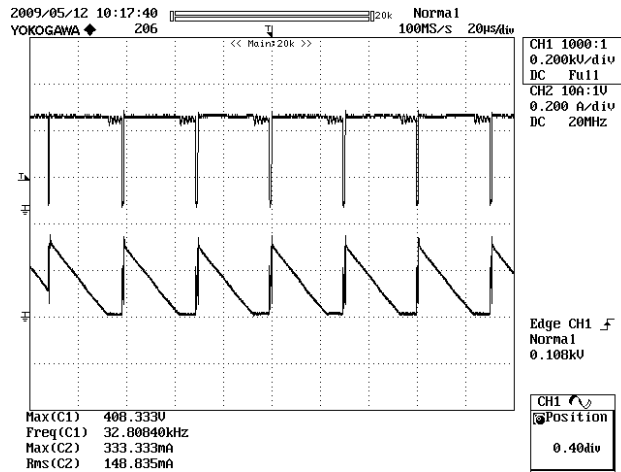

Figure 10 – 265 VAC, Full Load.
Lower: I_{L3} , 0.2 A / div.
Upper: V_{DRAIN} , 200 V, 20 μ s / div.



10.3 Output Voltage Start-up Profile

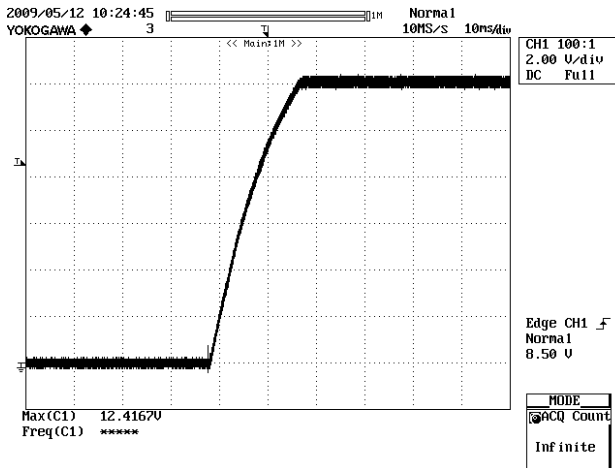

Figure 11 – Start-up Profile, 90 VAC.
Full Load. V_{OUT} , 2 V, 10 ms / div.

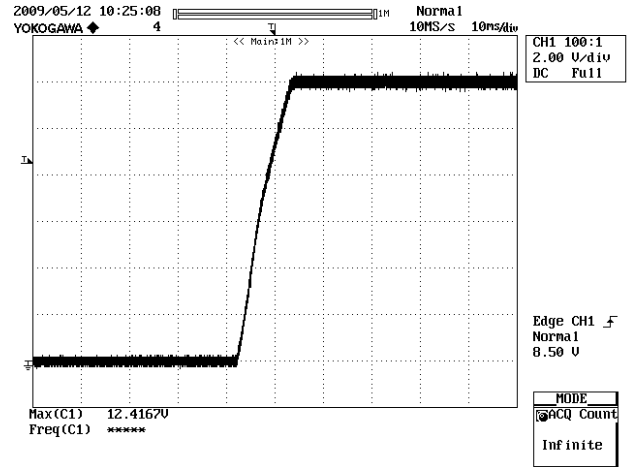

Figure 12 – Start-up Profile, 265 VAC.
Full Load. V_{OUT} , 2 V, 10 ms / div.

10.4 Drain Voltage and Inductor Current Start-up Profile

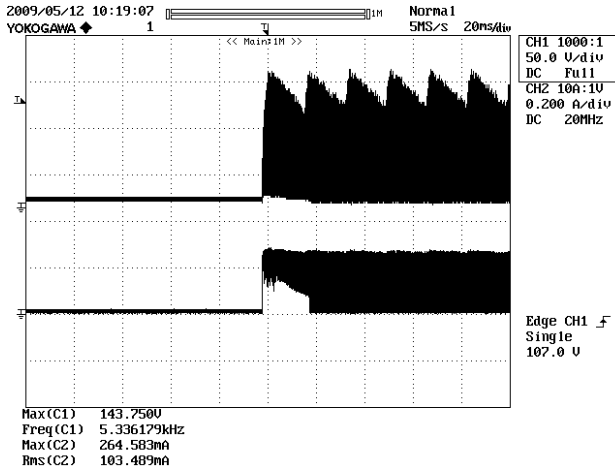

Figure 13 – 90 VAC, Full Load.
Lower: I_{L3} , 0.2 A / div.
Upper: V_{DRAIN} , 50 V, 20 ms / div.

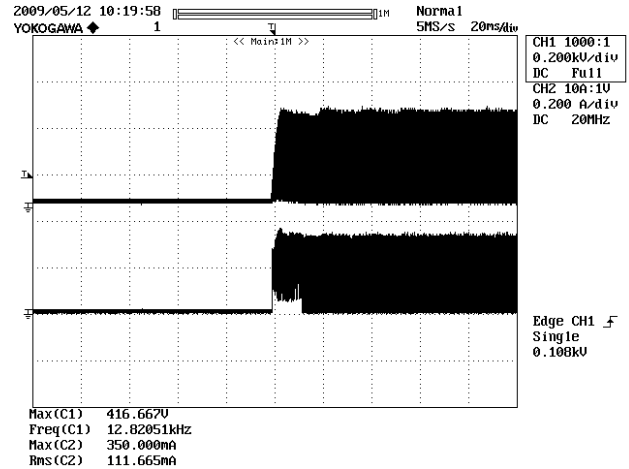

Figure 14 – 265 VAC, Full Load.
Lower: I_{L3} , 0.2 A / div.
Upper: V_{DRAIN} , 200 V, 20 ms / div.



10.5 Output Ripple Measurements

10.5.1 Ripple Measurement Technique

For DC output ripple measurements, a modified oscilloscope test probe must be utilized in order to reduce spurious signals due to pickup. Details of the probe modification are provided in the figures below.

The 5125BA probe adapter is affixed with two capacitors tied in parallel across the probe tip. The capacitors include one (1) 0.1 μF /100 V ceramic type and one (1) 1.0 μF /100 V aluminum electrolytic. **The aluminum electrolytic type capacitor is polarized, so proper polarity across DC outputs must be maintained (see below).**

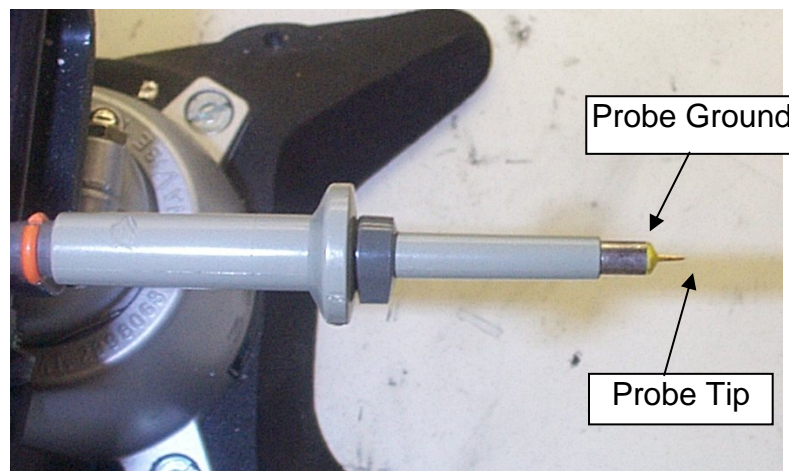

Figure 15 – Oscilloscope Probe Prepared for Ripple Measurement. (End Cap and Ground Lead Removed).



Figure 16 – Oscilloscope Probe with Probe Master 5125BA BNC Adapter. (Modified with wires for probe ground for ripple measurement, and two parallel decoupling capacitors added).

Measurement Results

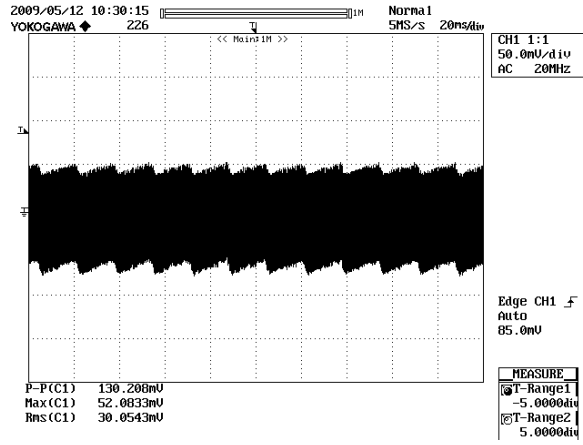

Figure 17 – Output Ripple, 90 VAC, Full Load.
V_{OUT}, 50 mV, 20 ms / div.

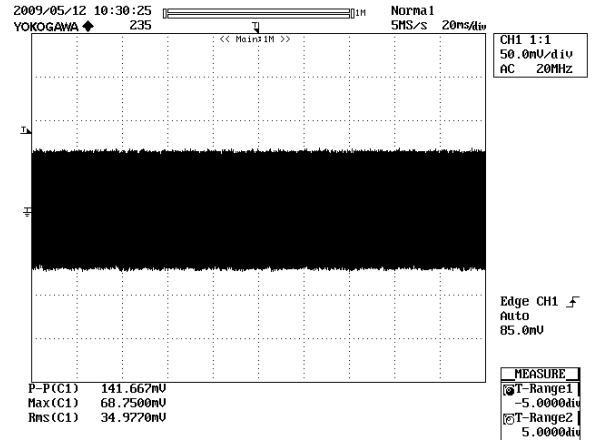

Figure 18 – Output Ripple, 265 VAC, Full Load.
V_{OUT}, 50 mV, 20 ms / div.



11 Conducted EMI Measurements

EMI measurements made using **ROHDE & SCHWARZ** ESPI – Test Receiver Model No 1164.6407.03 and LISN ENV216 Model No 3560.6550.06. EMI scan was measured with output return connected to the Artificial Hand terminal on LISN.

11.1 Input 115 VAC Full Load

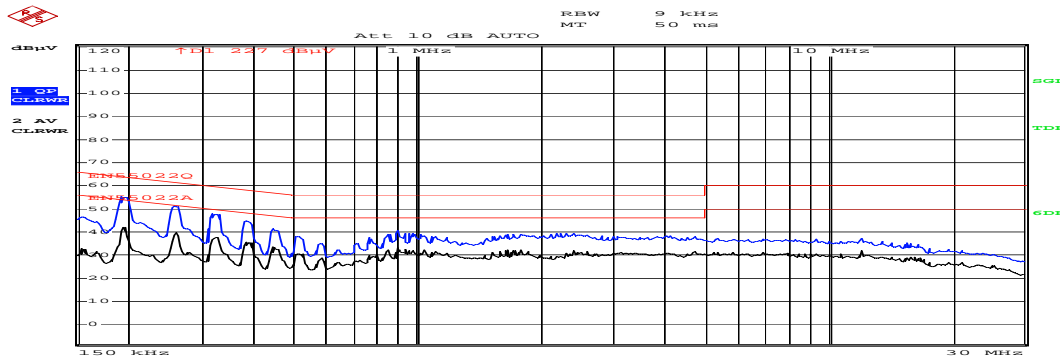

Figure 19 – Conducted EMI 115 VAC Line, EN 55022 B Limits, EN 55022 Q: QP Limit: EN 55022 A: Average Limit: Blue: PK Scan, Black: Average Scan.

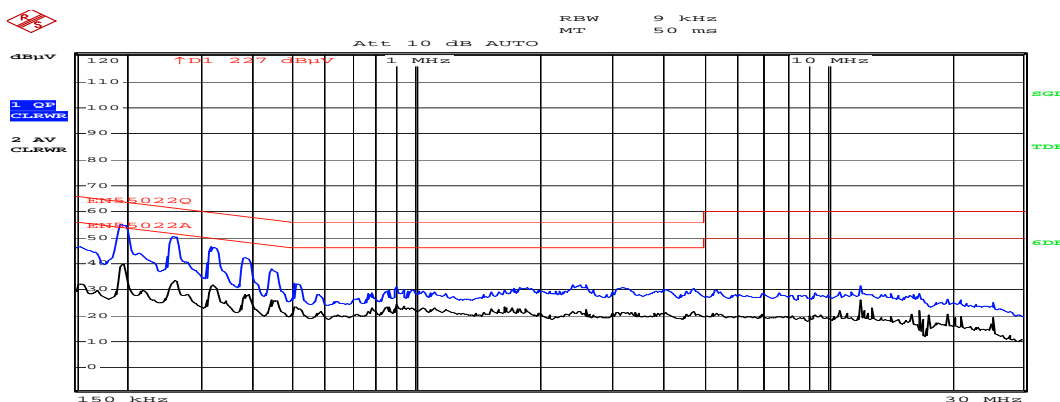

Figure 20 – Conducted EMI 115 VAC Neutral, EN 55022 B Limits, EN 55022 Q: QP Limit: EN 55022 A: Average Limit: Blue: PK Scan, Black: Average Scan.



11.2 Input 230 VAC Full Load

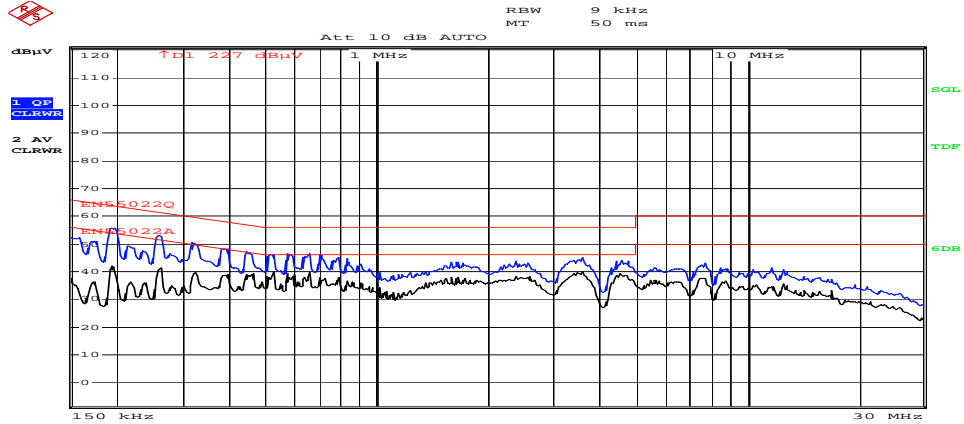

Figure 21 – Conducted EMI 230 VAC Line, EN 55022 B Limits, EN 55022 Q: QP Limit EN 55022 A: Average Limit: Blue: PK Scan, Black: Average Scan.

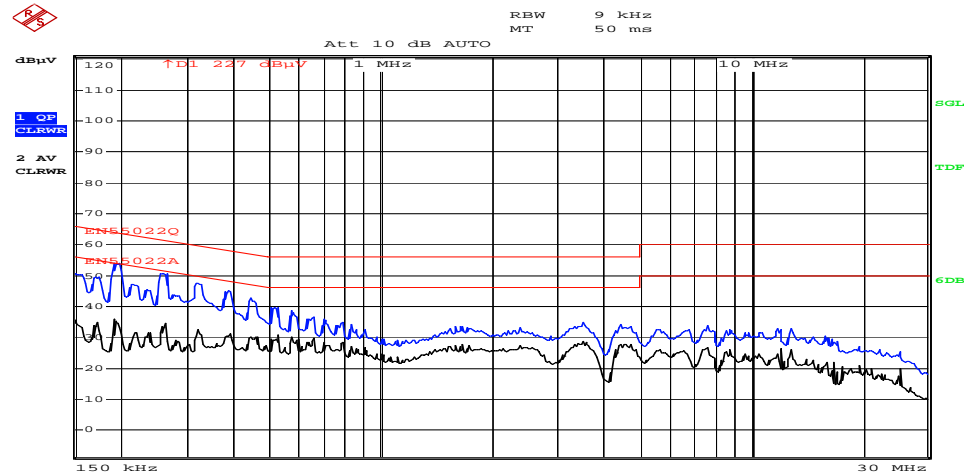

Figure 22 – Conducted EMI 230 VAC Neutral, EN 55022 B Limits, EN 55022 Q: QP Limit EN55022A: Average Limit: Blue: PK Scan, Black: Average Scan



12 Revision History

Date	Author	Revision	Description & Changes	Reviewed
24-Sep-09	BM	1.0	Initial Release	Apps & Mktg



For the latest updates, visit our website: www.powerint.com

Power Integrations reserves the right to make changes to its products at any time to improve reliability or manufacturability. Power Integrations does not assume any liability arising from the use of any device or circuit described herein. POWER INTEGRATIONS MAKES NO WARRANTY HEREIN AND SPECIFICALLY DISCLAIMS ALL WARRANTIES INCLUDING, WITHOUT LIMITATION, THE IMPLIED WARRANTIES OF MERCHANTABILITY, FITNESS FOR A PARTICULAR PURPOSE, AND NON-INFRINGEMENT OF THIRD PARTY RIGHTS.

PATENT INFORMATION

The products and applications illustrated herein (including transformer construction and circuits external to the products) may be covered by one or more U.S. and foreign patents, or potentially by pending U.S. and foreign patent applications assigned to Power Integrations. A complete list of Power Integrations' patents may be found at www.powerint.com. Power Integrations grants its customers a license under certain patent rights as set forth at <http://www.powerint.com/ip.htm>.

The PI Logo, TOPSwitch, TinySwitch, LinkSwitch, DPA-Switch, PeakSwitch, EcoSmart, Clampless, E-Shield, Filterfuse, StackFET, PI Expert and PI FACTS are trademarks of Power Integrations, Inc. Other trademarks are property of their respective companies. ©Copyright 2009 Power Integrations, Inc.

Power Integrations Worldwide Sales Support Locations

WORLD HEADQUARTERS

5245 Hellyer Avenue
San Jose, CA 95138, USA.
Main: +1-408-414-9200
Customer Service:
Phone: +1-408-414-9665
Fax: +1-408-414-9765
e-mail: usasales@powerint.com

GERMANY

Rueckertstrasse 3
D-80336, Munich
Germany
Phone: +49-89-5527-3911
Fax: +49-89-5527-3920
e-mail: eurosales@powerint.com

JAPAN

Kosei Dai-3 Bldg.,
2-12-11, Shin-Yokohama,
Kohoku-ku, Yokohama-shi,
Kanagawa 222-0033
Phone: +81-45-471-1021
Fax: +81-45-471-3717
e-mail: japansales@powerint.com

TAIWAN

5F, No. 318, Nei Hu Rd., Sec. 1
Nei Hu Dist.
Taipei, Taiwan 114, R.O.C.
Phone: +886-2-2659-4570
Fax: +886-2-2659-4550
e-mail: taiwansales@powerint.com

CHINA (SHANGHAI)

Rm 1601/1610, Tower 1,
Kerry Everbright City
No. 218 Tianmu Road West,
Shanghai, P.R.C. 200070
Phone: +86-21-6354-6323
Fax: +86-21-6354-6325
e-mail: chinasales@powerint.com

INDIA

#1, 14th Main Road
Vasanthanagar
Bangalore-560052 India
Phone: +91-80-41138020
Fax: +91-80-41138023
e-mail: indiasales@powerint.com

KOREA

RM 602, 6FL
Korea City Air Terminal B/D,
159-6
Samsung-Dong, Kangnam-
Gu,
Seoul, 135-728, Korea
Phone: +82-2-2016-6610
Fax: +82-2-2016-6630
e-mail: koreasales@powerint.com

UNITED KINGDOM

1st Floor, St. James's House
East Street, Farnham
Surrey, GU9 7TJ
United Kingdom
Phone: +44 (0) 1252-730-141
Fax: +44 (0) 1252-727-689
e-mail: eurosales@powerint.com

CHINA (SHENZHEN)

Rm A, B & C 4th Floor, Block C,
Electronics Science and
Technology Building, 2070
Shennan Zhong Rd,
Shenzhen, Guangdong,
China, 518031
Phone: +86-755-8379-3243
Fax: +86-755-8379-5828
e-mail: chinasales@powerint.com

ITALY

Via De Amicis 2
20091 Bresso MI – Italy
Phone: +39-028-928-6000
Fax: +39-028-928-6009
e-mail: eurosales@powerint.com

SINGAPORE

51 Newton Road,
#15-08/10 Goldhill Plaza,
Singapore, 308900
Phone: +65-6358-2160
Fax: +65-6358-2015
e-mail: singaporesales@powerint.com

APPLICATIONS HOTLINE

World Wide +1-408-414-9660

APPLICATIONS FAX

World Wide +1-408-414-9760

