



Design Example Report

Title	<i>19.3 W Wide Range Flyback Power Supply Using TOPSwitch™-GX TOP243Y</i>
Specification	207 VAC – 400 VAC Input; 14 V / 1.2 A and 5 V / 0.5 A Outputs
Application	Oven Control
Author	Applications Engineering Department
Document Number	DER-105
Date	July 23, 2012
Revision	1.1

Summary and Features

- StackFET™ flyback topology delivers full load over extremely wide input AC voltage range
- Very good cross regulation without using linear regulators
- 132 kHz switching frequency with jitter to reduce conducted EMI
- Auto-restart function for automatic and self-resetting open-loop, overload and short-circuit protection
- Built-in hysteretic thermal shutdown at 135 °C
- EcoSmart™ for extremely low standby power consumption <500 mW at 265 VAC

The products and applications illustrated herein (including circuits external to the products and transformer construction) may be covered by one or more U.S. and foreign patents or potentially by pending U.S. and foreign patent applications assigned to Power Integrations. A complete list of Power Integrations' patents may be found at www.powerint.com.

Table of Contents

1	Introduction.....	3
2	Power Supply Specification	4
3	Schematic.....	5
4	Circuit Description	6
4.1	Input EMI Filtering	6
4.2	TOPSwitch Primary	6
4.3	Output Rectification	6
4.4	Output Feedback.....	6
5	PCB Layout	7
6	Bill of Materials	8
7	Transformer Specification.....	9
7.1	Electrical Diagram	9
7.2	Electrical Specifications.....	9
7.3	Materials.....	9
7.4	Transformer Build Diagram	10
7.5	Transformer Construction.....	10
8	Transformer Design Spreadsheet.....	11
9	Performance Data	14
9.1	Efficiency.....	14
9.2	No-load Input Power.....	14
9.3	Regulation	15
9.3.1	Load	15
9.3.2	Line	15
10	Thermal Performance	16
11	Waveforms.....	17
11.1	Drain Voltage and Current, Normal Operation.....	17
11.2	Output Voltage Start-up Profile.....	17
11.3	Drain Voltage and Current Start-up Profile	18
11.4	Load Transient Response (75% to 100% Load Step)	19
11.5	Output Ripple Measurements.....	20
11.5.1	Ripple Measurement Technique	20
11.5.2	Measurement Results	21
12	Conducted EMI	22
13	Revision History.....	23

Important Notes:

Although this board is designed to satisfy safety isolation requirements, the engineering prototype has not been agency approved. Therefore, all testing should be performed using an isolated source to provide power to the prototype board.

Design Reports contain a power supply design specification, schematic, bill of materials, and transformer documentation. Performance data and typical operation characteristics are included. Typically only a single prototype has been built.



1 Introduction

This document is an engineering report describing a wide-range non-isolated StackFET™ flyback converter using TOPSwitch-GX TOP243Y.

The document contains the power supply specification, schematic, bill-of-materials, transformer documentation, printed circuit layout, and performance data.

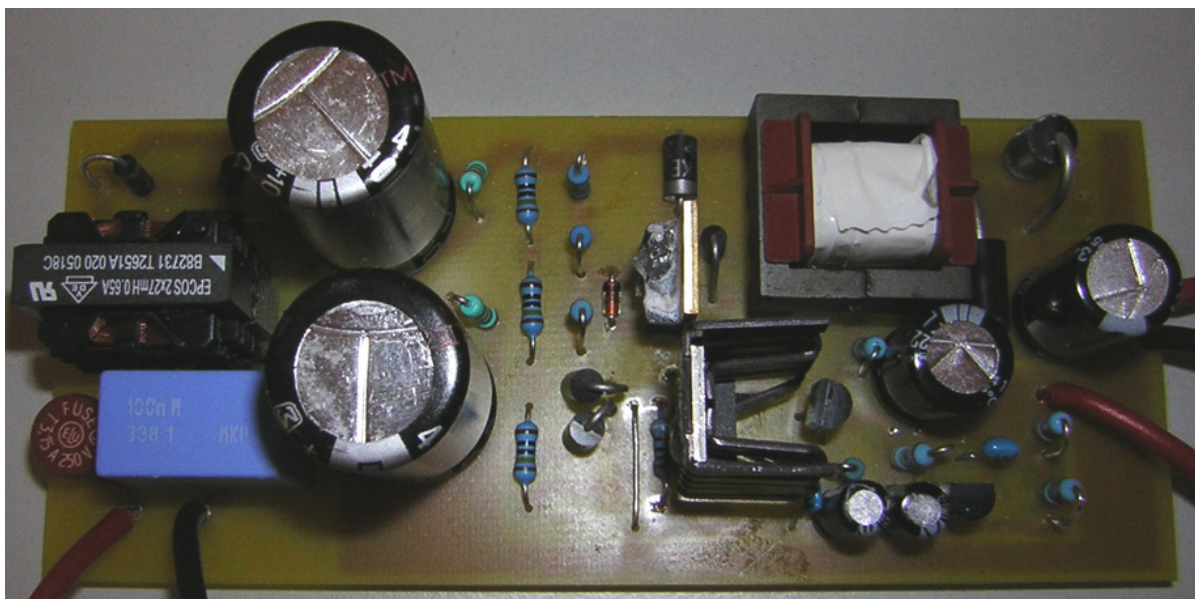

Figure 1 – Populated Circuit Board Photograph.

2 Power Supply Specification

Description	Symbol	Min	Typ	Max	Units	Comment
Input						
Voltage	V_{IN}	207		400	VAC	2 Wire – no P.E.
Frequency	f_{LINE}	47	50/60	64	Hz	
No-load Input Power (230 VAC)				0.3	W	
Output						
Output Voltage 1	V_{OUT1}	12.6	14	15.4	V	±10% 20 MHz bandwidth
Output Ripple Voltage 1	$V_{RIPPLE1}$				mV	
Output Current 1	I_{OUT1}		1.2		A	±5% 20 MHz bandwidth
Output Voltage 2	V_{OUT2}	4.75	5	5.25	V	
Output Ripple Voltage 2	$V_{RIPPLE2}$				mV	
Output Current 2	I_{OUT2}		0.5		A	
Total Output Power						
Continuous Output Power	P_{OUT}			19.3	W	
Peak Output Power	P_{OUT_PEAK}			19.3	W	
Efficiency	η	79			%	Measured at P_{OUT} (19.3 W), 25 °C
Environmental						
Conducted EMI			Meets CISPR22B / EN55022B			1.2/50 μ s surge, IEC 1000-4-5, Series Impedance: Differential Mode: 2 Ω Common Mode: 12 Ω
Safety			Designed to meet IEC950, UL1950 Class II			
Surge		4			kV	
Surge		3			kV	100 kHz ring wave, 500 A short circuit current, differential and common mode
Ambient Temperature	T_{AMB}	0		85	°C	Free convection, sea level



3 Schematic

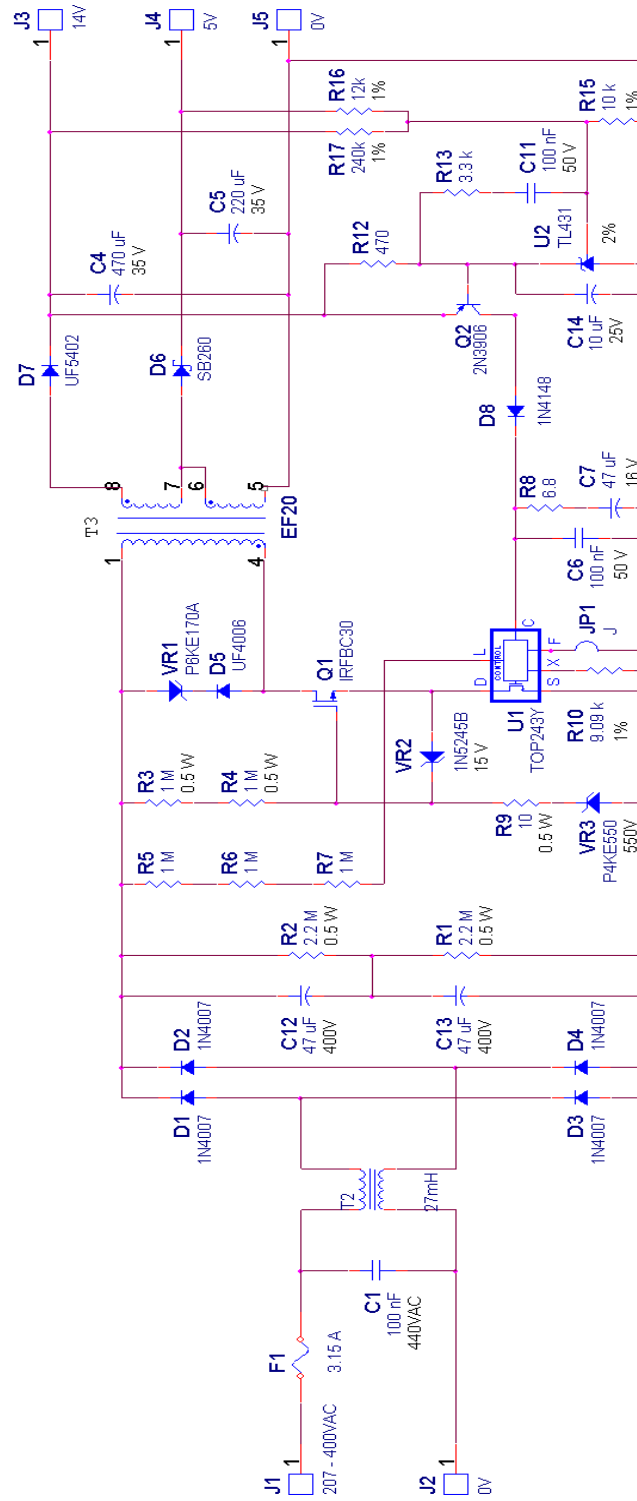

Figure 2 – Schematic.



4 Circuit Description

4.1 Input EMI Filtering

AC input power is rectified and filtered by D1-D4 to produce a DC voltage across the series stacked high-voltage electrolytic capacitors C12 and C13. R1 and R2 help maintain voltage equalization across the series connected capacitors.

4.2 TOPSwitch Primary

The rectified high-voltage DC is applied to the transformer T3 primary winding. The other end of the primary winding is connected to a high-voltage MOSFET (Q1) that is cascade connected to the Drain of TOPSwitch-GX (U1). This configuration is called StackFET.

Zener diode VR3 clamps the maximum Drain-Source voltage across TOPSwitch-GX to less than 600 V. Zener diode VR2 ensures that the maximum Gate-Source voltage of Q1 does not exceed 15 V. Resistor R3 and R4 provide bias to enhance the gate of Q1 when its Source is switched low by the Drain of U1.

Zener diode VR1 and D5 clamp the leakage inductance spike to limit the effective voltage across Q1 and U1 to about 740 V peak at 400 VAC input. It is recommended that the maximum voltage (V_{DS}) across U1 is maintained to below 80% of the BV_{DSS} rating of the device.

There is no bias winding necessary, because of the non-isolated topology the bias voltage is taken from the 14 V output from the secondary side.

4.3 Output Rectification

Diode D6 and D7 along with capacitors C4 and C5 are used to rectify and filter the two output secondary windings of T3.

4.4 Output Feedback

A voltage divider consisting of resistors R17, R16 and R15 monitors the voltage on the 14 V and 5 V outputs. The resistor values are weighted so that the voltage feedback loop is controlled mostly by the 5 V output, with some contribution from the 14 V output. Sharing the voltage regulation control between the two outputs in this manner improves the cross regulation for the 14 V output at the expense of a slight change in the regulation of the 5 V output.

The voltage from R17, R16 and R15 is applied to the reference pin of the shunt regulator of U3. These resistor values and the reference voltage of U2 are used to set the output voltages of the supply. The optocoupler usually used for isolation in the feedback circuit is replaced by a simple PNP Transistor Q2, which provides the feedback current to TOPSwitch-GX. Note: If gain needs to be reduced, insert a $\sim 220 \Omega$ resistor in series with Q2's emitter.



5 PCB Layout

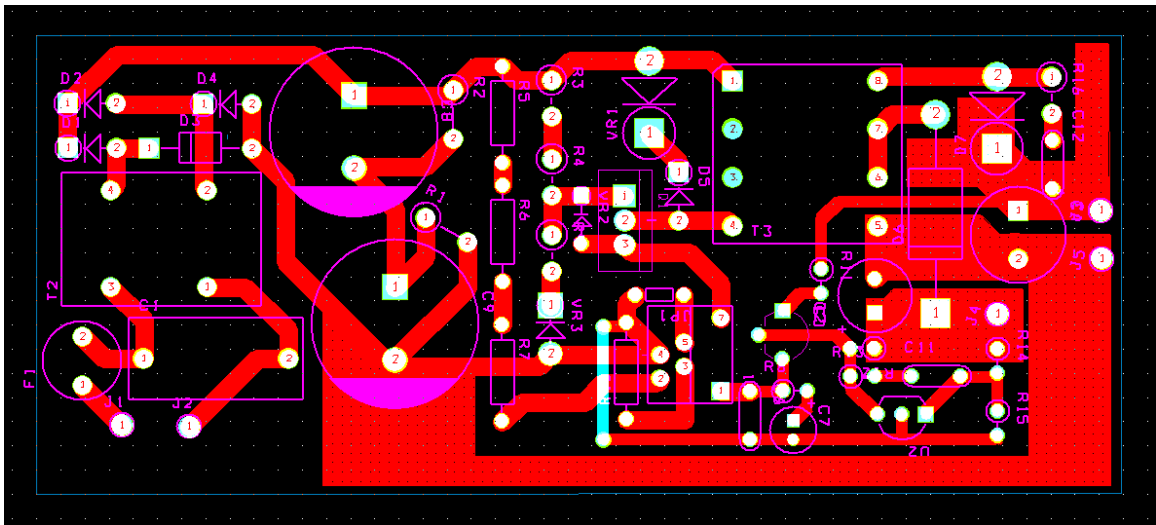

Figure 3 – Printed Circuit Layout.



6 Bill of Materials

Item	Qty	Ref Des	Description	Mfg Part Number	Mfg
1	1	C1	100 nF, 440 VAC, Film, X2	2222 338 10104	Vishay
2	1	C4	470 μ F, 35 V, Electrolytic, Low ESR, 52 m Ω , (10 x 20)	LXZ35VB471MJ20LL	United Chemi-Con
3	1	C5	220 μ F, 35 V, Electrolytic, Low ESR, 90 m Ω , (8 x 15)	LXZ35VB221MH15LL	United Chemi-Con
4	2	C6 C11	100 nF, 50 V, Ceramic, X7R	ECU-S1H104KBB	Panasonic
5	1	C7	47 μ F, 16 V, Electrolytic, Gen. Purpose, (5 x 11)	KME16VB47RM5X11LL	United Chemi-Con
6	2	C12 C13	47 μ F, 400 V, Electrolytic, High Ripple, 105 $^{\circ}$ C		Panasonic
7	1	C14	10 μ F, 25 V, Electrolytic, Gen. Purpose		Panasonic
8	4	D1 D2 D3 D4	1000 V, 1 A, Rectifier, DO-41	1N4007	Vishay
9	1	D5	600 V, 1 A, Ultrafast Recovery, 75 ns, DO-41	UF4006	Vishay
10	1	D6	60 V, 2 A, Schottky, DO-204AC	SB260	Vishay
11	1	D7	200 V, 3 A, Ultrafast Recovery, 50 ns, DO-201AD	UF5402	Vishay
12	1	D8	75 V, 300 mA, Fast Switching, DO-35	1N4148	Vishay
13	1	F1	3.15 A, 250 V, Fast, TR5	3,701,315,041	Wickman
14	1	JP1	Wire Jumper, Non insulated, 22 AWG, 0.3 in	298	Alpha
15	1	Q1	600 V, 3.6 A, 2.2 Ω , N-Channel, TO-220AB	IRFBC30	International Rectifier
16	1	Q2	PNP, Small Signal BJT, 40 V, 0.2 A, TO-92	2N3906	Fairchild
17	2	R1 R2	2.2 M Ω , 5%, 1/2 W, Carbon Film	CFR-50JB-2M2	Yageo
18	2	R3 R4	1 M Ω , 5%, 1/2 W, Carbon Film	CFR-50JB-1M0	Yageo
19	3	R5 R6 R7	1 M Ω , 5%, 1/4 W, Carbon Film	CFR-25JB-1M0	Yageo
20	1	R8	6.8 Ω , 5%, 1/4 W, Carbon Film	CFR-25JB-6R8	Yageo
21	1	R9	10 Ω , 5%, 1/2 W, Carbon Film	CFR-50JB-10R	Yageo
22	1	R10	9.09 k Ω , 1%, 1/4 W, Metal Film	MFR-25FBF-9K09	Yageo
23	1	R12	470 Ω , 5%, 1/4 W, Carbon Film	CFR-25JB-470R	Yageo
24	1	R13	3.3 k Ω , 5%, 1/4 W, Carbon Film	CFR-25JB-3K3	Yageo
25	1	R15	10 k Ω , 1%, 1/4 W, Metal Film	MFR-25FBF-10K0	Yageo
26	1	R16	12 k Ω , 1%, 1/4 W, Metal Film	MFR-25FBF-12K	Yageo
27	1	R17	240 k Ω , 1%, 1/4 W, Metal Film	MFR-25FBF-240K	Yageo
28	1	T2	Common Mode Choke, 27 mH, 0.65 A	B82731T2651A020	Epcos
29	1	T3	Bobbin EF20, 8-Pin, Horizontal		Custom
30	1	U1	TOPSwitch-GX, TO220-7C	TOP243Y	Power Integrations
31	1	U2	2.495 V Shunt Regulator IC, 2%, 0 to 70C, TO-92	TL431CLP	Texas Instruments
32	1	VR1	170 V, 5 W, 5%, TVS, DO204AC (DO-15)	P6KE170A	Vishay
33	1	VR2	15 V, 5%, 500 mW, DO-35	1N5245B	Microsemi
34	1	VR3	200 V, 5 W, 5%, DO204AC (DO-15)	P4KE550A	Vishay
35	1	HS1			



7 Transformer Specification

7.1 Electrical Diagram

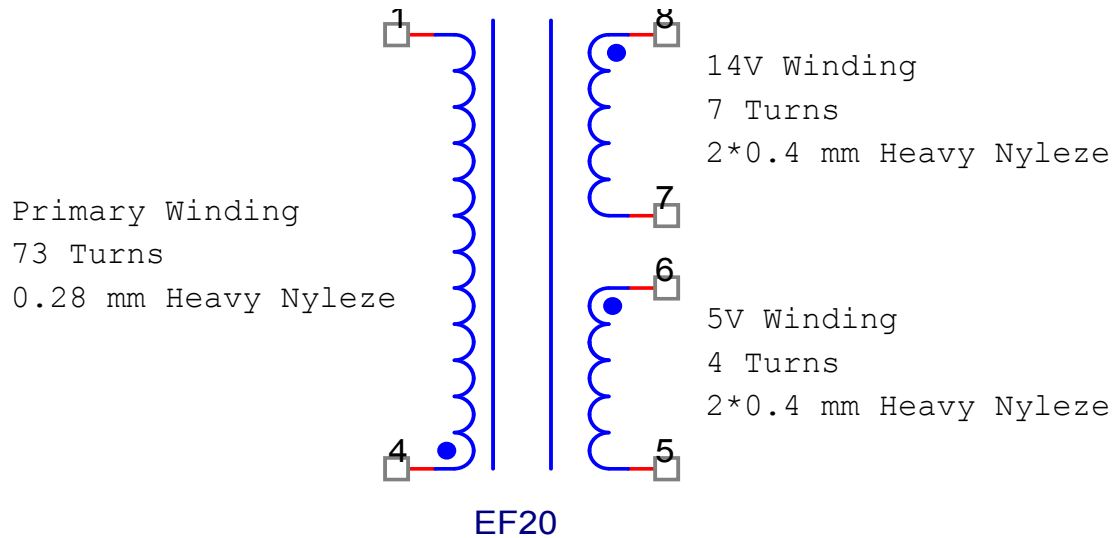

Figure 4 – Transformer Electrical Diagram

7.2 Electrical Specifications

Electrical Strength	1 second, 50 Hz, from pins 1-4 to pins 8-5 (pins 7/6 shorted).	3000 VAC
Primary Inductance	Pins 1-4, all other windings open, measured at 100 kHz, 0.4 V _{RMS} .	1 mH, -0/+20%
Primary Leakage Inductance	Pins 1-4, with Pins 8-5 shorted, measured at 100 kHz, 0.4 V _{RMS} .	50 μH (Max.)

7.3 Materials

Item	Description
[1]	Core: EF20, Epcos gapped for AL = 196 nH/T ² .
[2]	Bobbin: EF20 Horizontal, 8 pins.
[3]	Magnet Wire: 0.28 mm.
[4]	Magnet Wire: 0.4 mm.
[5]	Tape: 3M 1298 Polyester Film 12 mm.
[6]	Varnish.



7.4 Transformer Build Diagram

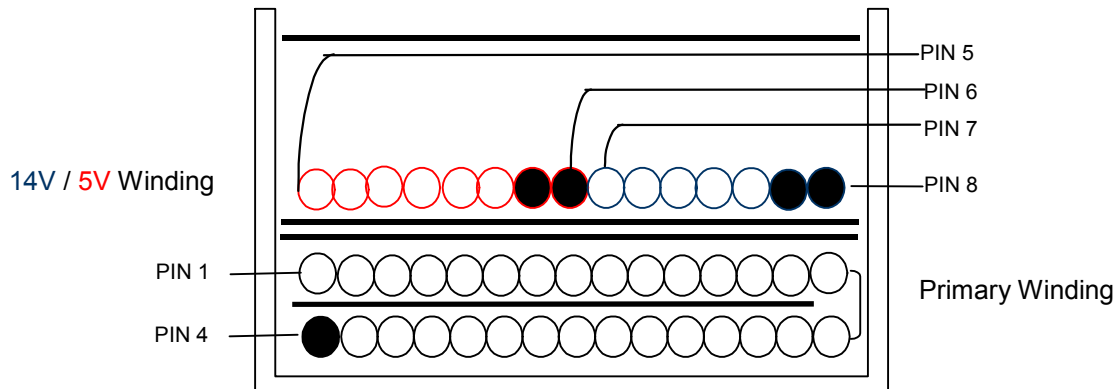

Figure 5 – Transformer Build Diagram.

7.5 Transformer Construction

Primary	Start at Pin 4. Wind 37 turns of item [3] in approximately 1 layer. Use one layer of item [5] for basic insulation. Wind remaining 36 primary turns, finish on pin 1.
Basic Insulation	Use two layers of item [5] for basic insulation.
Secondary Windings	Start at Pin 8. Wind 7 bifilar turns of item [4]. Finish on pin 7. Start at pin 6. Wind 4 bifilar turns of item [4] in the same layer. Finish on pin 5. Spread turns evenly across bobbin.
Outer Wrap	Wrap windings with 3 layers of tape [item [5]].
Final Assembly	Assemble and secure core halves so that the tape wrapped E core is at the bottom of the transformer. Varnish impregnate (item [6]).



8 Transformer Design Spreadsheet

	INPUT	INFO	OUTPUT	UNIT	
ENTER APPLICATION VARIABLES					
VACMIN	207			Volts	
VACMAX	400			Volts	Maximum AC Input Voltage
fL	50			Hertz	AC Mains Frequency
VO	5			Volts	Output Voltage (main)
PO	19.3			Watts	Output Power
η	0.7				Efficiency Estimate
Z	0.5				Loss Allocation Factor
VB	12			Volts	Bias Voltage
tC	3			mSeconds	Bridge Rectifier Conduction Time Estimate
CIN	23.5			uFarads	Input Filter Capacitor
ENTER TOPSWITCH-GX VARIABLES					
TOP-GX	top243			<i>Universal</i>	<i>115 Doubled/230V</i>
Chosen Device		TOP243	Power Out	30W	45W
KI	0.85				External Ilimit reduction factor (KI=1.0 for default ILIMIT, KI <1.0 for lower ILIMIT)
ILIMITMIN			0.689	Amps	Use 1% resistor in setting external ILIMIT
ILIMITMAX			0.842	Amps	Use 1% resistor in setting external ILIMIT
Frequency (F)=132kHz, (H)=66kHz	F				Full (F) frequency option - 132kHz
fS			132000	Hertz	TOPSwitch-GX Switching Frequency: Choose between 132 kHz and 66 kHz
fSmin			124000	Hertz	TOPSwitch-GX Minimum Switching Frequency
fSmax			140000	Hertz	TOPSwitch-GX Maximum Switching Frequency
VOR	100			Volts	Reflected Output Voltage
VDS	10			Volts	TOPSwitch on-state Drain to Source Voltage
VD	0.5			Volts	Output Winding Diode Forward Voltage Drop
VDB	0.7			Volts	Bias Winding Diode Forward Voltage Drop
KP	0.8				Ripple to Peak Current Ratio (0.4 < KRP < 1.0 : 1.0 < KDP < 6.0)
ENTER TRANSFORMER CORE/CONSTRUCTION VARIABLES					
Core Type	EF20				
Core		EF20		P/N:	PC40EF20-Z
Bobbin		EF20_BOBB IN		P/N:	*
AE			0.335	cm ²	Core Effective Cross Sectional Area
LE			4.49	cm	Core Effective Path Length
AL			1570	nH/T ²	Ungapped Core Effective Inductance
BW			12.2	mm	Bobbin Physical Winding Width
M	0			mm	Safety Margin Width (Half the Primary to Secondary Creepage Distance)
L	2				Number of Primary Layers
NS	4				Number of Secondary Turns
DC INPUT VOLTAGE PARAMETERS					
VMIN			263	Volts	Minimum DC Input Voltage
VMAX			566	Volts	Maximum DC Input Voltage
CURRENT WAVEFORM SHAPE PARAMETERS					
DMAX			0.28		Maximum Duty Cycle
I _{AVG}			0.10	Amps	Average Primary Current
I _P			0.62	Amps	Peak Primary Current
I _R			0.49	Amps	Primary Ripple Current
I _{RMS}			0.21	Amps	Primary RMS Current



TRANSFORMER PRIMARY DESIGN PARAMETERS					
LP			1035	uHenries	Primary Inductance
NP			73		Primary Winding Number of Turns
NB			9		Bias Winding Number of Turns
ALG			196	nH/T^2	Gapped Core Effective Inductance
BM			2621	Gauss	Maximum Flux Density at PO, VMIN (BM<3000)
BP			3576	Gauss	Peak Flux Density (BP<4200)
BAC			1048	Gauss	AC Flux Density for Core Loss Curves (0.5 X Peak to Peak)
ur			1675		Relative Permeability of Ungapped Core
LG			0.19	mm	Gap Length (Lg > 0.1 mm)
BWE			24.4	mm	Effective Bobbin Width
OD			0.34	mm	Maximum Primary Wire Diameter including insulation
INS			0.06	mm	Estimated Total Insulation Thickness (= 2 * film thickness)
DIA			0.28	mm	Bare conductor diameter
AWG			30	AWG	Primary Wire Gauge (Rounded to next smaller standard AWG value)
CM			102	Cmils	Bare conductor effective area in circular mils
CMA			482	Cmils/Amp	Primary Winding Current Capacity (200 < CMA < 500)
TRANSFORMER SECONDARY DESIGN PARAMETERS (SINGLE OUTPUT EQUIVALENT)					
Lumped parameters					
ISP			11.21	Amps	Peak Secondary Current
ISRMS			6.10	Amps	Secondary RMS Current
IO			3.86	Amps	Power Supply Output Current
IRIPPLE			4.73	Amps	Output Capacitor RMS Ripple Current
CMS			1221	Cmils	Secondary Bare Conductor minimum circular mils
AWGS			19	AWG	Secondary Wire Gauge (Rounded up to next larger standard AWG value)
DIAS			0.91	mm	Secondary Minimum Bare Conductor Diameter
ODS			3.05	mm	Secondary Maximum Outside Diameter for Triple Insulated Wire
INSS			1.07	mm	Maximum Secondary Insulation Wall Thickness
VOLTAGE STRESS PARAMETERS					
VDRAIN		Warning	796	Volts	!!! REDUCE DRAIN VOLTAGE Vdrain<680, reduce VACMAX, reduce VOR
PIVS			36	Volts	Output Rectifier Maximum Peak Inverse Voltage
PIVB			84	Volts	Bias Rectifier Maximum Peak Inverse Voltage
TRANSFORMER SECONDARY DESIGN PARAMETERS (MULTIPLE OUTPUTS)					
1st output					
VO1	5		5	Volts	Output Voltage
IO1	0.5		0.5	Amps	Output DC Current
PO1			2.50	Watts	Output Power
VD1	0.6		0.6	Volts	Output Diode Forward Voltage Drop
NS1			4.07		Output Winding Number of Turns
ISRMS1			0.791	Amps	Output Winding RMS Current
IRIPPLE1			0.61	Amps	Output Capacitor RMS Ripple Current
PIVS1			37	Volts	Output Rectifier Maximum Peak Inverse Voltage
CMS1			158	Cmils	Output Winding Bare Conductor minimum circular mils
AWGS1			28	AWG	Wire Gauge (Rounded up to next larger standard AWG value)
DIAS1			0.32	mm	Minimum Bare Conductor Diameter
ODS1			3.00	mm	Maximum Outside Diameter for Triple Insulated Wire
2nd output					
VO2	14			Volts	Output Voltage



IO2	1.2			Amps	Output DC Current
PO2			16.80	Watts	Output Power
VD2	1			Volts	Output Diode Forward Voltage Drop
NS2			10.91		Output Winding Number of Turns
ISRMS2			1.897	Amps	Output Winding RMS Current
IRIPPLE2			1.47	Amps	Output Capacitor RMS Ripple Current
PIVS2			99	Volts	Output Rectifier Maximum Peak Inverse Voltage
CMS2			379	Cmils	Output Winding Bare Conductor minimum circular mils
AWGS2			24	AWG	Wire Gauge (Rounded up to next larger standard AWG value)
DIAS2			0.51	mm	Minimum Bare Conductor Diameter
ODS2			1.12	mm	Maximum Outside Diameter for Triple Insulated Wire



9 Performance Data

9.1 Efficiency

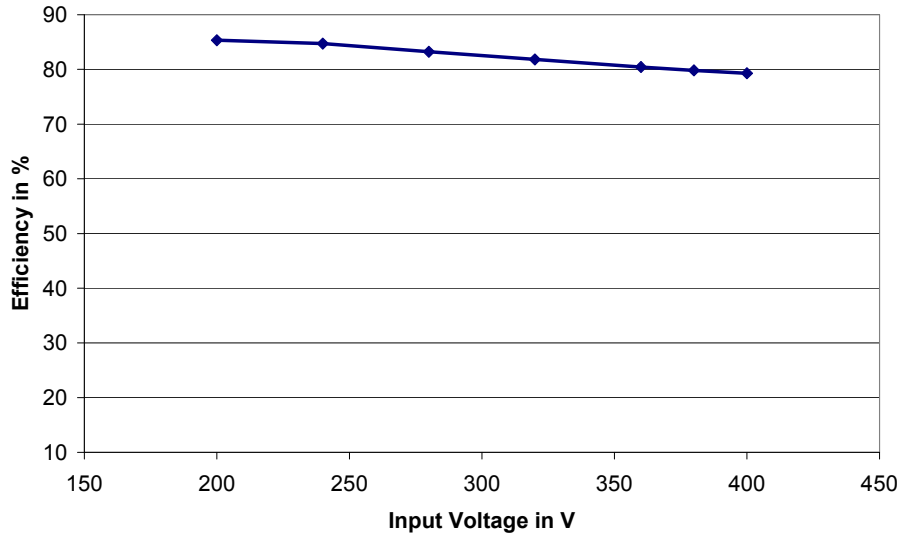

Figure 6 – Efficiency vs. Input Voltage, Room Temperature, 50 Hz.

9.2 No-load Input Power

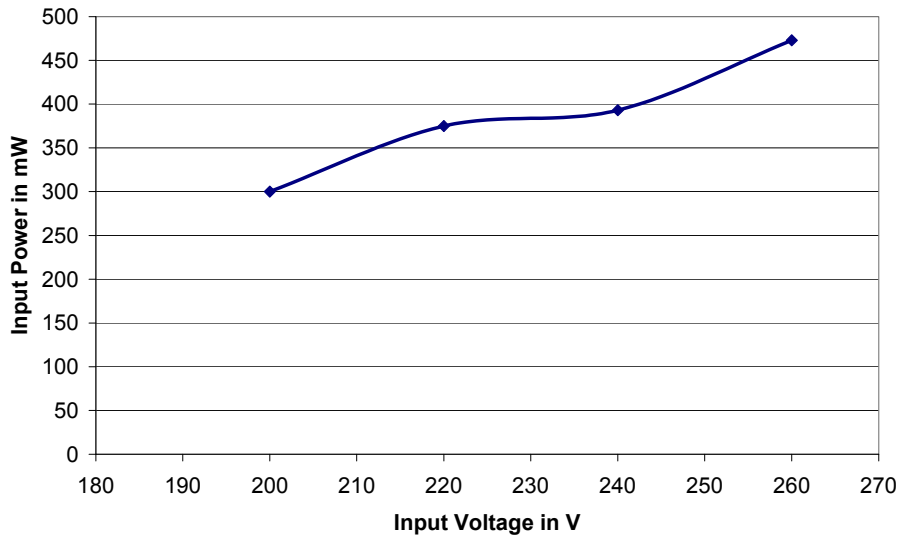

Figure 7 – Zero Load Input Power vs. Input Line Voltage, Room Temperature, 50 Hz.



9.3 Regulation

9.3.1 Load

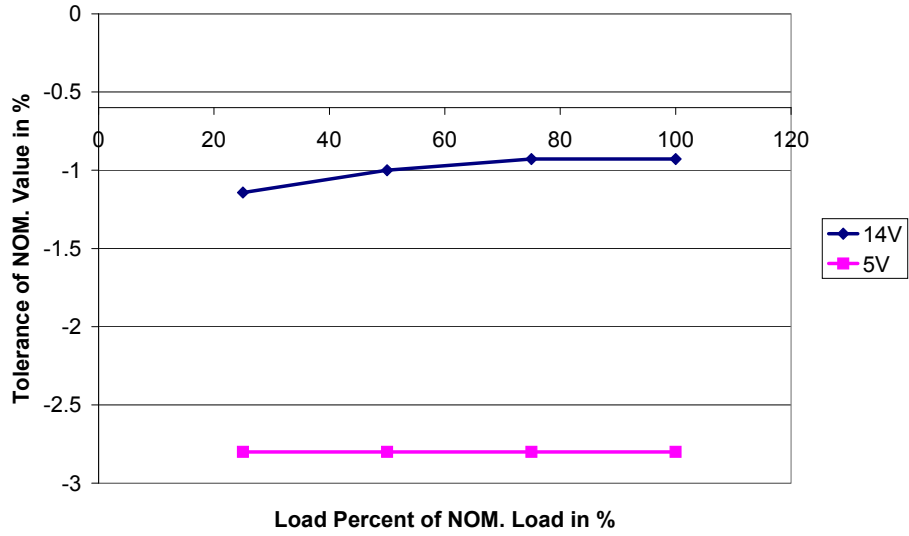

Figure 8 – Load Regulation, Room Temperature.

9.3.2 Line

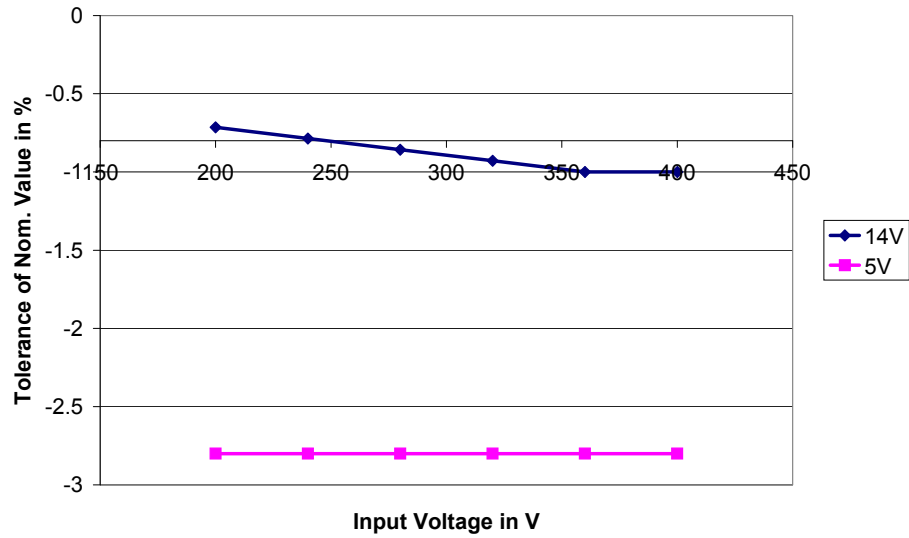

Figure 9 – Line Regulation, Room Temperature, Full Load.



10 Thermal Performance

Temperature (°C)			
Item	200 VAC	300 VAC	400 VAC
Ambient	29	29	29
MOSFET (Q1)	46	44.8	50.8
TOPSwitch-GX (U1)	60.5	52.6	52.6
Transformer (T3)	61.8	63	63.6
Rectifier (D7)	79.9	73.6	72.4



11 Waveforms

11.1 Drain Voltage and Current, Normal Operation

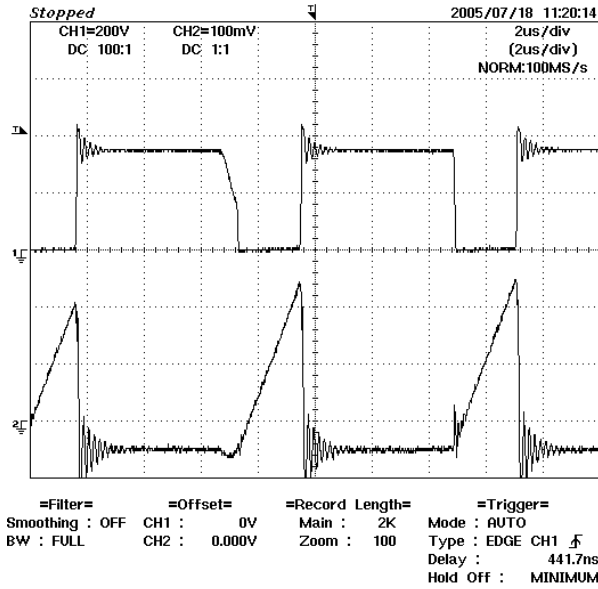

Figure 10 – 200 VAC, Full Load.
 Upper: I_{DRAIN} , 0.2 A / div.
 Lower: V_{DRAIN} , 200 V, 2 μ s / div.

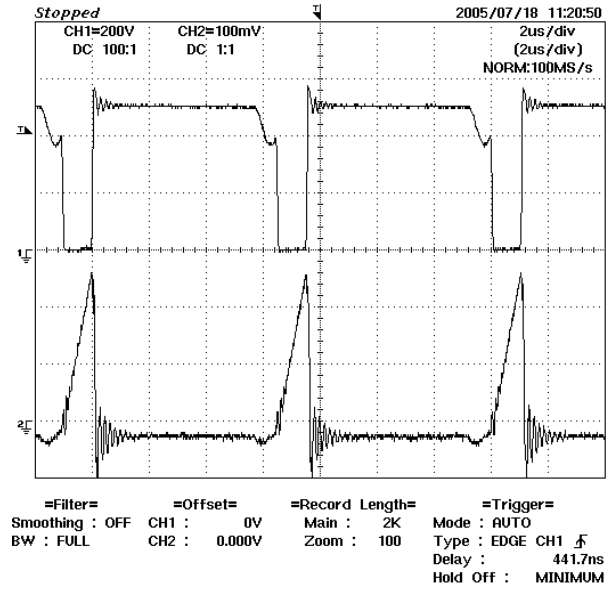

Figure 11 – 400 VAC, Full Load.
 Upper: I_{DRAIN} , 0.2 A / div.
 Lower: V_{DRAIN} , 200 V / div.

11.2 Output Voltage Start-up Profile

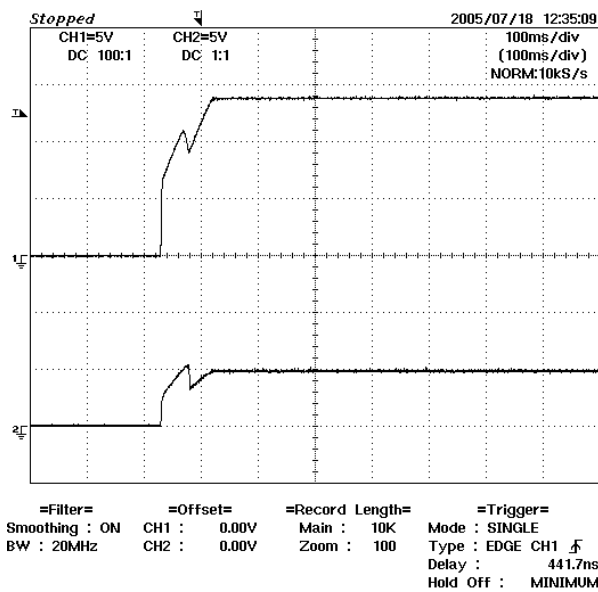

Figure 12 – Start-up Profile, 200 VAC.
 100 ms / div.
 Upper: 12 V.
 Lower: 5 V.

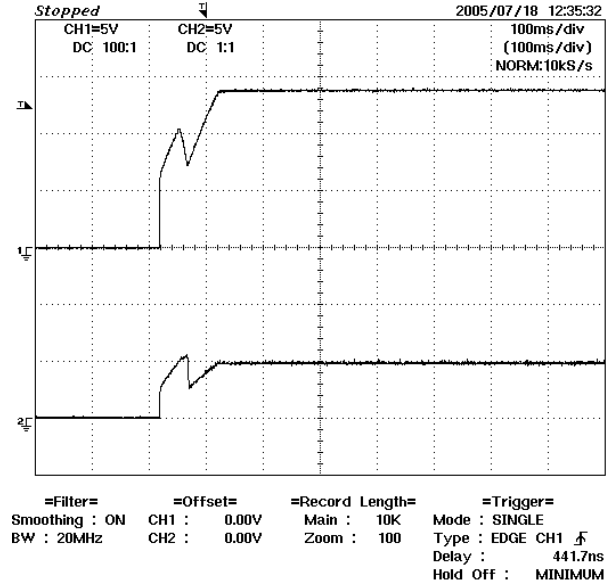

Figure 13 – Start-up Profile, 400 VAC.
 100 ms / div.
 Upper: 12 V.
 Lower: 5 V.



11.3 Drain Voltage and Current Start-up Profile

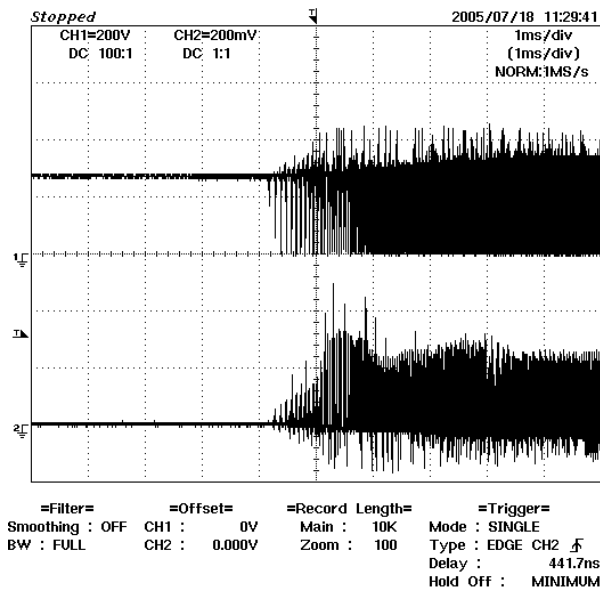

Figure 14 – 200 VAC Input and Maximum Load.
 Upper: I_{DRAIN} , 0.5 A / div.
 Lower: V_{DRAIN} , 100 V & 1 ms / div.

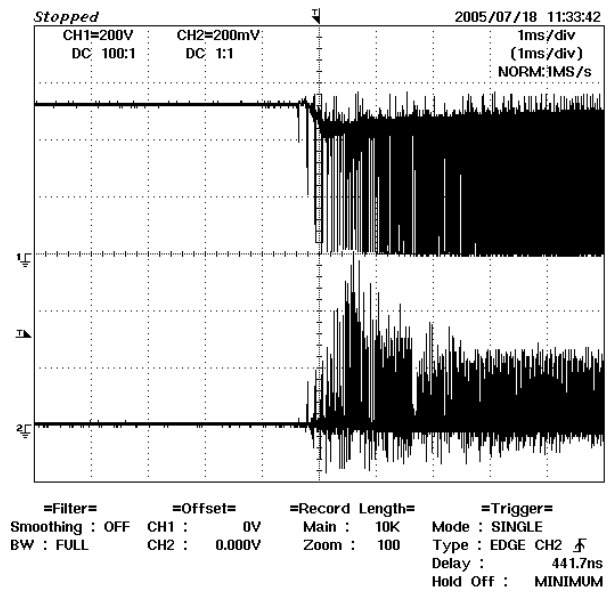

Figure 15 – 400 VAC Input and Maximum Load.
 Upper: I_{DRAIN} , 0.5 A / div.
 Lower: V_{DRAIN} , 200 V & 1 ms / div.



11.4 Load Transient Response (75% to 100% Load Step)

In the figures shown below, signal averaging was used to better enable viewing the load transient response. The oscilloscope was triggered using the load current step as a trigger source. Since the output switching and line frequency occur essentially at random with respect to the load transient, contributions to the output ripple from these sources will average out, leaving the contribution only from the load step response.

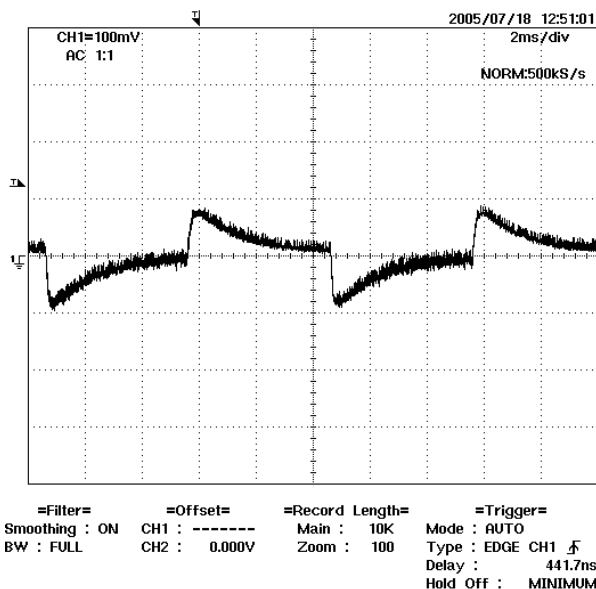

Figure 16 – Transient Response, 200 VAC, 75-100-75% Load Step. 5 V Output Voltage. 100 mV, 5 ms / div.

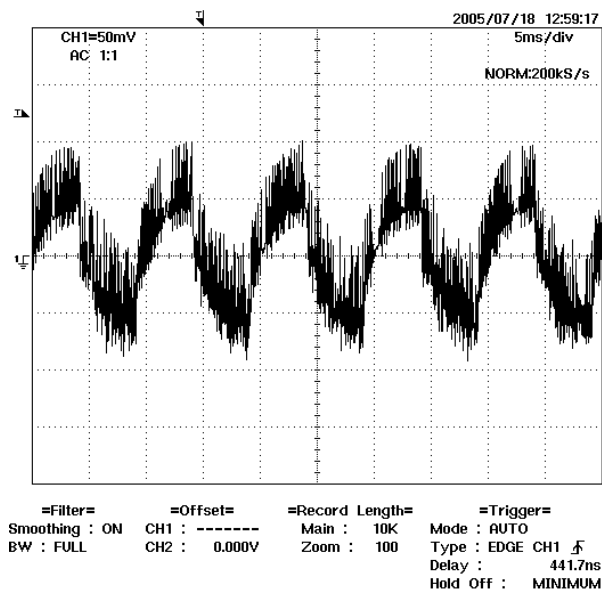

Figure 17 – Transient Response, 200 VAC, 75-100-75% Load Step. 14 V Output Voltage. 100 mV, 5 ms / div.

11.5 Output Ripple Measurements

11.5.1 Ripple Measurement Technique

For DC output ripple measurements, a modified oscilloscope test probe must be utilized in order to reduce spurious signals due to pick-up. Details of the probe modification are provided in in the figures below.

The 5125BA probe adapter is affixed with two capacitors tied in parallel across the probe tip. The capacitors include one (1) 0.1 μF / 50 V ceramic type and one (1) 1.0 μF / 50 V aluminum electrolytic. **The aluminum electrolytic type capacitor is polarized, so proper polarity across DC outputs must be maintained (see below).**

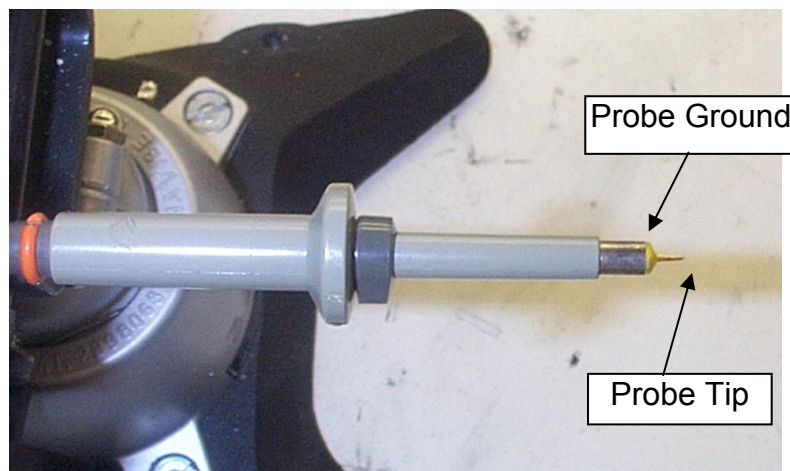

Figure 18 – Oscilloscope Probe Prepared for Ripple Measurement. (End Cap and Ground Lead Removed)

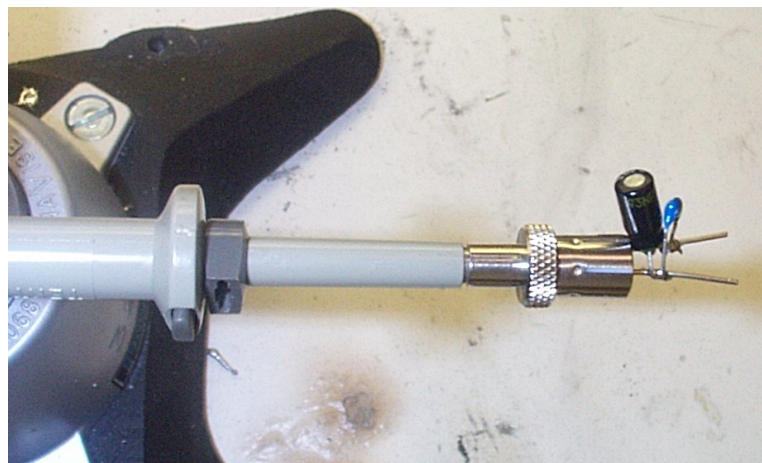

Figure 19 – Oscilloscope Probe with Probe Master 5125BA BNC Adapter. (Modified with wires for probe ground for ripple measurement, and two parallel decoupling capacitors added)

11.5.2 Measurement Results

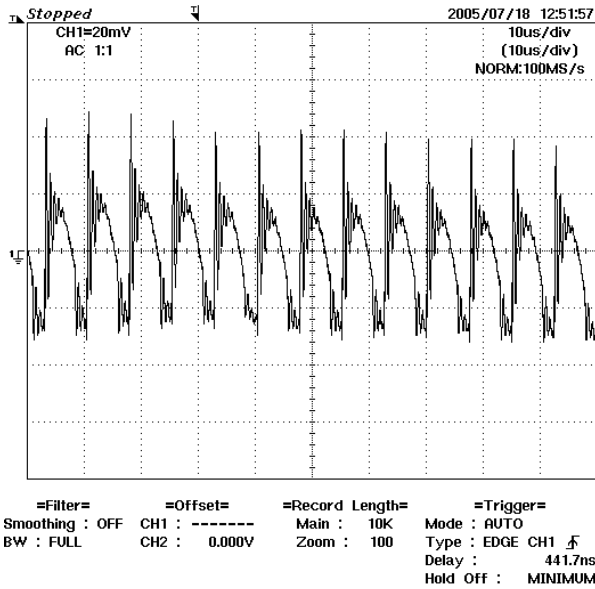

Figure 20 – 5 V Ripple, 200 VAC, Full Load.
 10 µs, 20 mV / div.

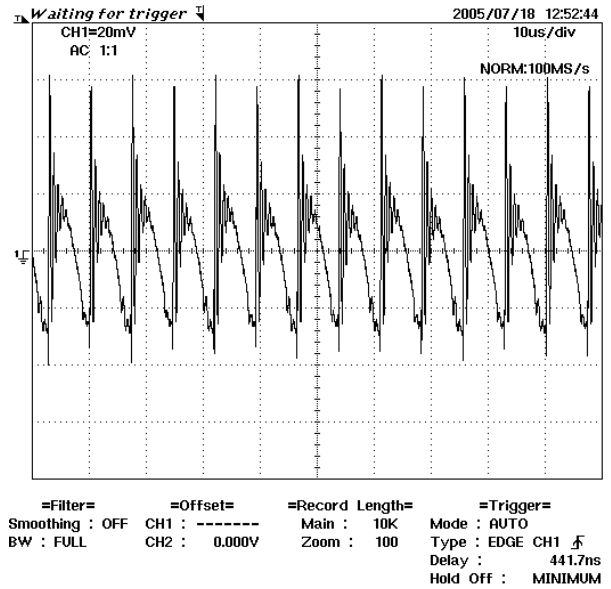

Figure 21 – 5 V Ripple, 400 VAC, Full Load.
 10 µs, 20 mV / div.

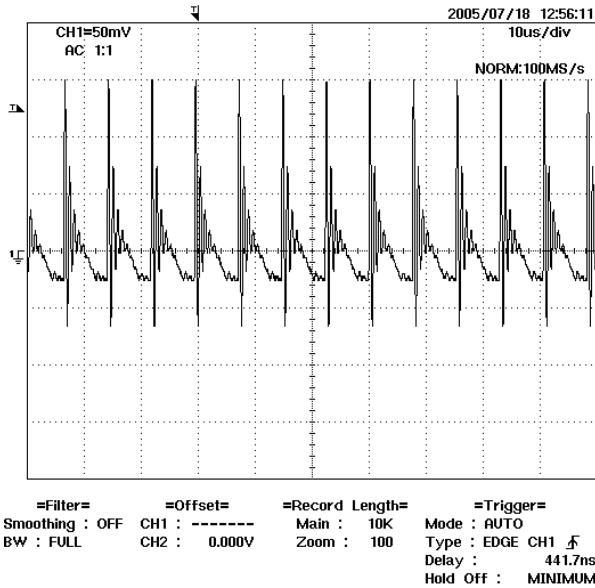

Figure 22 – 14 V Ripple, 200 VAC, Full Load.
 2 ms, 50 mV /div.

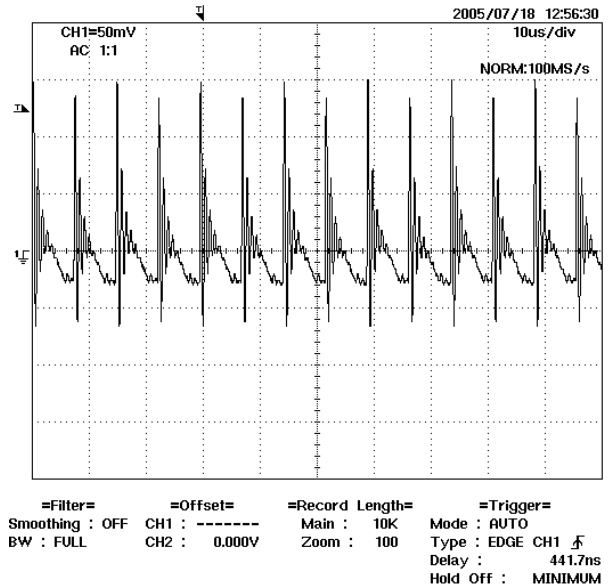

Figure 23 – 14 V Ripple, 400 VAC, Full Load.
 2 ms, 50 mV /div.

12 Conducted EMI

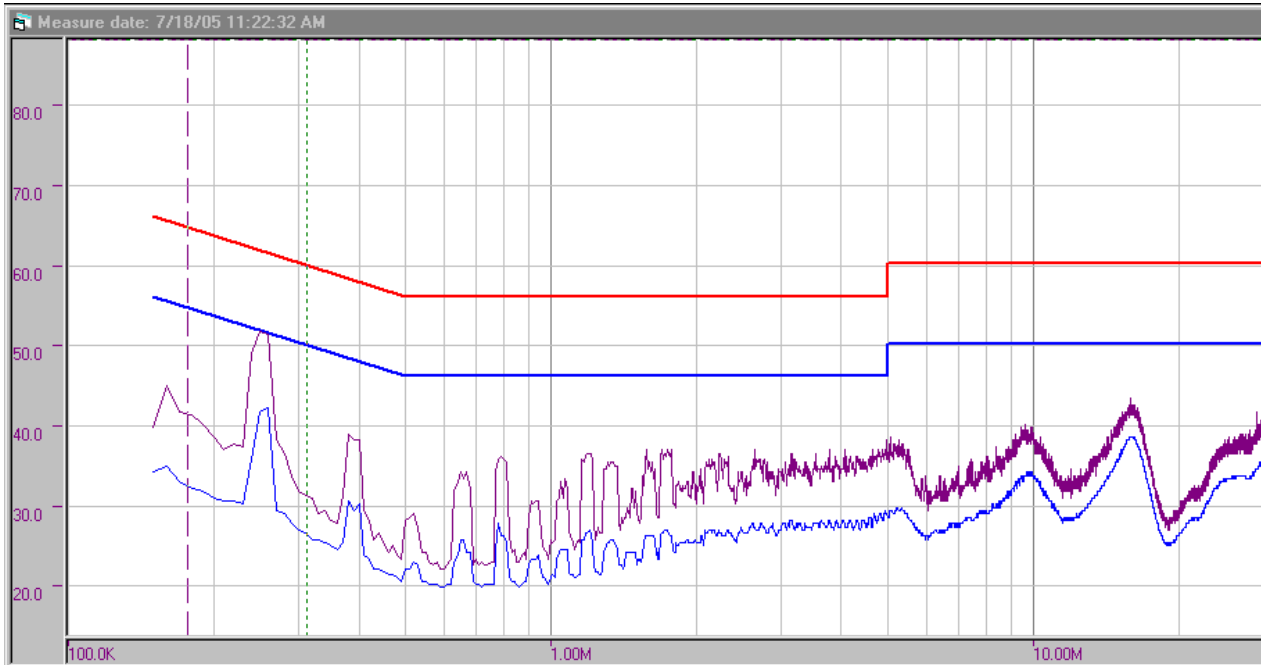

Figure 24 – Conducted EMI, Maximum Steady-State Load, 200 VAC, 50 Hz, and EN55022 B Limits.

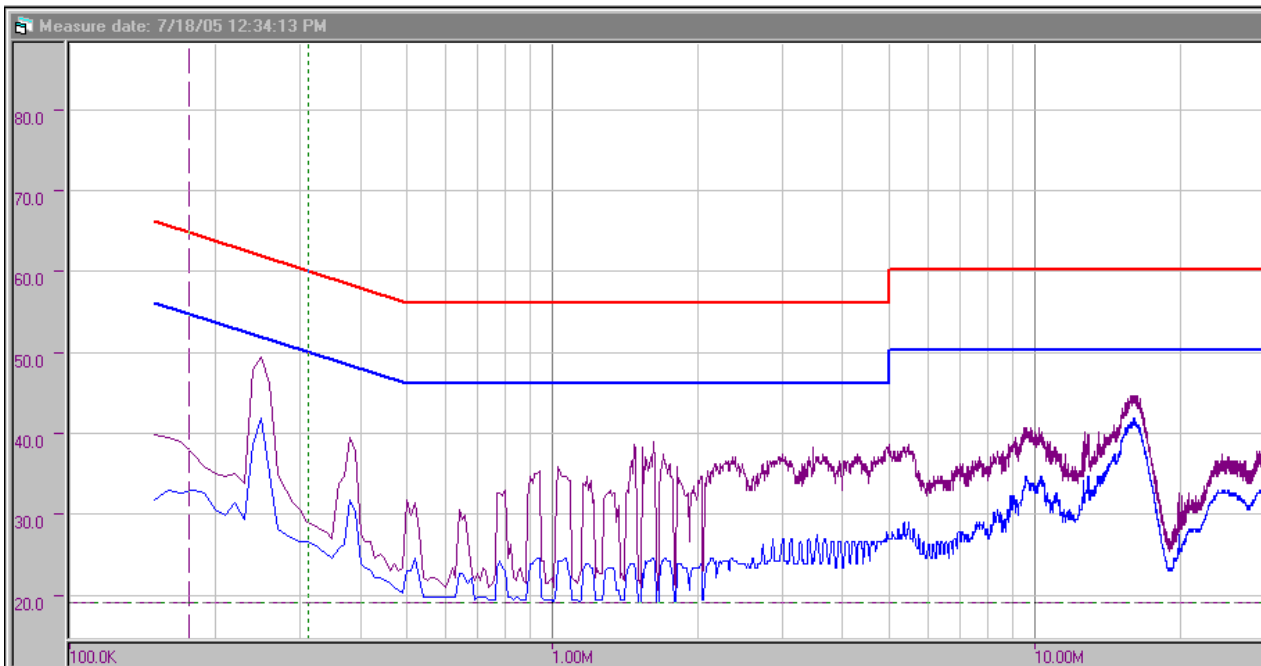

Figure 25 – Conducted EMI, Maximum Steady-State Load, 300 VAC, 50 Hz, and EN55022 B Limits.



13 Revision History

Date	Author	Revision	Description & changes	Reviewed
26-Oct-05	HM	1.0	Initial Release	KM/JC/VC
23-Jul-12	KM	1.1	Trademark and text updates	



For the latest updates, visit our website: www.powerint.com

Power Integrations reserves the right to make changes to its products at any time to improve reliability or manufacturability. Power Integrations does not assume any liability arising from the use of any device or circuit described herein. POWER INTEGRATIONS MAKES NO WARRANTY HEREIN AND SPECIFICALLY DISCLAIMS ALL WARRANTIES INCLUDING, WITHOUT LIMITATION, THE IMPLIED WARRANTIES OF MERCHANTABILITY, FITNESS FOR A PARTICULAR PURPOSE, AND NON-INFRINGEMENT OF THIRD PARTY RIGHTS.

PATENT INFORMATION

The products and applications illustrated herein (including transformer construction and circuits' external to the products) may be covered by one or more U.S. and foreign patents, or potentially by pending U.S. and foreign patent applications assigned to Power Integrations. A complete list of Power Integrations' patents may be found at www.powerint.com. Power Integrations grants its customers a license under certain patent rights as set forth at <http://www.powerint.com/ip.htm>.

The PI Logo, TOPSwitch, TinySwitch, LinkSwitch, DPA-Switch, PeakSwitch, CAPZero, SENZero, LinkZero, HiperPFS, HiperTFS, HiperLCS, Qspeed, EcoSmart, Clampless, E-Shield, Filterfuse, StackFET, PI Expert and PI FACTS are trademarks of Power Integrations, Inc. Other trademarks are property of their respective companies. ©Copyright 2012 Power Integrations, Inc.

Power Integrations Worldwide Sales Support Locations

WORLD HEADQUARTERS

5245 Hellyer Avenue
San Jose, CA 95138, USA.
Main: +1-408-414-9200
Customer Service:
Phone: +1-408-414-9665
Fax: +1-408-414-9765
e-mail: usasales@powerint.com

GERMANY

Lindwurmstrasse 114
80337, Munich
Germany
Phone: +49-895-527-39110
Fax: +49-895-527-39200
e-mail: eurosales@powerint.com

JAPAN

Kosei Dai-3 Building
2-12-11, Shin-Yokohama,
Kohoku-ku, Yokohama-shi,
Kanagawa 222-0033
Japan
Phone: +81-45-471-1021
Fax: +81-45-471-3717
e-mail: japansales@powerint.com

TAIWAN

5F, No. 318, Nei Hu Rd.,
Sec. 1
Nei Hu District
Taipei 114, Taiwan R.O.C.
Phone: +886-2-2659-4570
Fax: +886-2-2659-4550
e-mail: taiwansales@powerint.com

CHINA (SHANGHAI)

Rm 1601/1610, Tower 1
Kerry Everbright City
No. 218 Tianmu Road West
Shanghai, P.R.C. 200070
Phone: +86-021-6354-6323
Fax: +86-021-6354-6325
e-mail: chinasales@powerint.com

INDIA

#1, 14th Main Road
Vasanthanagar
Bangalore-560052
India
Phone: +91-80-4113-8020
Fax: +91-80-4113-8023
e-mail: indiasales@powerint.com

KOREA

RM 602, 6FL
Korea City Air Terminal B/D,
159-6
Samsung-Dong, Kangnam-Gu,
Seoul, 135-728 Korea
Phone: +82-2-2016-6610
Fax: +82-2-2016-6630
e-mail: koreasales@powerint.com

EUROPE HQ

1st Floor, St. James's House
East Street, Farnham
Surrey GU9 7TJ
United Kingdom
Phone: +44 (0) 1252-730-141
Fax: +44 (0) 1252-727-689
e-mail: eurosales@powerint.com

CHINA (SHENZHEN)

3rd Floor, Block A, Zhongtuo
International Business Center, No.
1061, Xiang Mei Road, FuTian District,
ShenZhen, China, 518040
Phone: +86-755-8379-3243
Fax: +86-755-8379-5828
e-mail: chinasales@powerint.com

ITALY

Via Milanese 20, 3rd Fl.
20099 Sesto San Giovanni
(MI) Italy
Phone: +39-024-550-8701
Fax: +39-028-928-6009
e-mail: eurosales@powerint.com

SINGAPORE

51 Newton Road,
#19-01/05 Goldhill Plaza
Singapore, 308900
Phone: +65-6358-2160
Fax: +65-6358-2015
e-mail: singaporesales@powerint.com

APPLICATIONS HOTLINE

World Wide +1-408-414-9660

APPLICATIONS FAX

World Wide +1-408-414-9760

