Design Example Report

Title	<i>32 W Non-Dimmable, High Efficiency (>90%), Power Factor Corrected, Non-Isolated Buck LED Driver Using LYTSwitch™-1 LYT1604D</i>
Specification	90 VAC – 132 VAC Input; 60 V _{TYP} , 260 mA _{TYP} Dual Output
Application	Downlight
Author	Applications Engineering Department
Document Number	DER-556
Date	August 17, 2016
Revision	1.0

Summary and Features

- Single-stage power factor corrected, PF >0.9
- Accurate constant current regulation for both output, ±5%
- Meets <30% flicker requirement for each output
- Highly energy efficient, >90% at 115 V
- Low cost and low component count for compact PCB solution
- Integrated protection features
 - No-load output protection
 - Output short-circuit protection
 - Overcurrent protection
 - Thermal fold-back protection
 - Over temperature protection
 - No damage during line brown-out or brown-in conditions
- Meets IEC 2.5 kV ring wave, 1 kV differential surge
- Meets EN55015 conducted EMI

Power Integrations

5245 Hellyer Avenue, San Jose, CA 95138 USA.
Tel: +1 408 414 9200 Fax: +1 408 414 9201
www.power.com

PATENT INFORMATION

The products and applications illustrated herein (including transformer construction and circuits external to the products) may be covered by one or more U.S. and foreign patents, or potentially by pending U.S. and foreign patent applications assigned to Power Integrations. A complete list of Power Integrations' patents may be found at www.powerint.com. Power Integrations grants its customers a license under certain patent rights as set forth at <http://www.powerint.com/ip.htm>.



Table of Contents

1	Introduction	5
2	Power Supply Specification	8
3	Schematic	9
4	Circuit Description	10
4.1	Input Stage	10
4.2	EMI Filter	10
4.3	LYTSwitch-1 Control Circuit	10
5	PCB Layout	13
6	Bill of Materials	15
7	Inductor Specification	16
7.1	Electrical Diagram	16
7.2	Electrical Specifications	16
7.3	Material List	16
7.4	Inductor Build Diagram	17
7.5	Inductor Construction	17
7.6	Winding Illustrations	18
8	Inductor Design Spreadsheet	20
9	Performance Data	22
9.1	Efficiency	22
9.2	Line Regulation	23
9.3	Power Factor	24
9.4	%ATHD	25
10	Test Data	26
10.1	Test Data, 57 V LED Loads	26
10.2	Test Data, 60 V LED Loads	26
10.3	Test Data, 63 V LED Loads	26
11	Thermal Performance	27
11.1	Thermal Performance Scan – Open Frame Unit	27
11.1.1	Thermal Scan at Normal Operation 115 V, 60 V LED Loads	28
11.1.2	Thermal Scan During Output_1 Short-Circuit at 115 VAC Input	30
11.1.3	Thermal Scan During Output_2 Short-Circuit at 115 VAC Input	30
11.2	Thermal Performance Inside Chamber – Open Frame Unit	31
11.2.1	Thermal Performance at 115VAC with a 60 V LED Loads	32
11.2.2	Thermal Performance at 90 VAC with a 60 V LED Loads	34
12	Waveforms	36
12.1	Input Voltage and Input Current Waveforms	36
12.2	Start-up Profile	37
12.3	Output Current Fall	39
12.4	Drain Voltage and Current in Normal Operation	40
12.5	Drain Voltage and Current Start-up Profile	44
12.6	Drain Voltage and Current During Output Short-Circuit	46
12.7	Output Diode Voltage and Current in Normal Operation	47

12.8	Output Voltage and Current – Open Output LED Load.....	49
12.9	Output Voltage and Current – Start-up at Open Output Load.....	50
12.10	Output Ripple Current.....	51
13	AC Cycling Test.....	52
14	Conducted EMI	53
14.1	Test Set-up	53
14.1.1	Equipment and Load Used	53
14.2	EMI Test Result	54
15	Line Surge.....	56
16	Brown-in / Brown-out Test	57
17	Revision History	58

Important Note: Although this board is designed to satisfy safety isolation requirements, the engineering prototype has not been agency approved. Therefore, all testing should be performed using an isolation transformer to provide the AC input to the prototype board.



1 Introduction

This engineering report describes a low component count, non-isolated, non-dimmable LED driver in buck topology, designed to drive a dual output 60 V LED voltage string at 260 mA output current each from an input voltage range of 90 VAC to 132 VAC. The LED drivers utilize the LYT1604D from the LYTSwitch-1 family of devices.

The LYTSwitch-1 IC is a SO-8 package LED driver controller designed for non-isolated buck topology applications. The LYTSwitch-1 family of ICs provide high efficiency, high power factor and accurate LED current regulation. LYTSwitch-1 ICs incorporate a high-voltage power MOSFET and variable frequency / variable on-time, critical conduction mode control engine for accurate current regulation, high power factor and proprietary MOSFET utilization for high efficiency. The controller also integrates protection features such as input and output overvoltage protection, thermal fold-back, over temperature shutdown, output short-circuit and overcurrent protection.

DER-556 offers a compact size solution for 32 W LED drivers for bulb applications. The key design goals were high efficiency, accurate constant current regulation for both outputs and low component count.

The document contains the power supply specification, schematic, bill of materials, transformer documentation, printed circuit layout, design spreadsheet, and performance data.

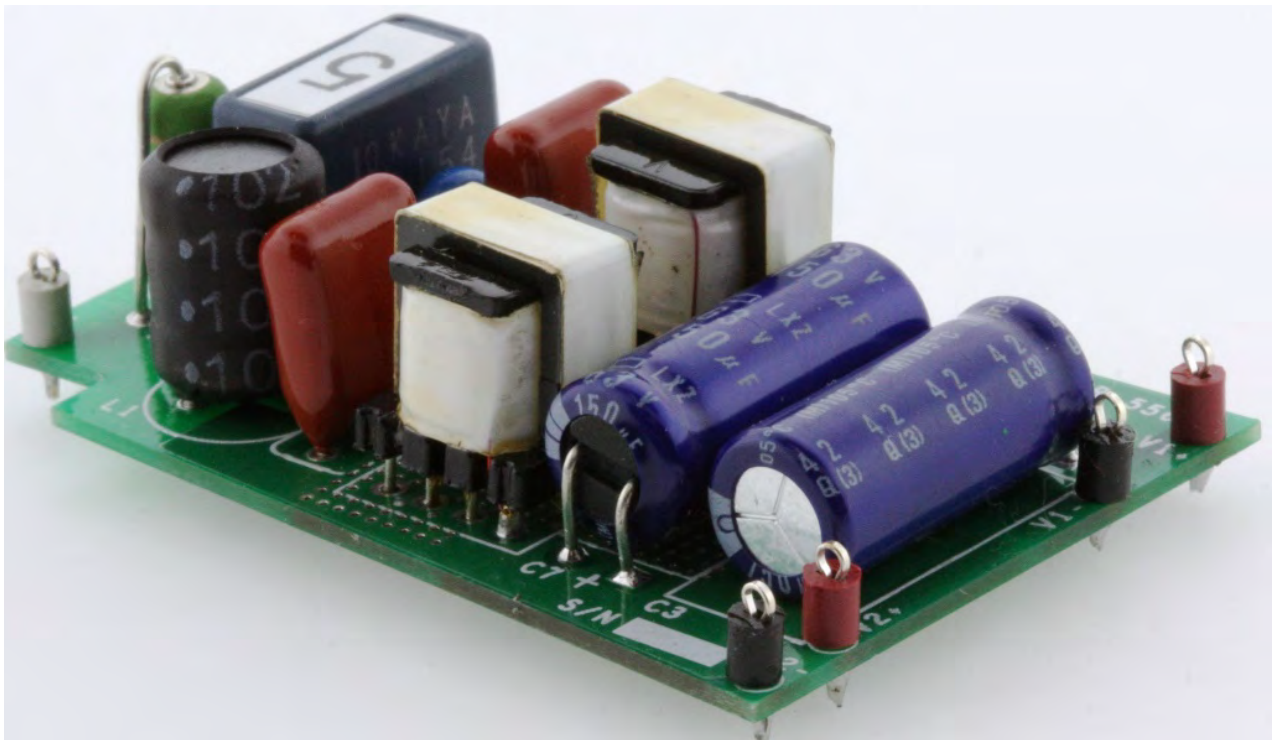

Figure 1 – Populated Circuit Board.

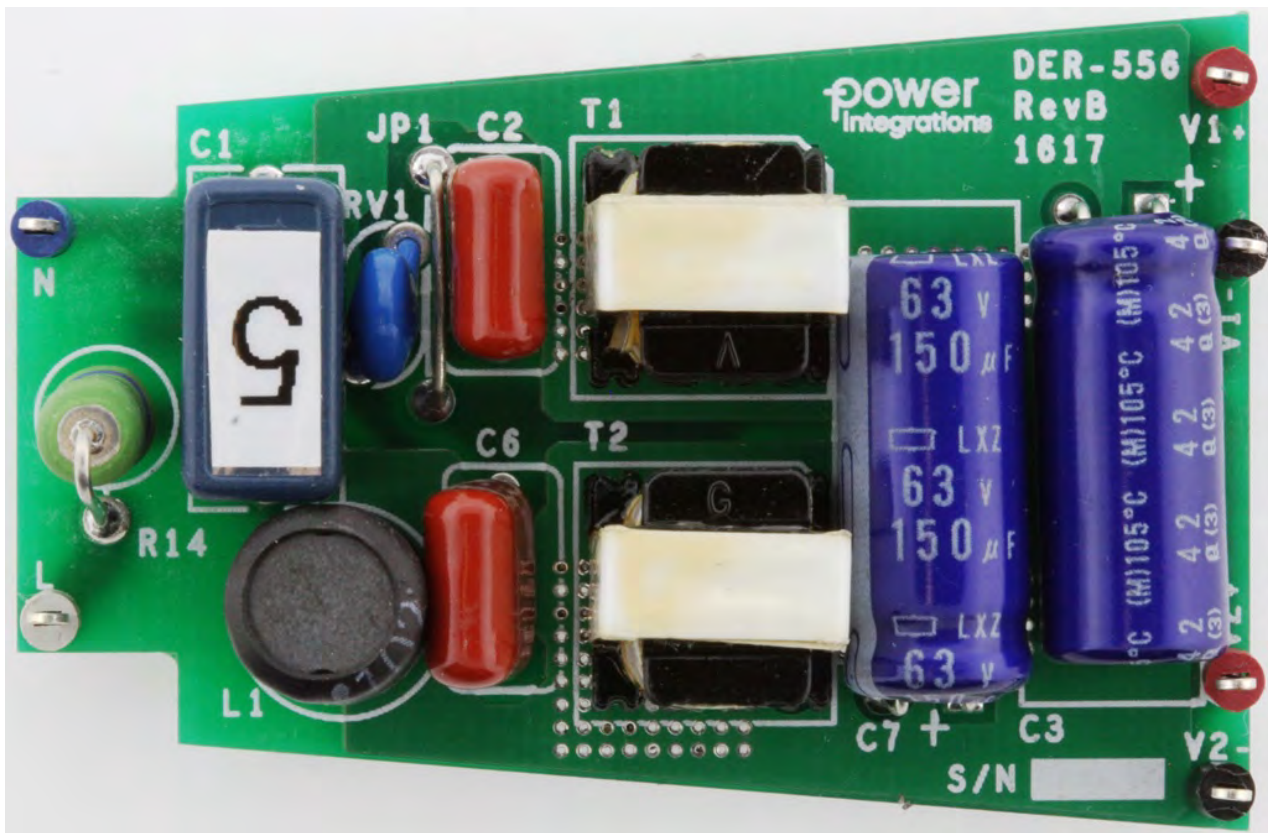

Figure 2 – Populated Circuit Board, Top View.

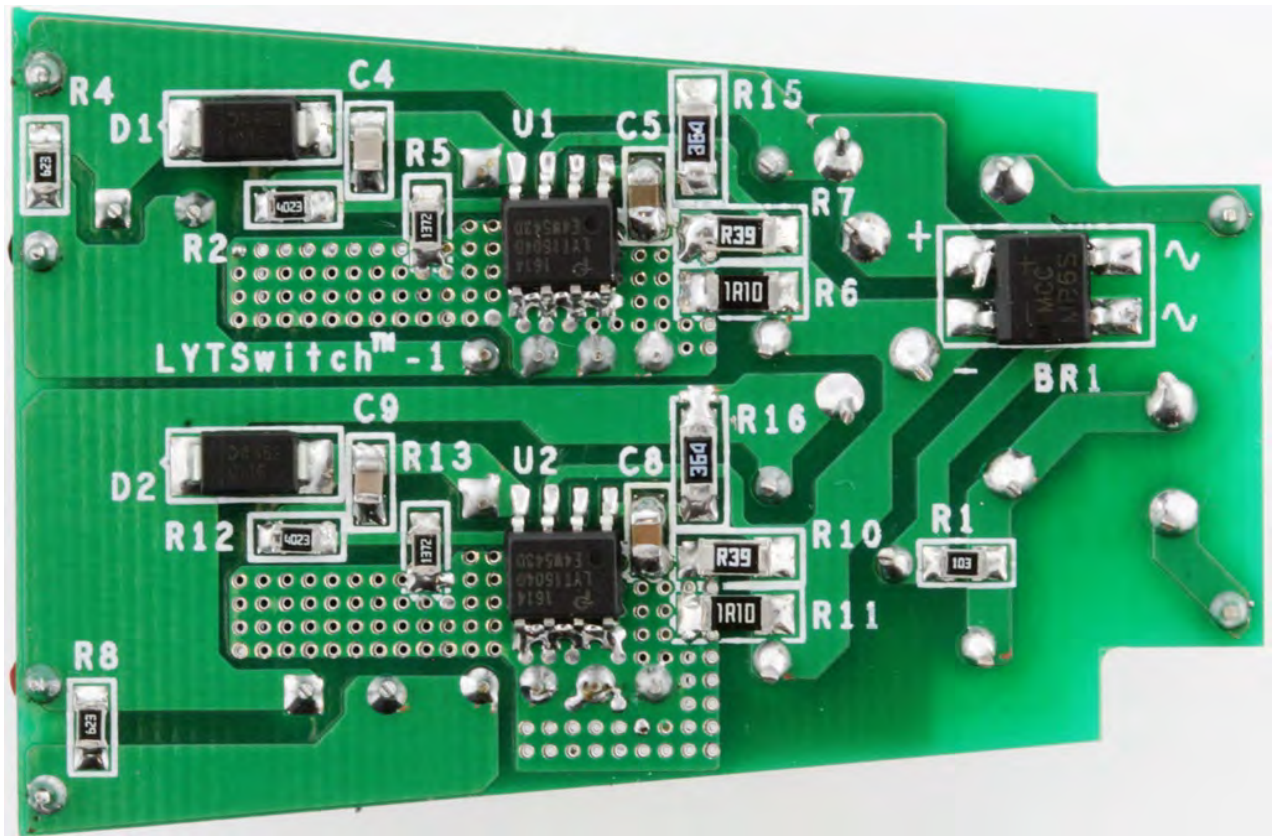

Figure 3 – Populated Circuit Board, Bottom View.

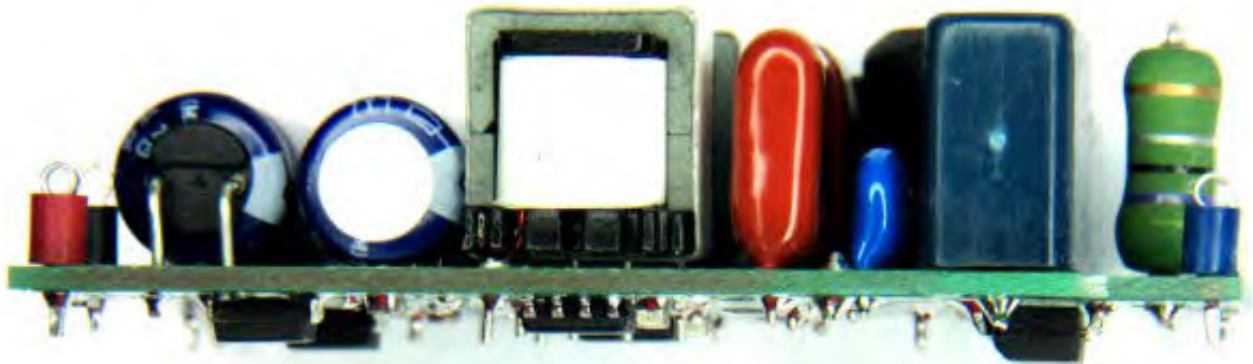

Figure 4 – Populated Circuit Board, Side View.

2 Power Supply Specification

The table below represents the minimum acceptable performance of the design. Actual performance is listed in the results section.

Description	Symbol	Min	Typ	Max	Units	Comment
Input						
Voltage	V_{IN}	90	115	132	VAC	2 Wire – no P.E.
Frequency	f_{LINE}		60		Hz	
Output						
Output Voltage 1	V_{OUT1}		60		V	
Output Current 1	I_{OUT1}		260		mA	
Output Voltage 2	V_{OUT2}		60		V	
Output Current 2	I_{OUT2}		260		mA	
Total Output Power			32		W	
Continuous Output Power	P_{OUT}		32		W	
Efficiency						
Full Load	η		90		%	115 V / 50 Hz at 25 °C.
Environmental						
Conducted EMI			CISPR 15B / EN55015B			
Safety			Non-Isolated			
Ring Wave (100 kHz)			2.5		kV	
Differential Mode (L1-L2)			1.0		kV	
Power Factor			0.9			Measured at 115 VAC / 50 Hz.
Ambient Temperature	T_{AMB}			75	°C	Free Convection, Sea Level.

3 Schematic

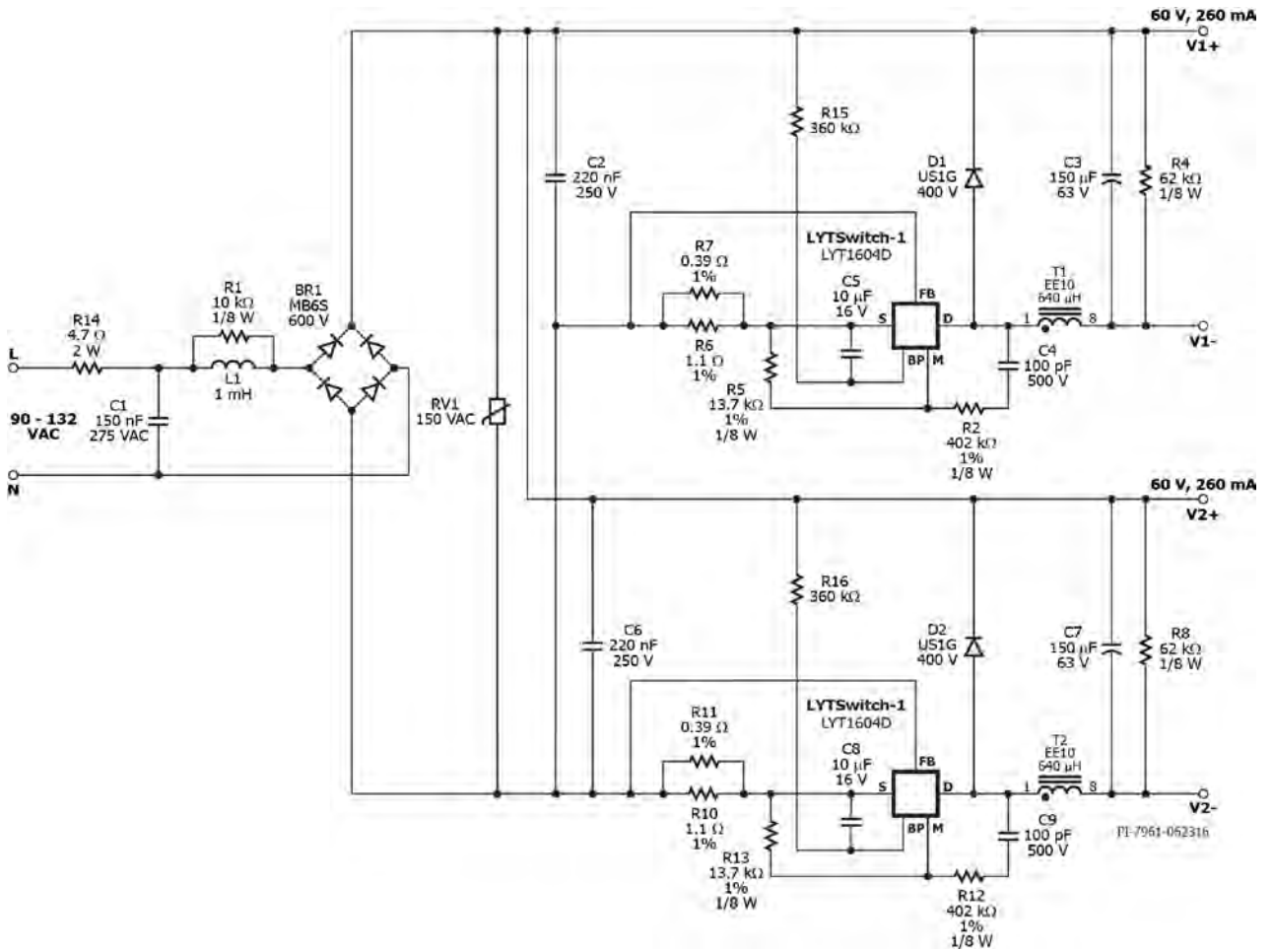

Figure 5 – Schematic.

4 Circuit Description

The LYTSwitch-1 device (U1-LYT1604D) combines a high-voltage power MOSFET and variable frequency / variable on-time, critical conduction mode controller in a single SO-8 package. The LYT1604D IC is configured to drive a 60 V output non-isolated buck LED driver with 260 mA constant current output. The LYT1604D device was selected from the power table based on maximum output power (18 W for low line).

4.1 Input Stage

The input fuse R14 provides safety protection. Varistor RV1 acts as a voltage clamp that limits the voltage spike on the primary during line transient voltage surge events. A 150 VAC rated part was selected, being slightly above the maximum specified operating input voltage (132 VAC). The AC input voltage is full wave rectified by BR1 to achieve good power factor and low THD.

4.2 EMI Filter

Inductor L1 serves as differential choke. Resistor R1 damps the LC resonance caused by filter components and the AC line impedance which would cause an increase in conducted EMI measurements. Inductor L1, C1 and C2/C6 form as an EMI pi filter which works to filter differential and common mode noise. LYTSwitch-1's variable frequency / on-time and critical conduction control engine limit RFI emission to significant level which enables design to use simple EMI pi filter even for high power bulb and tube applications.

4.3 LYTSwitch-1 Control Circuit

The LED driver circuit topology is a low side buck where the MOSFET of U1 / U2 and the inductor T1 / T2 are connected at the ground rail. During the MOSFET on-time, current ramps through the inductor winding, storing energy in the form of magnetic field which is then delivered to the output load via flywheel diode D1 / D2 during the MOSFET off-time.

The output capacitors C3 / C7 provide output voltage ripple filtering to minimize the output ripple current. To avoid long ghosting effect of light output after power off, resistors R4 / R8 preload discharges the output capacitors voltage below LED voltage.

Capacitors C5 and C8 provide local decoupling for the BYPASS (BP) pin of U1 and U2 respectively, which provide power to the IC during the switch on-time. The IC internal regulator draws power from high-voltage DRAIN (D) pin and charge the bypass capacitor C5 / C8 during the power switch off-time. The typical BP pin voltage is 5.22 V. To keep the IC operating normally especially during the dead zone, where $V_{IN} < V_{OUT}$, the value of capacitor should be large enough to keep the bypass voltage above the $V_{BP(RESET)}$ value of 4.5 V. Recommended minimum value for the bypass capacitor is 4.7 μ F.

Constant output current regulation is achieved through the FEEDBACK (FB) pin directly sensing the drain current during the MOSFET on-time using external current sense



resistors (R_{FB}) R6 / R7 and R10 / R11 and comparing the voltage drop to a fixed internal reference voltage ($V_{FB(REF)}$) of absolute value 280 mV typical.

$$R_{FB} = V_{FB_REF} / k \times I_{OUT}$$

Where: k is the ratio between I_{PK} and I_{OUT} ; such that k = 3 for LYT14xx, and k = 3.6 for LYT16xx)

Trimming R_{FB} may be necessary to center I_{OUT} at the nominal input voltage.

The MULTIFUNCTION (M) pin monitors the line for any line overvoltage event. When the internal MOSFET is in on-state, the M pin is shorted to the SOURCE (S) pin in order to detect the rectified input line voltage derived from the voltage across the inductor, i.e. ($V_{IN} - V_{OUT}$) and current flowing out of the M pin is defined by resistors R2 / R12, thus line overvoltage detection is calculated as; where R2 / R12 are assumed to be 402 k Ω \pm 1%.

$$V_{LINE_OVP} = I_{IOV} \times R2 + V_{OUT1}$$

or

$$V_{LINE_OVP} = I_{IOV} \times R12 + V_{OUT2}$$

Once the measured current exceeds the input overvoltage threshold (I_{IOV}) of 1 mA typical, the IC will inhibit switching instantaneously and initiate auto-restart to protect the internal MOSFET of the IC.

The M pin also monitors the output for any overvoltage and undervoltage event. When the internal MOSFET is in off state, the output voltage is monitored through a coupling capacitors C4 / C5 and divider resistors R2 and R12 or R5 and R13. When an output open-load condition occurs, the voltage at the M pin will rise abruptly and when it exceeds the threshold of 2.4 V, the IC will inhibit switching instantaneously and initiate auto-restart to limit the output voltage from further rising. The overvoltage cut-off is typically 120% of the output voltage, which is equivalent to 2 V at the M pin ($V_{OUT_OVP} = V_{OUT} \times 2.4 \text{ V} / 2 \text{ V}$). Resistor R2 and R12 are set to a fixed value of 402 k Ω \pm 1%. Resistor R5 and R13 will determine the output overvoltage limit. Any output short-circuit at the output will be detected once the M pin voltage falls below the undervoltage threshold (V_{OUV}) of 1 V typical, then the IC will inhibit switching instantaneously and initiate auto-restart to limit the average input less than 1 W, preventing any components from overheating.

R5 and R13 can be calculated as follows:

$$R5 = 2 V \times R2 / (V_{OUT1} - 2 V)$$

$R13 = 2 V \times R12 / (V_{OUT2} - 2 V)$; this is applicable only to low-side configuration buck.

Another function of the M pin is for zero current detection (ZCD). This is to ensure operation in critical conduction mode. The inductor demagnetization is sensed when the voltage across the inductor begins to collapse towards zero as flywheel diode (D1) conduction expires.



5 PCB Layout

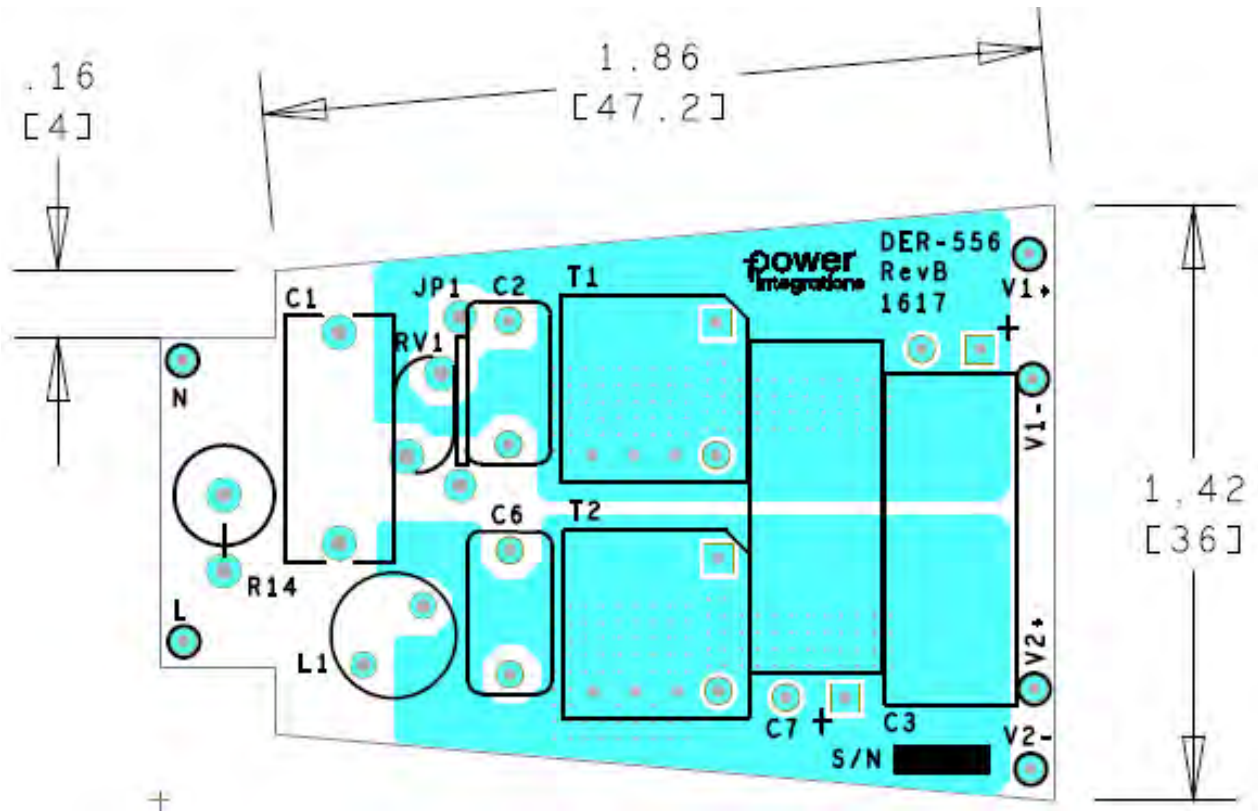

Figure 6 – Top Side



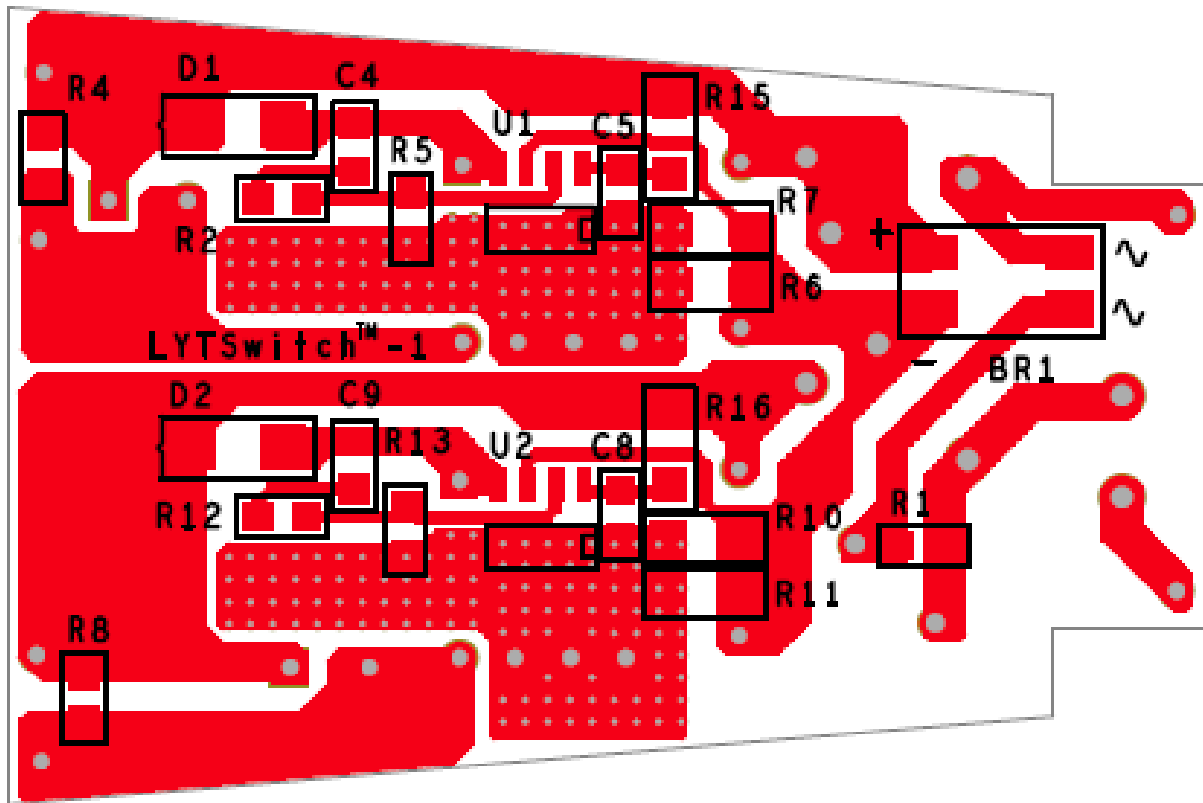

Figure 7 – Bottom Side.

6 Bill of Materials

Item	Ref Des	Qty	Description	Mfg Part Number	Manufacturer
1	BR1	1	600 V, 0.5 A, Bridge Rectifier, SMD, MBS-1, 4-SOIC	MB6S-TP	Micro Commercial
2	C1	1	150 nF, 275 VAC, Film, X2	LE154-M	OKAYA
3	C2	1	220 nF, 250 V, 5%, Film	MEXID3220JJ	Duratech
4	C3	1	150 μ F, 63, Electrolytic, Low ESR, 210 m Ω , (8 x 20)	ELXZ630ELL151MH20D	Nippon Chemi-Con
5	C4	1	100 pF, 500 V, Ceramic, NPO, 0805	501R15N101KV4T	Johanson Dielectrics
6	C5	1	10 μ F, \pm 10%, 16 V, X7R, Ceramic Capacitor, -55 $^{\circ}$ C ~ 125 $^{\circ}$ C, SMT, MLCC 0805 (2012 Metric), 0.079" L x 0.049" W (2.00 mm x 1.25 mm)	CL21B106KOQNNNG	Samsung
7	C6	1	220 nF, 250 V, 5%, Film	MEXID3220JJ	Duratech
8	C7	1	150 μ F, 63, Electrolytic, Low ESR, 210 m Ω , (8 x 20)	ELXZ630ELL151MH20D	Nippon Chemi-Con
9	C8	1	10 μ F, \pm 10%, 16 V, X7R, Ceramic Capacitor, -55 $^{\circ}$ C ~ 125 $^{\circ}$ C, SMT, MLCC 0805 (2012 Metric), 0.079" L x 0.049" W (2.00 mm x 1.25 mm)	CL21B106KOQNNNG	Samsung
10	C9	1	100 pF, 500 V, Ceramic, NPO, 0805	501R15N101KV4T	Johanson Dielectrics
11	D1	1	Diode Ultrafast, GPP, 400 V, 1 A SMA	US1G-13-F	Diodes, Inc.
12	D2	1	Diode Ultrafast, GPP, 400 V, 1 A SMA	US1G-13-F	Diodes, Inc.
13	JP1	1	Wire Jumper, Non-insulated, #22 AWG, 0.4 in	298	Alpha
14	L1	1	1 mH, 0.30 A, Ferrite Core	CTCH895F-102K	CT Parts
15	R1	1	RES, 10 k Ω , 5%, 1/8 W, Thick Film, 0805	ERJ-6GEYJ103V	Panasonic
16	R2	1	RES, 402 k Ω , 1%, 1/8 W, Thick Film, 0805	ERJ-6ENF4023V	Panasonic
17	R4	1	RES, 62 k Ω , 5%, 1/8 W, Thick Film, 0805	ERJ-6GEYJ623V	Panasonic
18	R5	1	RES, 13.7 k Ω , 1%, 1/8 W, Thick Film, 0805	ERJ-6ENF1372V	Panasonic
19	R6	1	RES, 1.1 Ω , 1%, 1/4 W, Thick Film, 1206	RC1206FR-071R1L	Yago
20	R7	1	RES, 0.39 Ω 1/4W, 1%, Thick Film, 1206	ERJ-8RQFR39V	Panasonic
21	R8	1	RES, 62 k Ω , 5%, 1/8 W, Thick Film, 0805	ERJ-6GEYJ623V	Panasonic
22	R10	1	RES, 1.1 Ω , 1%, 1/4 W, Thick Film, 1206	RC1206FR-071R1L	Yago
23	R11	1	RES, 0.39 Ω , 1/4 W, 1%, Thick Film, 1206	ERJ-8RQFR39V	Panasonic
24	R12	1	RES, 402 k Ω , 1%, 1/8 W, Thick Film, 0805	ERJ-6ENF4023V	Panasonic
25	R13	1	RES, 13.7 k Ω , 1%, 1/8 W, Thick Film, 0805	ERJ-6ENF1372V	Panasonic
26	R14	1	RES, 4.7 Ω , 5%, 2 W, Wirewound, Fusible	FW20A4R70JA	Bourns
27	R15	1	RES, 360 k Ω , 5%, 1/4 W, Thick Film, 1206	ERJ-8GEYJ364V	Panasonic
28	R16	1	RES, 360 k Ω , 5%, 1/4 W, Thick Film, 1206	ERJ-8GEYJ364V	Panasonic
29	RV1	1	150 V, 7.5 J, 5 mm, RADIAL	S05K150E2	Epcos
30	T1	1	Bobbin, EE10, Vertical, 8 pins (10.2 mm W x 10.4 mm L x 9.7 mm H)	EE-1016	Yulongxin
31	T2	1	Bobbin, EE10, Vertical, 8 pins (10.2 mm W x 10.4 mm L x 9.7 mm H)	EE-1016	Yulongxin
32	U1	1	LYTSwitch-1, Wide Range, 12 W, 45V-65V, SO-8	LYT1604D	Power Integrations
33	U2	1	LYTSwitch-1, Wide Range, 12 W, 45V-65V, SO-8	LYT1604D	Power Integrations

Miscellaneous

1	L	1	Test Point, BLK, Miniature THRU-HOLE MOUNT	5001	Keystone
2	N	1	Test Point, WHT, Miniature THRU-HOLE MOUNT	5002	Keystone
3	V1+	1	Test Point, RED, Miniature THRU-HOLE MOUNT	5000	Keystone
4	V1-	1	Test Point, BLK, Miniature THRU-HOLE MOUNT	5001	Keystone
5	V2+	1	Test Point, RED, Miniature THRU-HOLE MOUNT	5000	Keystone
6	V2-	1	Test Point, BLK, Miniature THRU-HOLE MOUNT	5001	Keystone

7 Inductor Specification

7.1 Electrical Diagram

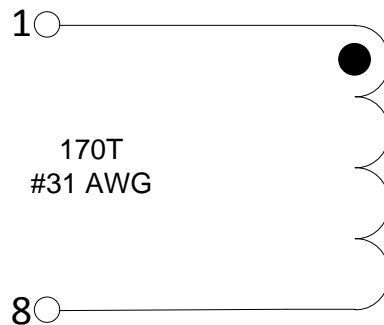

Figure 8 – Inductor Electrical Diagram.

7.2 Electrical Specifications

Parameter	Condition	Spec.
Nominal Primary Inductance	Measured at 1 V _{PK-PK} , 100 kHz switching frequency, between pin 1 and pin 8, with all other windings open.	640 μH
Tolerance	Tolerance of Primary Inductance.	±5%

7.3 Material List

Item	Description
[1]	Core: EE10.
[2]	Bobbin: EE10, Vertical, 8 pins, Part no. 25-01068-00.
[3]	Magnet Wire: #31 AWG.
[4]	Polyester Tape: 7.0 mm.
[5]	Transformer Tape: 4.5 mm.

7.4 Inductor Build Diagram

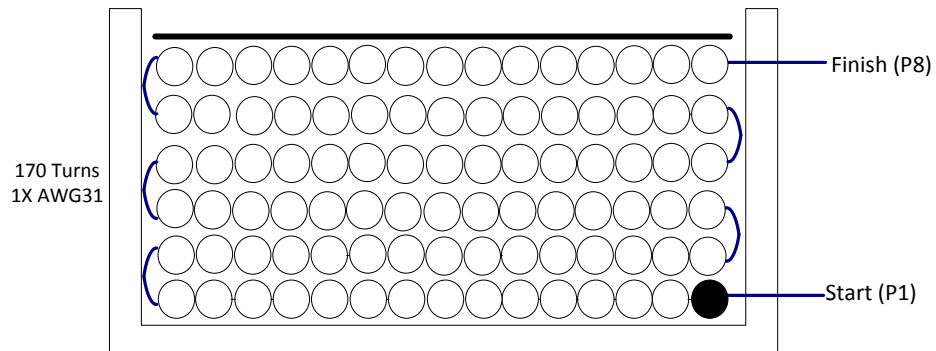

Figure 9 – Transformer Build Diagram.

7.5 Inductor Construction

Winding Directions	Bobbin is oriented on winder jig such that terminal pin 1-4 is in the left side. The winding direction is clockwise as shown in the figure.
Winding 1	Use wire item [3], start at pin 1 and wind 170 turns, then finish the winding on pin 8.
Insulation	Add 2 layer of tape, item [4], for insulation.
Terminal Pins	Pull out terminal pins 2, 3 and 4.
Core Grinding	Grind the center leg of one core until it meets the nominal inductance of 640 μ H.
Core Assembly	Assemble the 2 cores on the bobbin with the un-gapped core place on the terminal pin side as shown in the figure. Wrap the 2 cores with polyester tape item (5).
Finish	Dip the transformer assembly in 2:1 thinner and varnish solution.

7.6 Winding Illustrations

Winding Directions

Bobbin is oriented on winder jig such that terminal Pins are in the Left side. The winding direction is clockwise as shown in the figure.

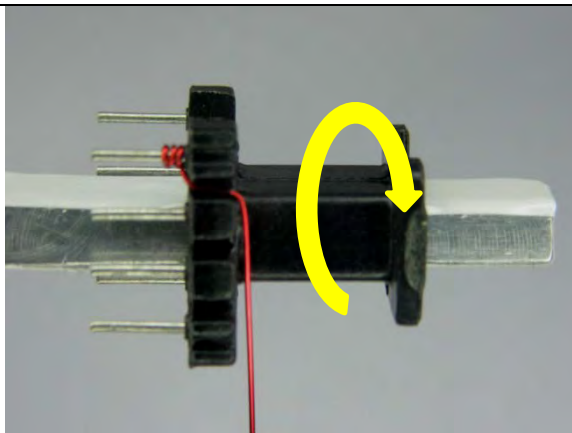

Winding 1

Use wire item [3], start at pin 1 and wind 170 turns, then finish the winding on pin 8.

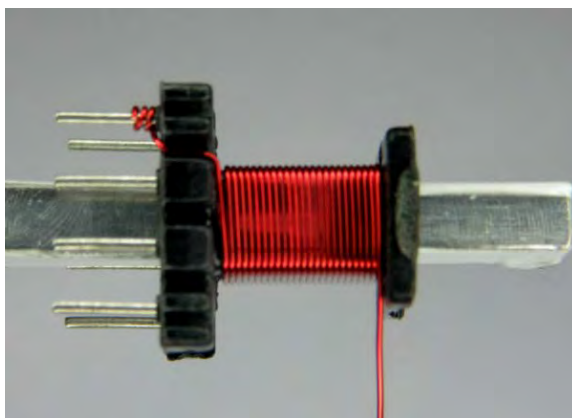

Insulation

Add 2 layer of tape, item [4], for insulation.

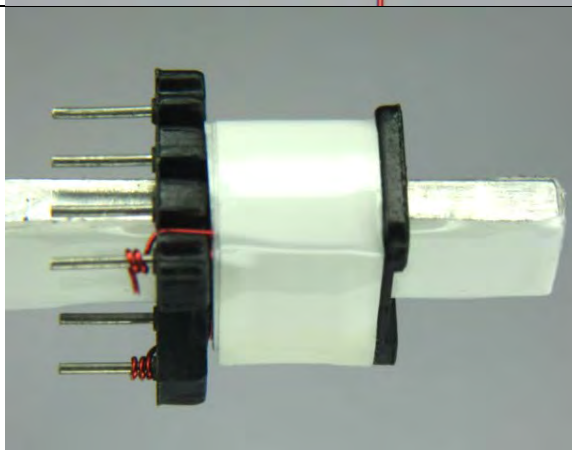

Terminal Pins

Pull out terminal pins 2-3-4.



Core Grinding

Grind the center leg of one core until it meets the nominal inductance of 640 μ H.

Core Assembly

Assemble the 2 cores on the bobbin with the un-gapped core place on the terminal pin side as shown in the figure.

Wrap the 2 cores with polyester tape Item (5). See figure on the right side.

Finish

Dip the transformer assembly in 2:1 thinner and Varnish solution.

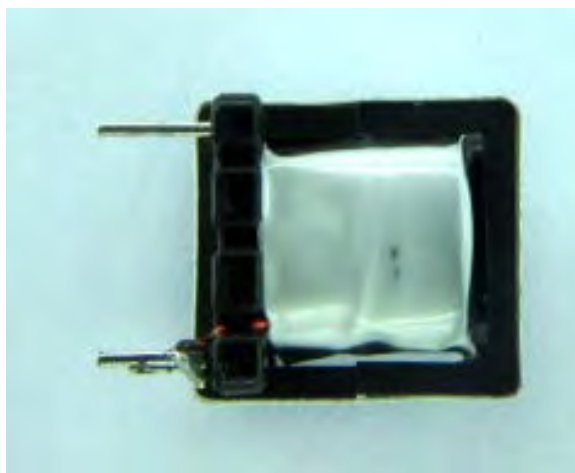
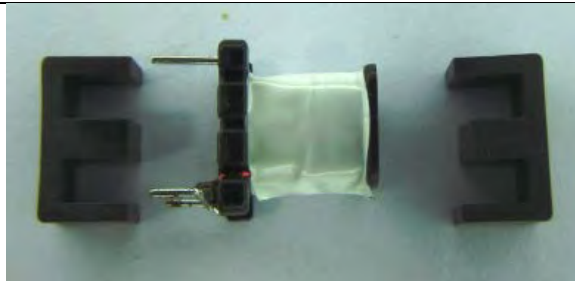

8 Inductor Design Spreadsheet

ACDC_LYTSwitch1_ Buck_031816; Rev.0.1; Copyright Power Integrations 2016	INPUT	INFO	OUTPUT	UNIT	LYTSwitch-1 Buck Design Spreadsheet
ENTER APPLICATION VARIABLES					
LINE VOLTAGE RANGE			Low Line		AC line voltage range
VACMIN	90.00		90.00	Volts AC	Minimum AC line voltage
VACTYP			115.00	Volts AC	Typical AC line voltage
VACMAX	132.00		132.00	Volts AC	Maximum AC line voltage
fL	60.00		60.00	Hz	AC mains frequency
VO	60.00		60.00	Volts DC	Worst case normal operating output voltage
IO	0.260		0.260	Amperes	Average output current specification
EFFICIENCY	0.90		0.90		Efficiency estimate
PO			15.60	Watts	Continuous output power
VD	0.70		0.70	Volts DC	Output diode forward voltage drop
OPTIMIZATION PARAMETER	THD		THD		Parameter to be optimized
ENTER LYTSWITCH-1 VARIABLES					
DEVICE BREAKDOWN VOLTAGE	725		725	Volts DC	Choose between 650V and 725V
GENERIC DEVICE	Auto		LYT1XX4D		Generic LYTSwitch-1 device based on power
DEVICE CODE			LYT1604D		Actual LYTSwitch-1 device code
ILIMITMIN			1.59	Amperes	Minimum Current Limit
ILIMITTYP			1.71	Amperes	Typical Current Limit
ILIMITMAX			1.82	Amperes	Maximum Current Limit
TON			6.51	us	On-time during the fixed on-time region at VACTYP
FSW			63.21	kHz	Maximum switching frequency in the fixed current limit region at VACTYP
DMAX			0.79		Maximum duty cycle possible in the fixed on-time region
ENTER INDUCTOR CORE/CONSTRUCTION VARIABLES					
CORE	EE10		EE10		Enter Transformer Core
CUSTOM CORE NAME					If custom core is used - Enter part number here
AE			12.10	mm ²	Core effective cross sectional area
LE			26.10	mm	Core effective path length
AL			850.00	nH/turn ²	Core ungapped effective inductance
AW			11.88	mm ²	Window Area of the bobbin
BW			6.60	mm	Bobbin physical winding width
MARGIN			0.00	mm	Safety Margin Width (Half the Primary to Secondary Creepage Distance)
LAYERS			6		Number of Layers
INDUCTOR DESIGN PARAMETERS					
LP_MIN_ABSOLUTE			131	uH	Absolute minimum design inductance
LP_TYP	640		640	uH	Typical design inductance
LP_TOLERANCE			5	%	Tolerance of the design inductance
LP_MAX			1282	uH	Absolute maximum design inductance
TURNS	170		170	Turns	Number of inductor turns
ALG			22.15	nH/turn ²	Inductance per turns squared
BMAX			3700	Gauss	Operating maximum flux density in the fixed peak current region
BMAX_ACTUAL			3669	Gauss	Actual saturation flux density in the fixed peak current region
BAC			1850	Gauss	AC flux density in the fixed peak current region
LG			0.669	mm	Core air gap
BWE			39.60	mm	Effective bobbin width
OD			0.233	mm	Outer diameter of the wire with insulation
INS			0.046	mm	Wire insulation
DIA			0.187	mm	Outer diameter of the wire without insulation
AWG	31		31		AWG of the bare wire.
CM			81	Cmils	Bare wire circular mils



CMA			218.3	Cmils/A	Bare wire circular mils per ampere
CURRENT DENSITY			8.7	A/mm ²	Bare wire current density
BOBBIN FILL FACTOR			77.65%		Area of the bobbin occupied by wire
CURRENT WAVEFORM SHAPE PARAMETERS					
I AVERAGE_INDUCTOR			0.251	Amperes	Average inductor current at VACTYP obtained from half-line cycle emulation
I PEAK_MOSFET			0.936	Amperes	MOSFET peak current at VACTYP when operating in the current limit region
I RMS_MOSFET			0.239	Amperes	MOSFET RMS current at VACTYP obtained from half-line cycle emulation
I RMS_DIODE			0.282	Amperes	Diode RMS current at VACTYP obtained from half-line cycle emulation
I RMS_INDUCTOR			0.369	Amperes	Inductor RMS current at VACTYP obtained from half-line cycle emulation
LYTSWITCH EXTERNAL COMPONENTS					
FB Pin Resistor					
RFB (Non standard value)			0.321	Ohms	Non standard value of the feedback pin sense resistor
RFB (Standard 1% Value)			0.324	Ohms	Standard 1% value of the feedback pin sense resistor
M Pin Resistor					
R UPPER (Standard 1% Value)			402.00	kOhms	Standard 1% value of the upper (fixed) resistor on the M-pin divider network
R LOWER (Non standard value)			13.86	kOhms	Non standard value of the lower resistor on the M-pin divider network
R LOWER (Standard 1% Value)			14.00	kOhms	Standard 1% value of the lower resistor on the M-pin divider network
LOAD OVERVOLTAGE THRESHOLD			71.314	Volts DC	Load overvoltage threshold
VOLTAGE STRESS PARAMETERS					
VDRAIN			186.68	Volts DC	Estimated worst case drain voltage
PIVD			186.68	Volts DC	Output Rectifier Maximum Peak Inverse Voltage

9 Performance Data

All measurements were performed at room temperature using LED loads string. 1 minute soak time was applied before measurement with AC source turned-off for 5 seconds every succeeding input line measurement.

9.1 Efficiency

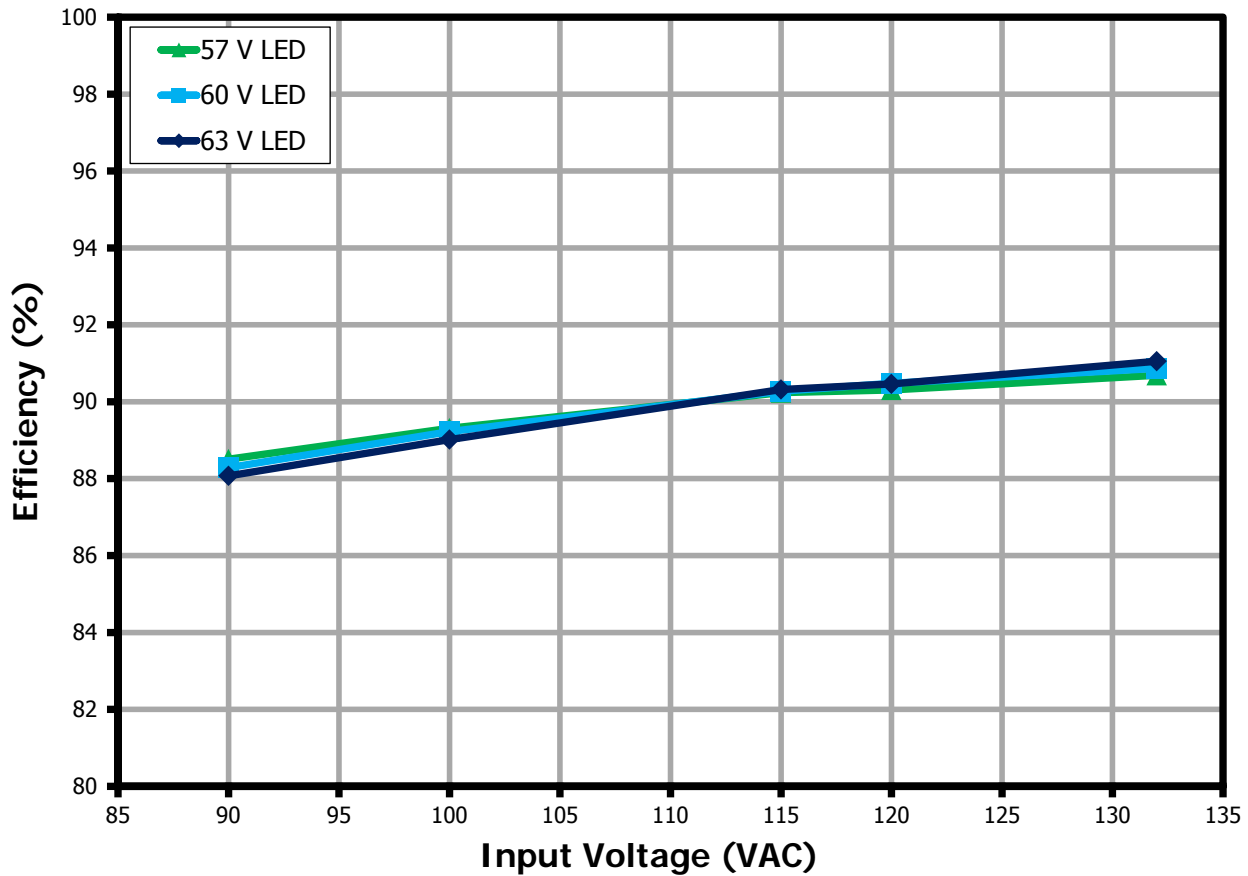

Figure 10 – Efficiency vs. Line and LED Load.

9.2 Line Regulation

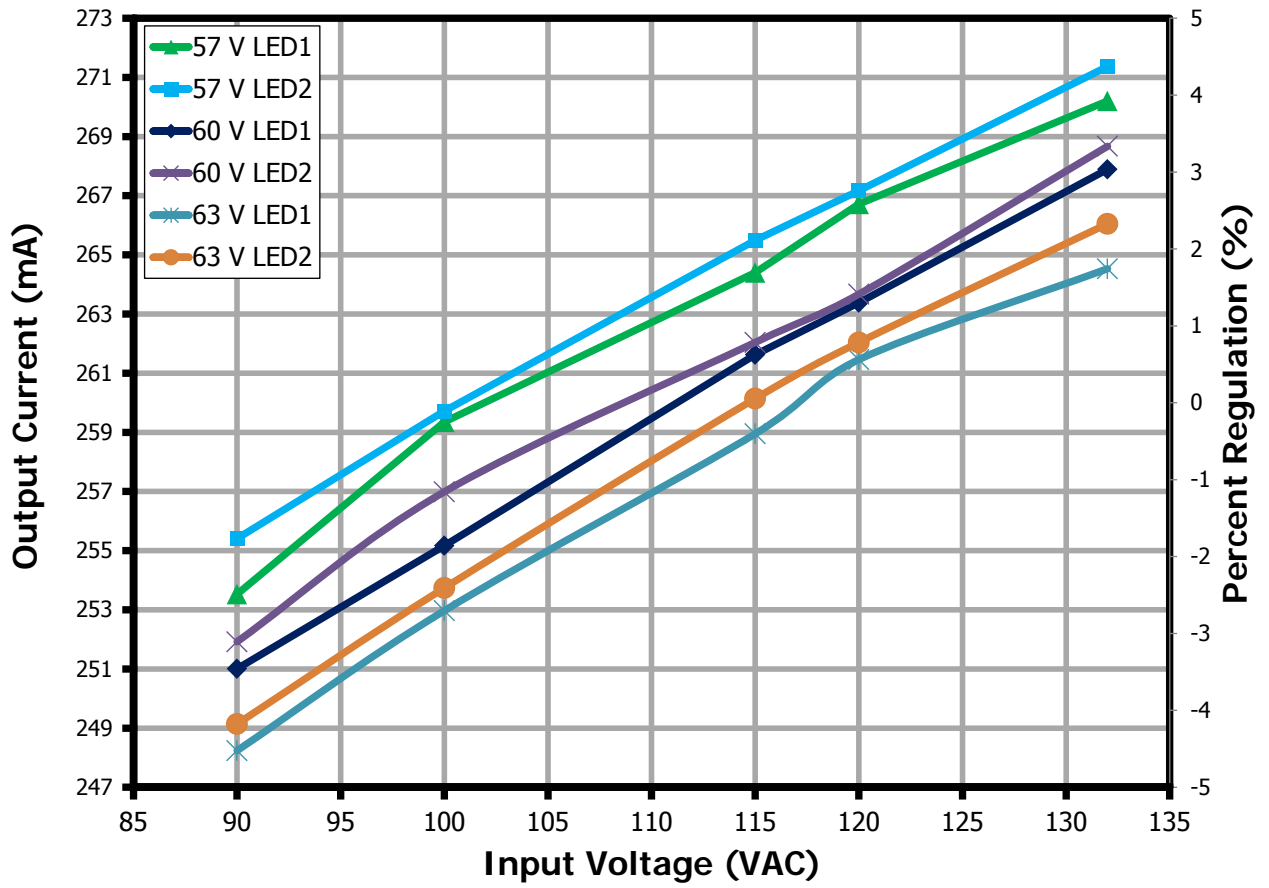

Figure 11 – Regulation vs. Line and LED Load.



9.3 Power Factor

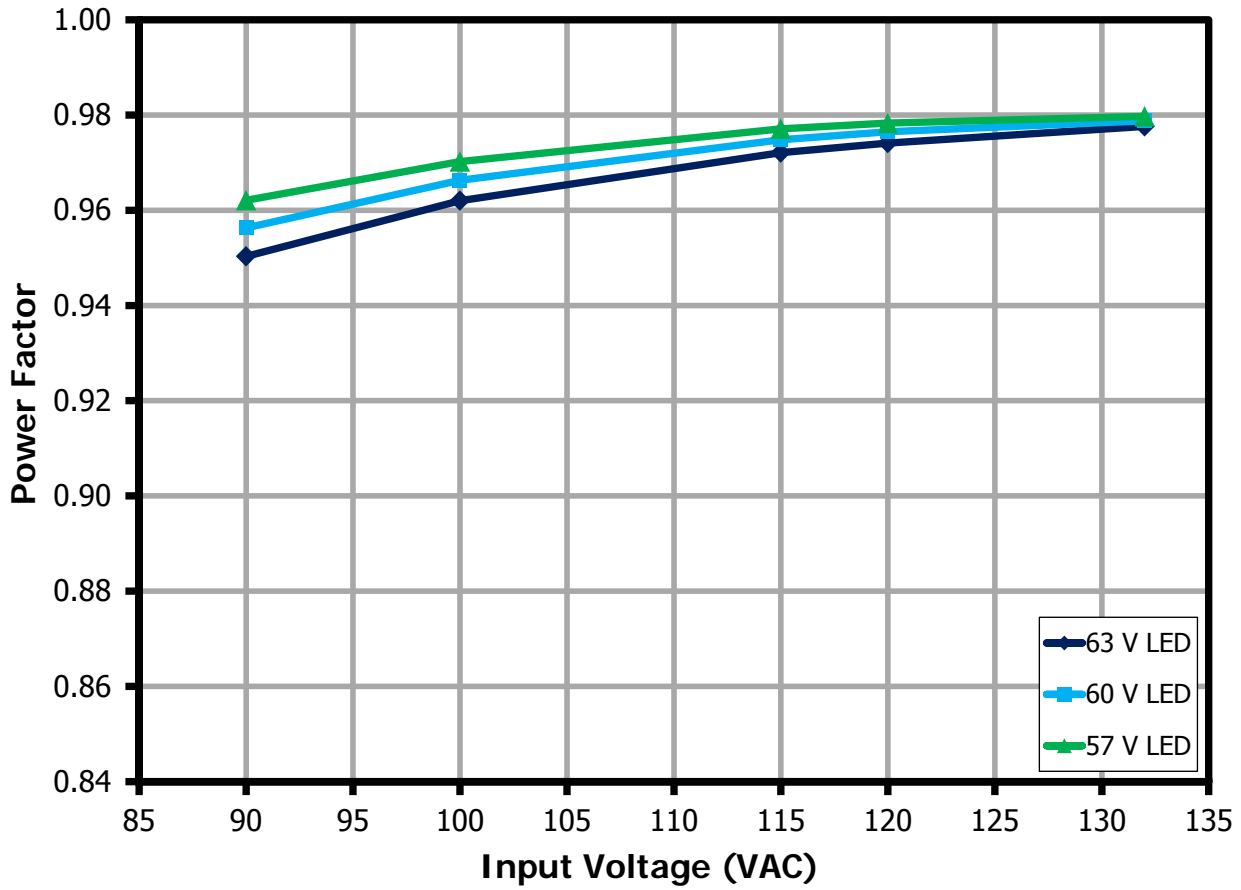

Figure 12 – Power Factor vs. Line and LED Load.

9.4 %ATHD

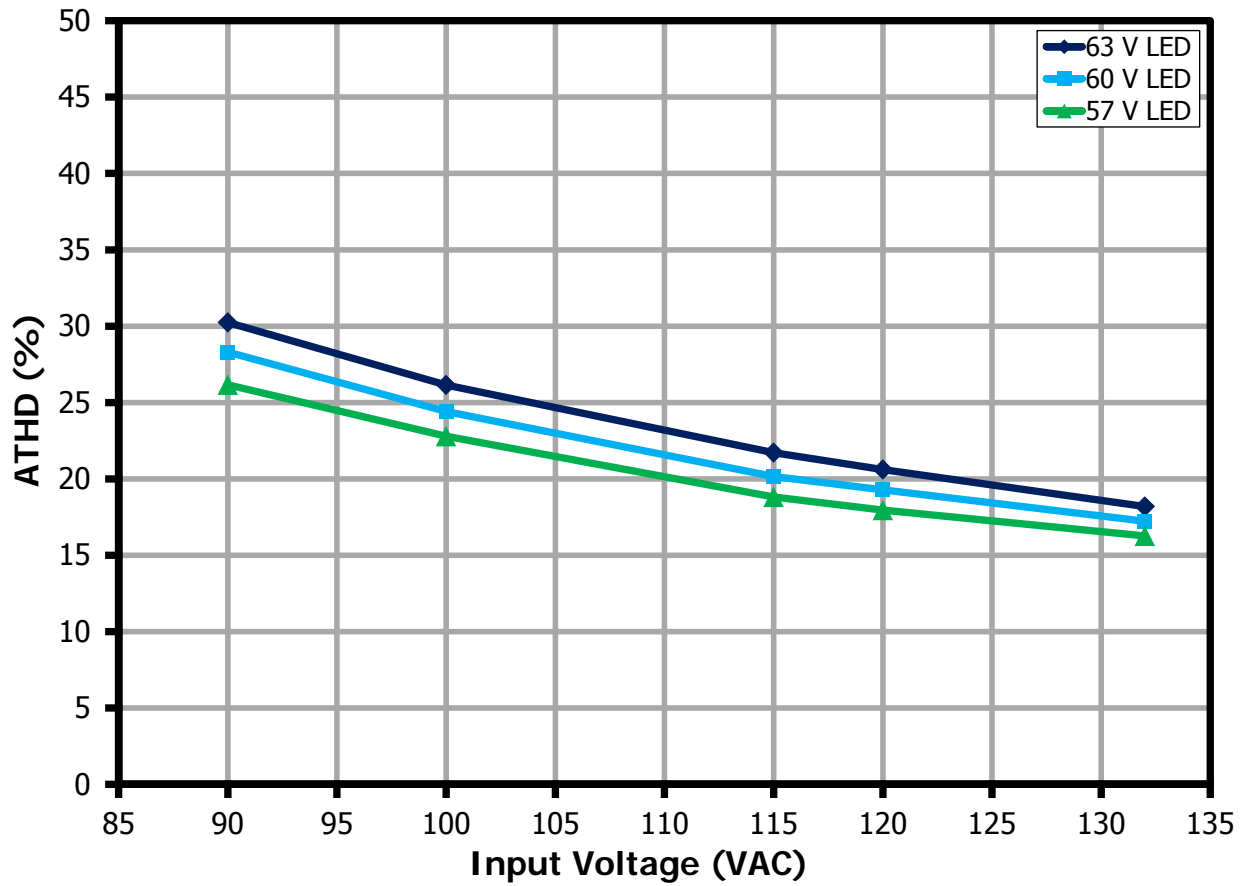

Figure 13 – %ATHD vs. Line and LED Load.



10 Test Data

10.1 Test Data, 57 V LED Loads

Input		Input Measurement					LED Load1 Measurement			LED Load2 Measurement			P _{OUT} Total	Efficiency (%)
VAC (V _{RMS})	Freq (Hz)	V _{IN} (V _{RMS})	I _{IN} (mA _{RMS})	P _{IN} (W)	PF	%ATHD	V _{OUT1} (V _{DC})	I _{OUT1} (mA _{DC})	P _{OUT1} (W)	V _{OUT2} (V _{DC})	I _{OUT2} (mA _{DC})	P _{OUT2} (W)		
90	60	89.96	371.91	32.19	0.962	26.17	55.65	253.53	14.17	55.80	255.41	14.32	28.49	88.51
100	60	99.90	336.76	32.64	0.970	22.79	55.87	259.35	14.55	55.96	259.72	14.60	29.15	89.31
115	60	114.98	294.43	33.08	0.977	18.82	56.04	264.40	14.88	56.16	265.49	14.97	29.85	90.24
120	60	119.95	284.07	33.33	0.978	17.96	56.11	266.72	15.03	56.21	267.17	15.08	30.10	90.31
132	60	131.93	261.07	33.75	0.980	16.27	56.23	270.20	15.25	56.36	271.37	15.35	30.60	90.69

10.2 Test Data, 60 V LED Loads

Input		Input Measurement					LED Load1 Measurement			LED Load2 Measurement			P _{OUT} Total	Efficiency (%)
VAC (V _{RMS})	Freq (Hz)	V _{IN} (V _{RMS})	I _{IN} (mA _{RMS})	P _{IN} (W)	PF	%ATHD	V _{OUT1} (V _{DC})	I _{OUT1} (mA _{DC})	P _{OUT1} (W)	V _{OUT2} (V _{DC})	I _{OUT2} (mA _{DC})	P _{OUT2} (W)		
90	60	89.97	391.92	33.72	0.956	28.30	58.90	251.01	14.85	58.98	251.92	14.92	29.77	88.29
100	60	99.90	352.89	34.07	0.966	24.42	59.05	255.17	15.13	59.17	256.99	15.27	30.40	89.22
115	60	114.98	308.23	34.55	0.975	20.15	59.30	261.62	15.57	59.35	262.04	15.61	31.19	90.27
120	60	119.95	296.35	34.71	0.977	19.28	59.35	263.38	15.69	59.40	263.67	15.72	31.41	90.48
132	60	131.93	273.26	35.29	0.979	17.23	59.52	267.89	16.00	59.58	268.67	16.06	32.06	90.87

10.3 Test Data, 63 V LED Loads

Input		Input Measurement					LED Load1 Measurement			LED Load2 Measurement			P _{OUT} Total	Efficiency (%)
VAC (V _{RMS})	Freq (Hz)	V _{IN} (V _{RMS})	I _{IN} (mA _{RMS})	P _{IN} (W)	PF	%ATHD	V _{OUT1} (V _{DC})	I _{OUT1} (mA _{DC})	P _{OUT1} (W)	V _{OUT2} (V _{DC})	I _{OUT2} (mA _{DC})	P _{OUT2} (W)		
90	60	89.96	410.43	35.09	0.950	30.25	61.81	248.24	15.41	61.96	249.14	15.50	30.91	88.07
100	60	99.90	369.08	35.47	0.962	26.15	62.00	252.97	15.74	62.15	253.74	15.83	31.57	89.02
115	60	114.98	321.89	35.98	0.972	21.72	62.33	258.95	16.20	62.42	260.14	16.30	32.49	90.32
120	60	119.95	310.37	36.27	0.974	20.61	62.42	261.46	16.38	62.48	262.04	16.43	32.81	90.46
132	60	131.93	283.72	36.59	0.978	18.19	62.55	264.53	16.60	62.64	266.05	16.72	33.32	91.06



11 Thermal Performance

11.1 Thermal Performance Scan – Open Frame Unit

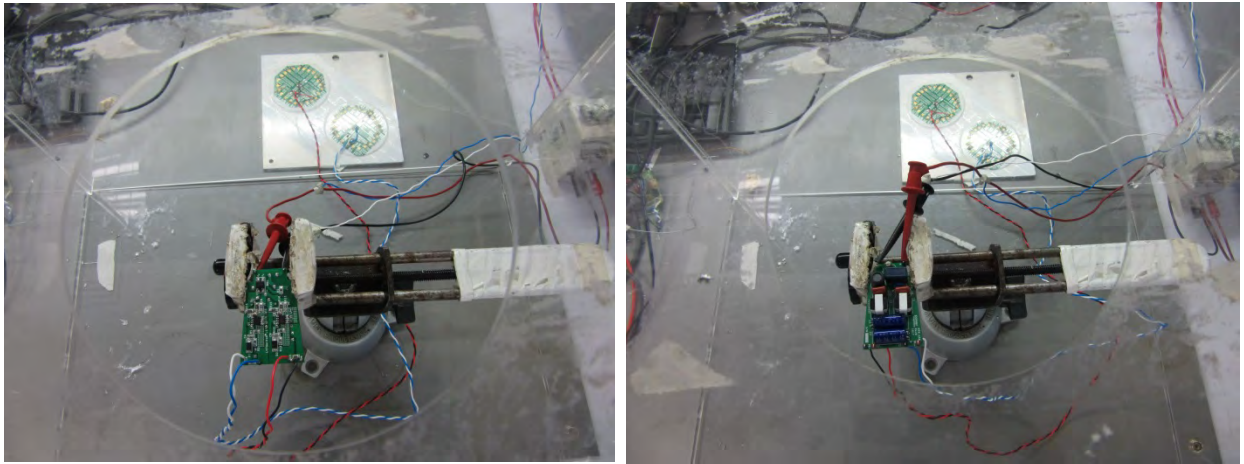

Figure 14 – Test Set-up Picture - Open Frame.

Unit in open frame was placed inside the acrylic enclosure to prevent airflow that might affect the thermal measurements. Temperature was measured using FLIR thermal camera. The ambient temperature is 30 °C.

11.1.1 Thermal Scan at Normal Operation 115 V, 60 V LED Loads

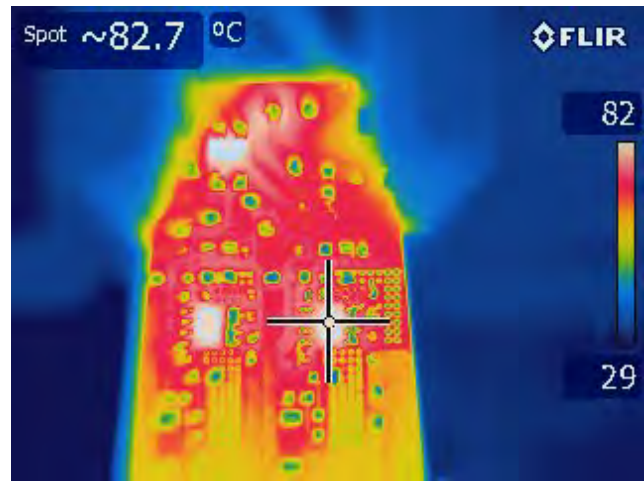
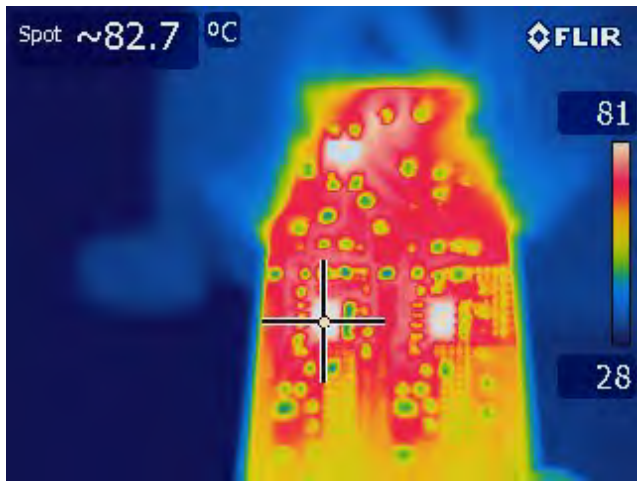

Figure 15 – 115 VAC, 60 V LED Loads.
Spot 1: LYT1604D (U1): 82.7 °C.

Figure 16 – 115 VAC, 60 V LED Loads.
Spot 1: LYT1604D (U2): 82.7 °C.

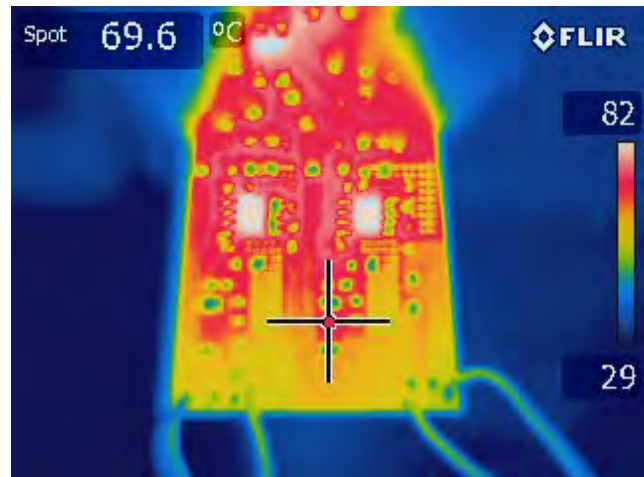
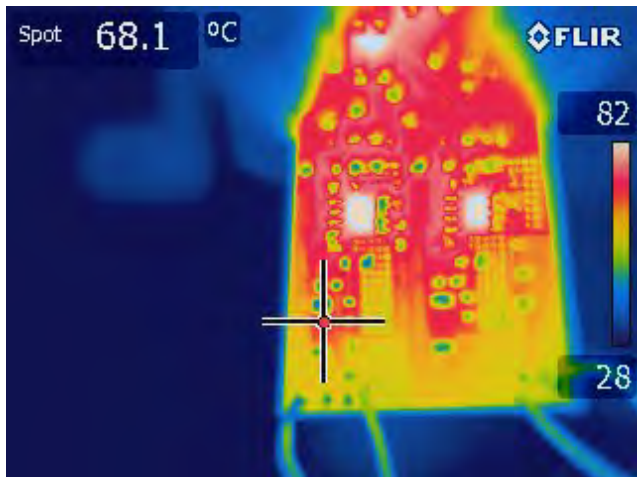

Figure 17 – 115 VAC, 60 V LED Loads.
Spot 1: Flywheel Diode (D1): 68.1 °C.

Figure 18 – 115 VAC, 60 V LED Loads.
Spot 1: Flywheel Diode (D2): 69.6 °C.

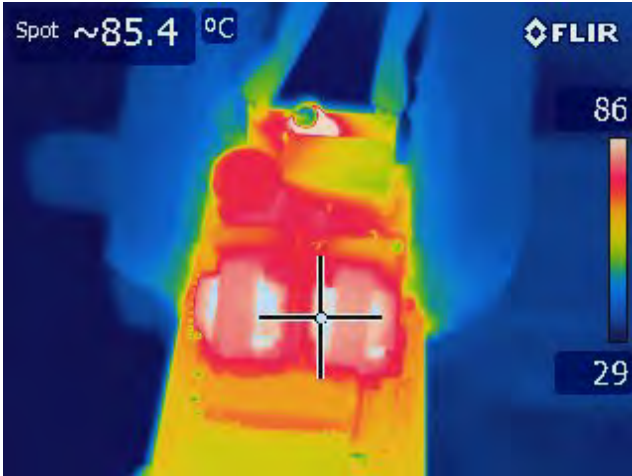

Figure 19 – 115 VAC, 60 V LED Loads.
Spot 1: Buck Inductor (T1): 85.4 °C.

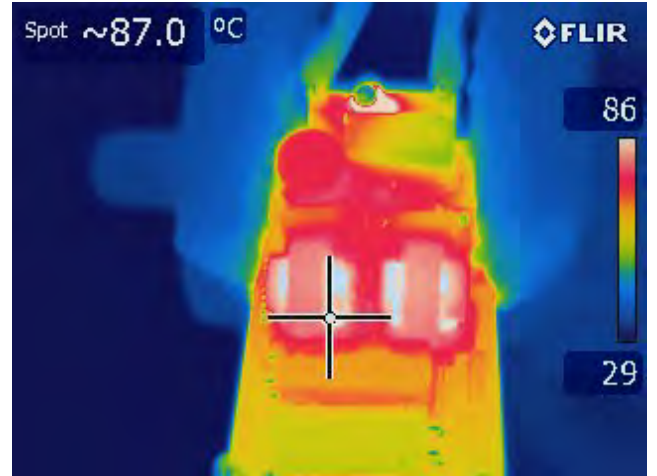

Figure 20 – 115 VAC, 60 V LED Loads.
Spot 1: Buck Inductor (T2): 87.0 °C.

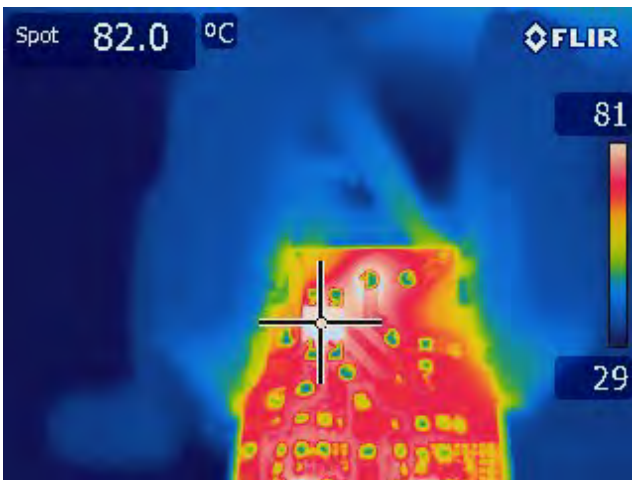

Figure 21 – 115 VAC, 60 V LED Loads.
Spot 1: Bridge Diode (BR1): 82.0 °C.

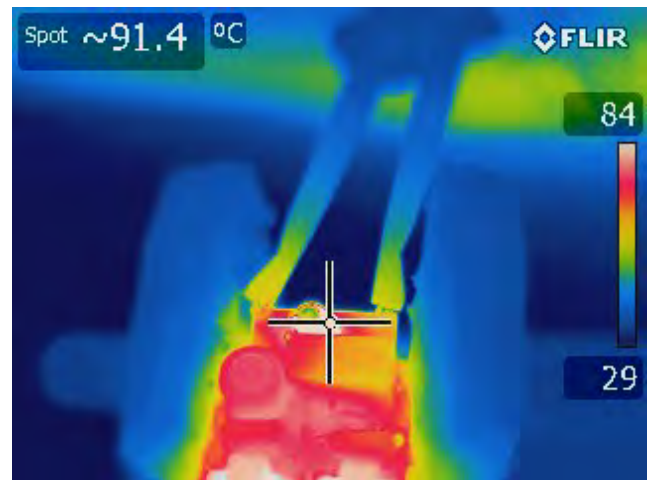

Figure 22 – 115 VAC, 60 V LED Loads.
Spot 1: Fusible Resistor (R14): 91.4 °C.

11.1.2 Thermal Scan During Output_1 Short-Circuit at 115 VAC Input

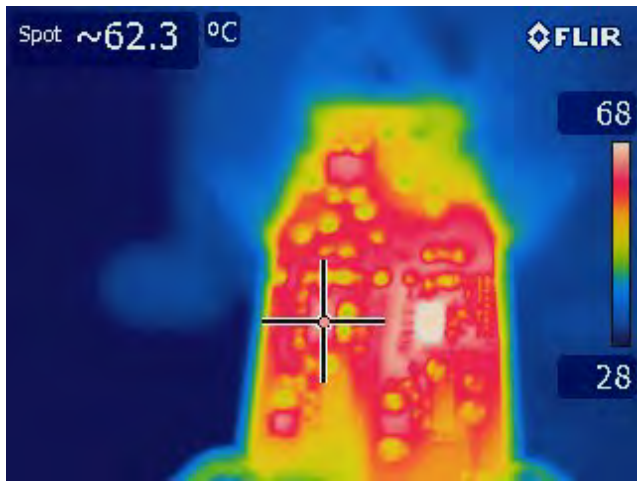

Figure 23 – 115 VAC, Output_1 Short.
Spot 1: LYT1604D (U1): 62.3 °C.

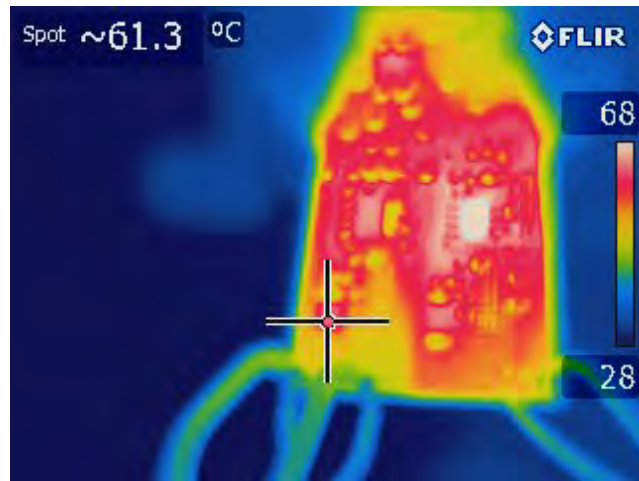

Figure 24 – 115 VAC, Output_1 Short.
Spot 1: Flywheel Diode (D1): 61.3 °C.

11.1.3 Thermal Scan During Output_2 Short-Circuit at 115 VAC Input



Figure 25 – 115 VAC, Output_2 Short.
Spot 1: LYT1604D (U2): 64.2 °C.



Figure 26 – 115 VAC, Output_2 Short.
Spot 1: Flywheel Diode (D2): 68.8 °C.

11.2 Thermal Performance Inside Chamber – Open Frame Unit

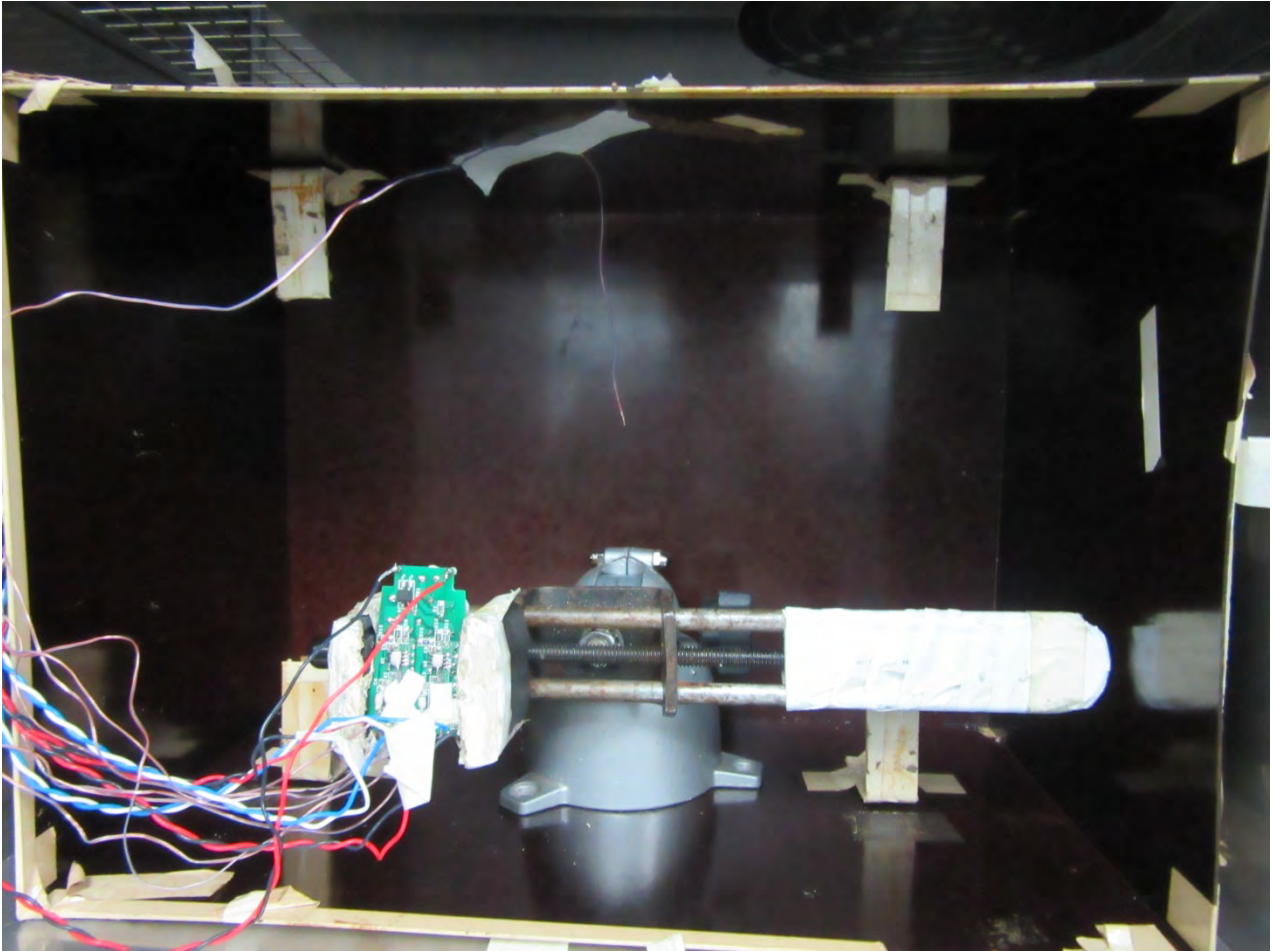

Figure 27 – Test Set-up Picture Thermal at 85 °C Ambient - Open Frame.

Unit in open frame was placed inside the enclosure to prevent airflow that might affect the thermal measurements. Ambient temperature inside enclosure is 85 °C, at nominal line. Temperature was measured using type T thermocouple.

11.2.1 Thermal Performance at 115VAC with a 60 V LED Loads

Measurement	Ambient	LYTSwitch-1 #1	LYTSwitch-1 #2	D1	D2	T1	T2	R14
Maximum (°C)	86.0	128.7	127.8	108.4	112.3	128.5	126.4	132.6
Final (°C)	84.3	128.1	127.4	107.7	111.6	128.4	126.3	132

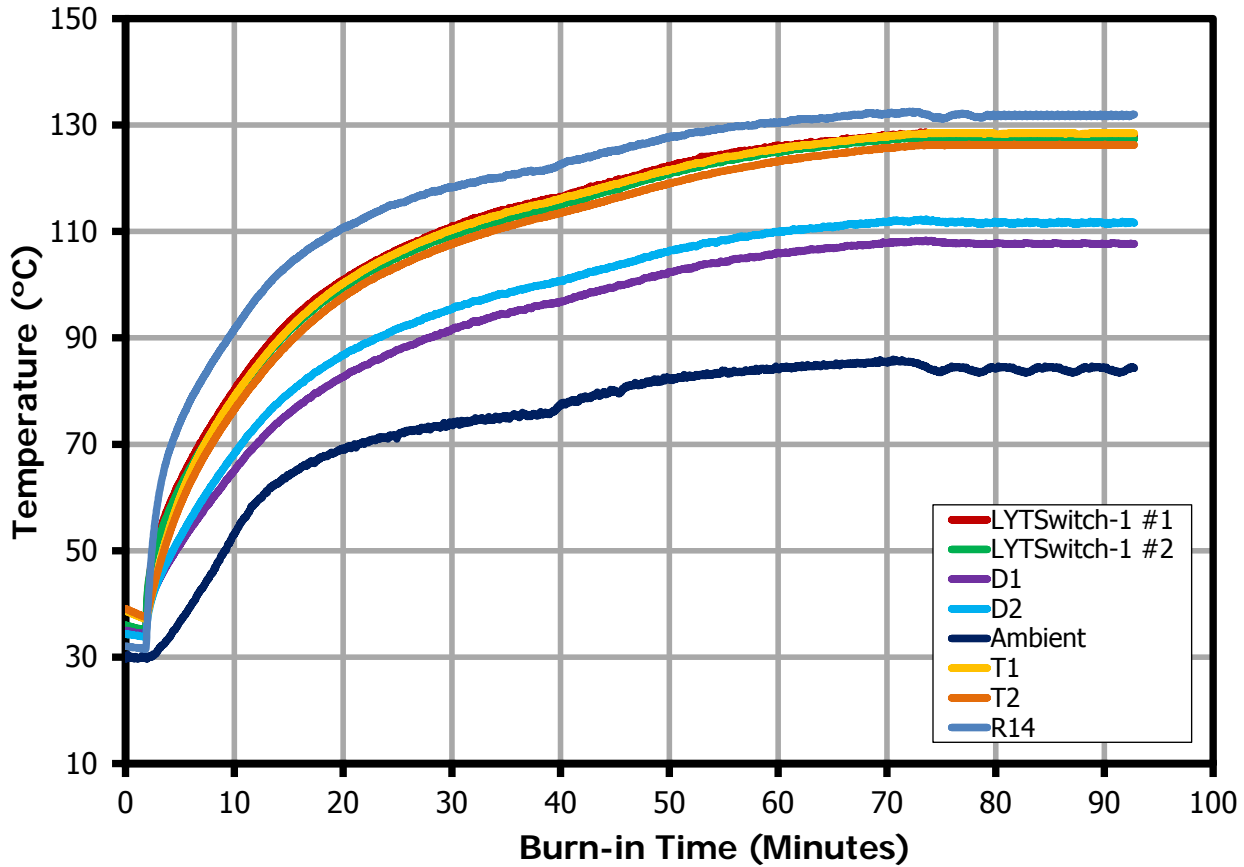

Figure 28 – Component Temperature at 115 VAC, 60 V LED Loads, 85 °C Ambient.

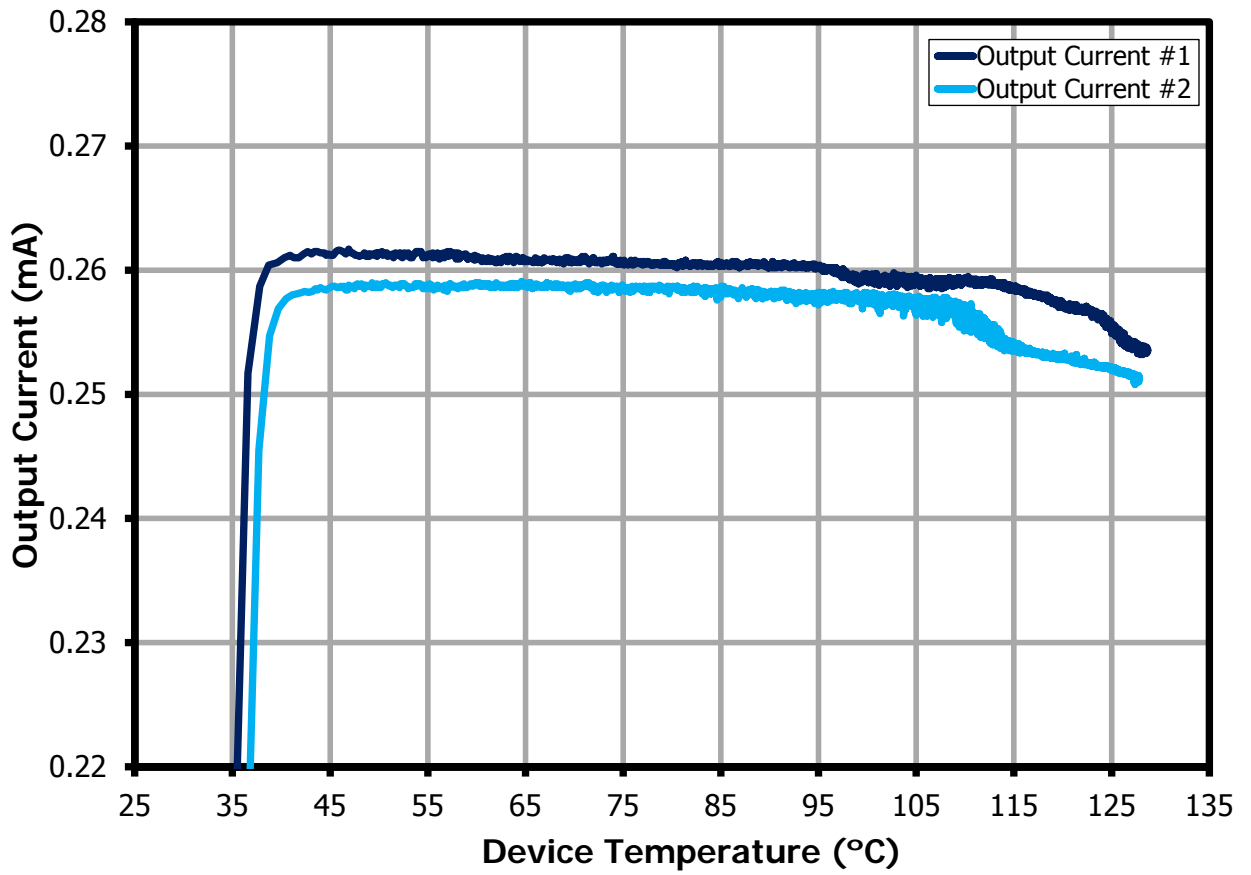

Figure 29 – Output Current vs. Device Temperature at 115 VAC, 60 V LED Loads, 85 °C Ambient.



11.2.2 Thermal Performance at 90 VAC with a 60 V LED Loads

Measurement	Ambient	LYTSwitch-1 #1	LYTSwitch-1 #2	D1	D2	T1	T2	R14
Maximum (°C)	76.5	127.2	126.0	101.3	105.7	122.3	119.9	146.7
Final (°C)	76.2	126.9	126	101	105.5	122.2	119.8	146.7

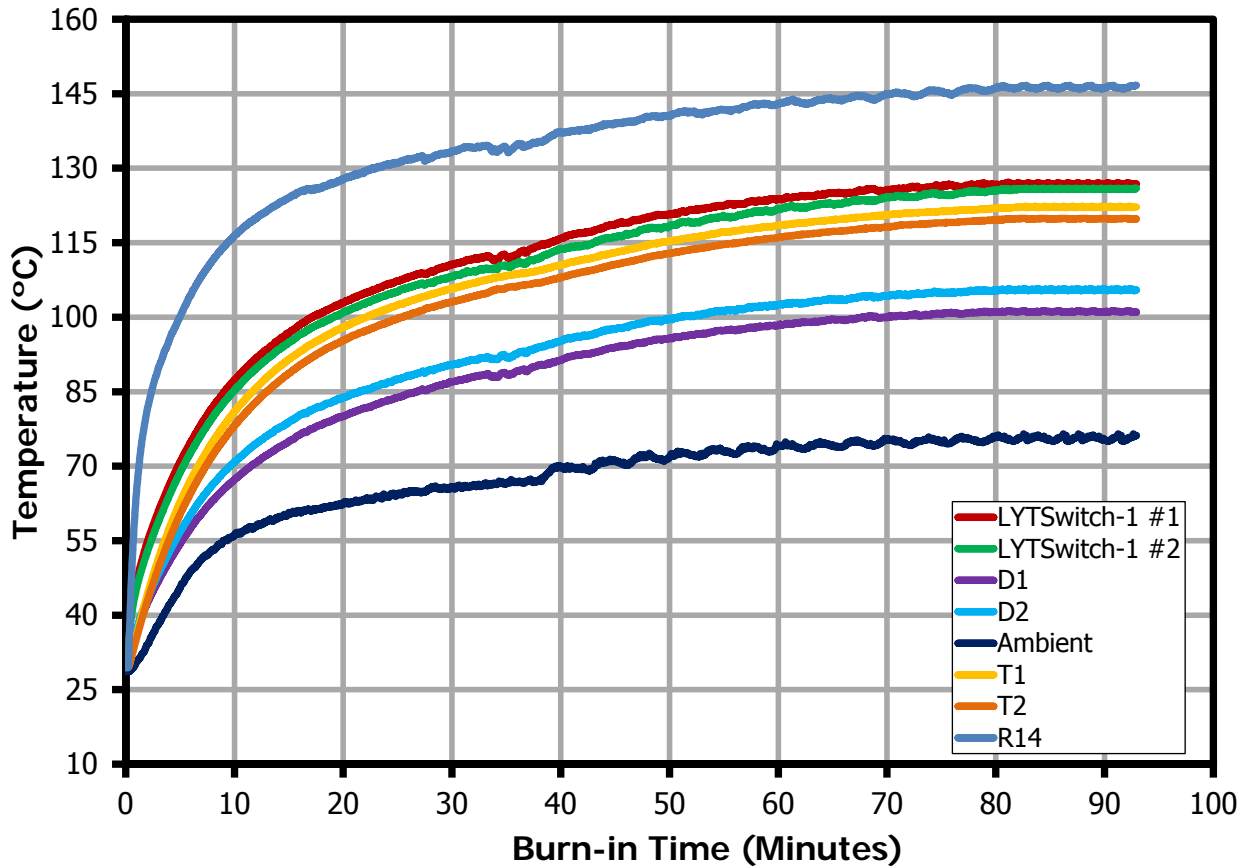

Figure 30 – Component Temperature at 90 VAC, 60 V LED Loads, 75 °C Ambient.

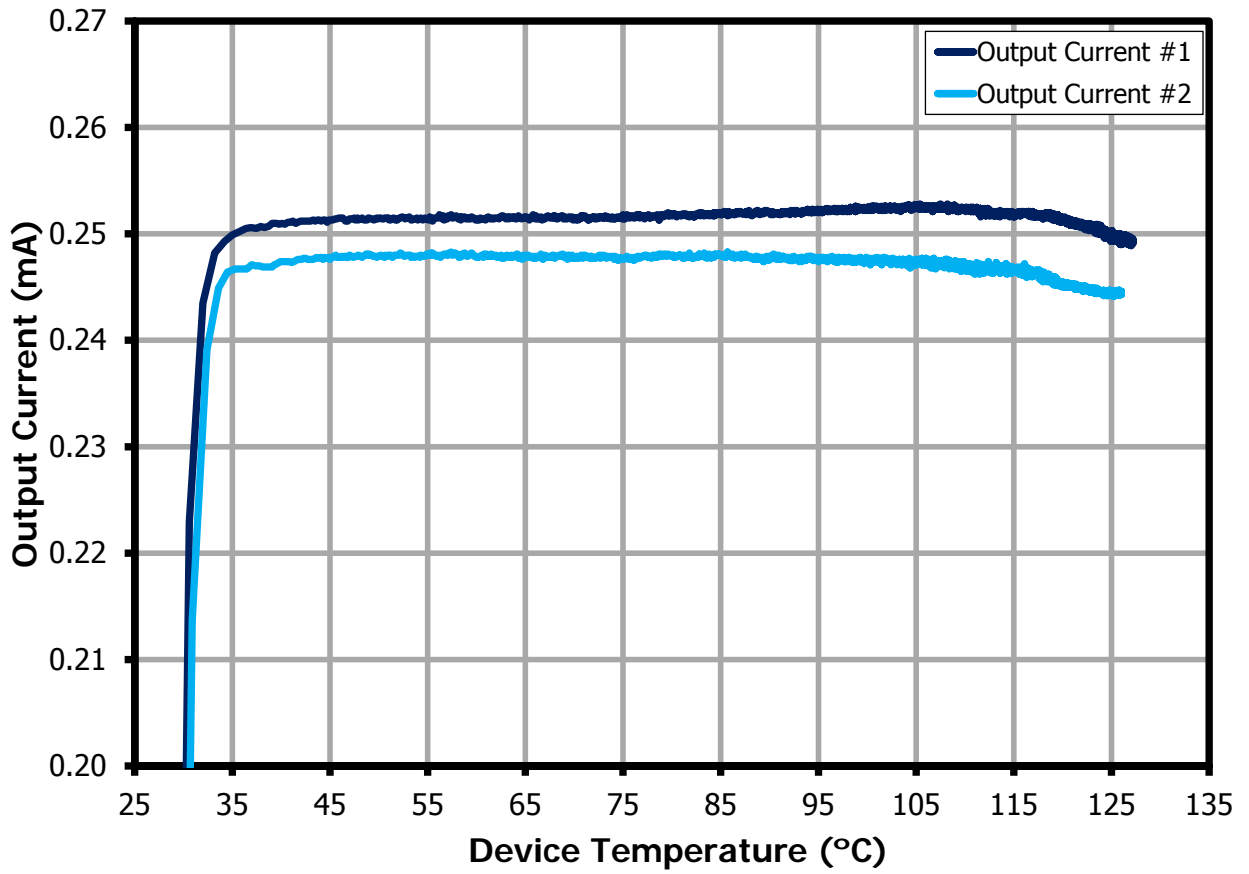

Figure 31 – Output Current vs. Device Temperature at 90 VAC, 60 V LED Loads, 75 °C Ambient.



12 Waveforms

12.1 Input Voltage and Input Current Waveforms

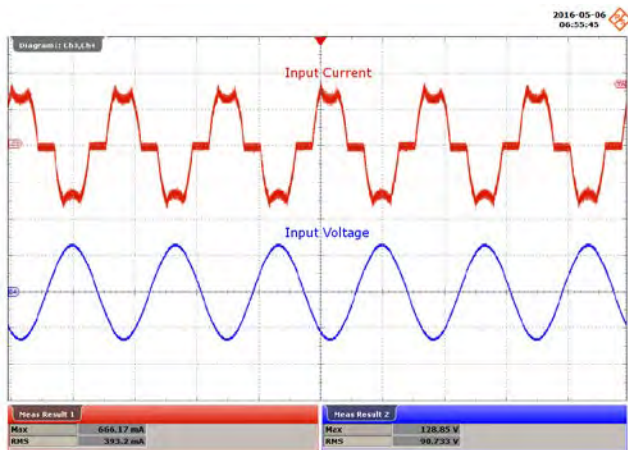

Figure 32 – 90 VAC, 60 V LED Loads.
Upper: I_{IN} , 400 mA / div.
Lower: V_{IN} , 100 V / div., 10 ms / div.

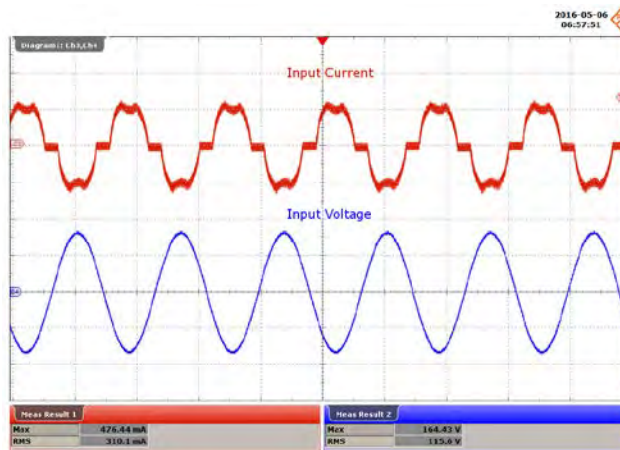

Figure 33 – 115 VAC, 60 V LED Loads.
Upper: I_{IN} , 400 mA / div.
Lower: V_{IN} , 100 V / div., 10 ms / div.

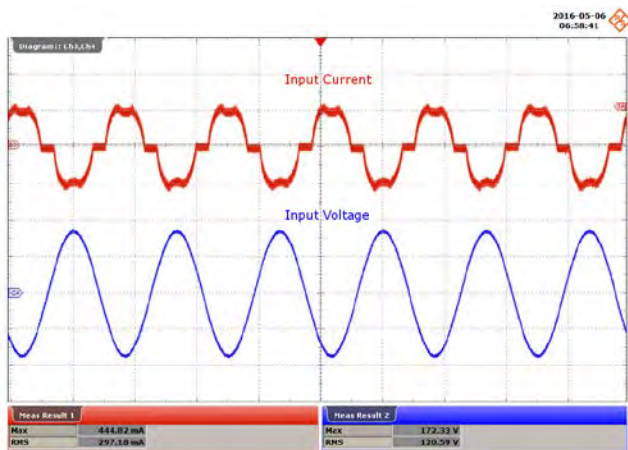

Figure 34 – 120 VAC, 60 V LED Loads.
Upper: I_{IN} , 400 mA / div.
Lower: V_{IN} , 100 V / div., 10 ms / div.

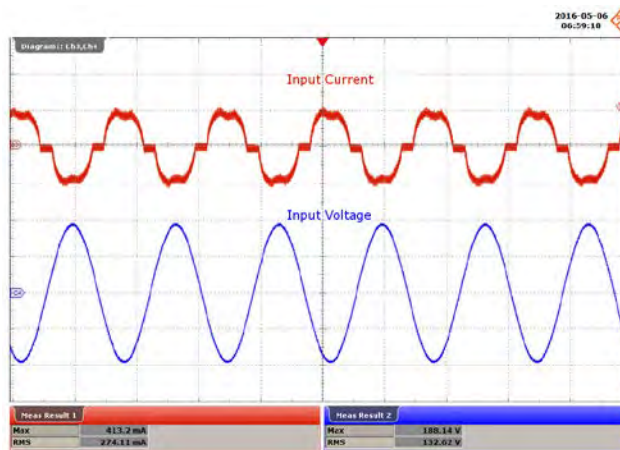

Figure 35 – 132 VAC, 60 V LED Loads.
Upper: I_{IN} , 400 mA / div.
Lower: V_{IN} , 100 V / div., 10 ms / div.

12.2 Start-up Profile

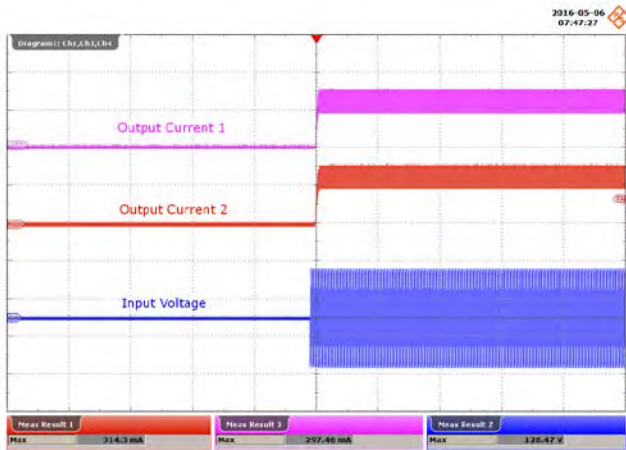

Figure 36 – 90 VAC, 60 V LEDs, Output Rise.
 Upper: I_{OUT} , 200 mA / div.
 Lower: V_{IN} , 100 V / div., 1 s / div.

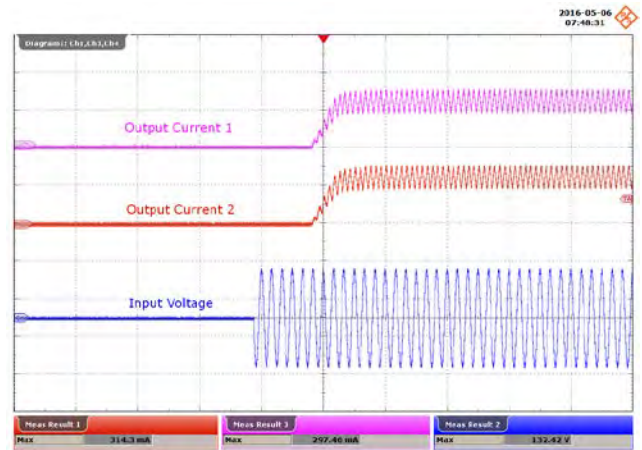

Figure 37 – 90 VAC, 60 V LEDs, Output Rise.
 Upper: I_{OUT} , 200 mA / div.
 Lower: V_{IN} , 100 V / div., 100 ms / div.

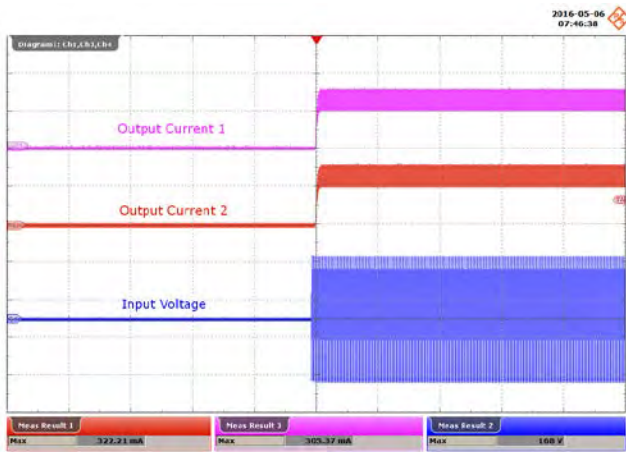

Figure 38 – 115 VAC, 60 V LEDs, Output Rise.
 Upper: I_{OUT} , 200 mA / div.
 Lower: V_{IN} , 100 V / div., 1 s / div.

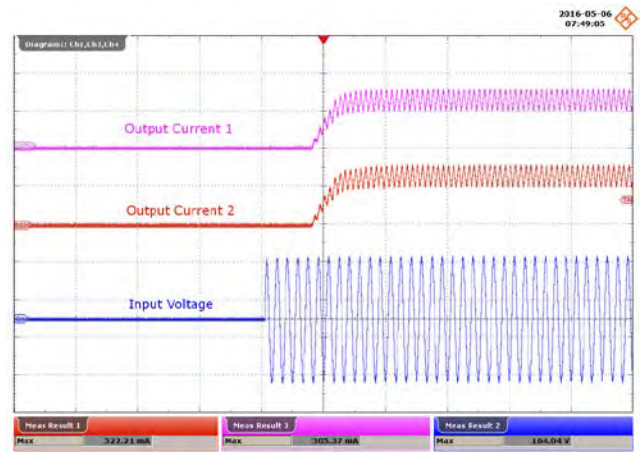

Figure 39 – 115 VAC, 60 V LEDs, Output Rise.
 Upper: I_{OUT} , 200 mA / div.
 Lower: V_{IN} , 100 V / div., 100 ms / div.



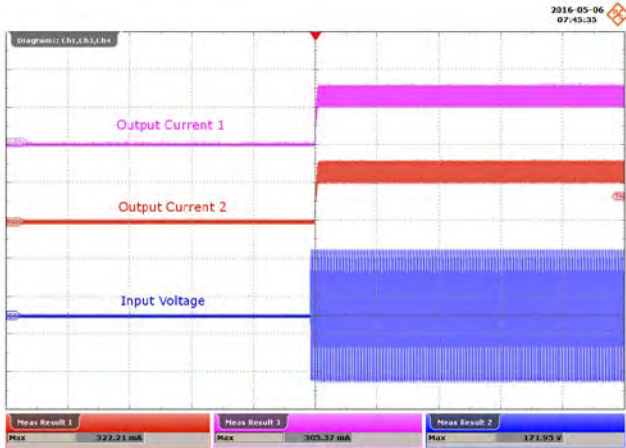

Figure 40 – 120 VAC, 60 V LEDs, Output Rise.
 Upper: I_{OUT} , 200 mA / div.
 Lower: V_{IN} , 100 V / div., 1 s / div.

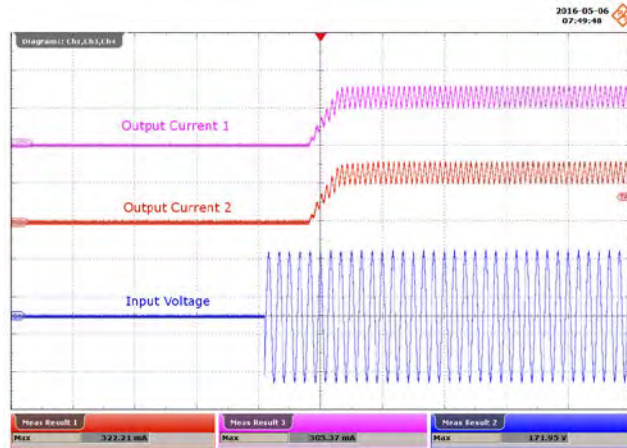

Figure 41 – 120 VAC, 60 V LEDs, Output Rise.
 Upper: I_{OUT} , 200 mA / div.
 Lower: V_{IN} , 100 V / div., 100 ms / div.

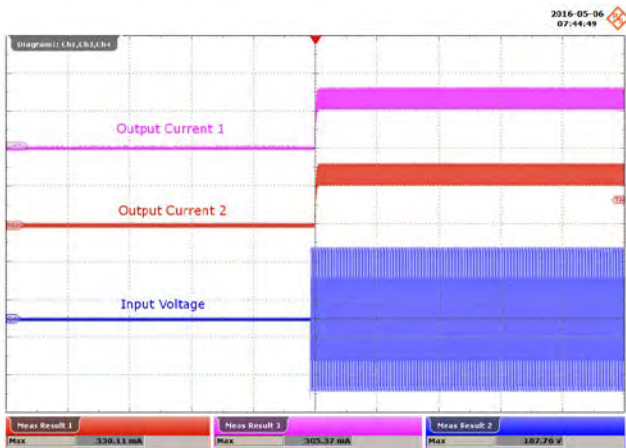

Figure 42 – 132 VAC, 60 V LEDs, Output Rise.
 Upper: I_{OUT} , 200 mA / div.
 Lower: V_{IN} , 100 V / div., 1 s / div.

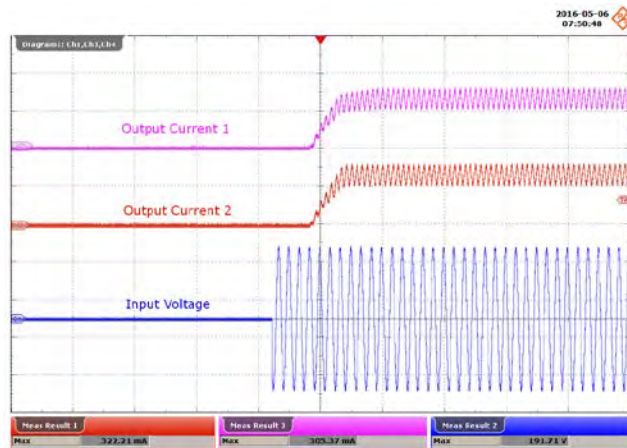

Figure 43 – 132 VAC, 60 V LEDs Load, Output Rise.
 Upper: I_{OUT} , 200 mA / div.
 Lower: V_{IN} , 100 V / div., 100 ms / div.

12.3 Output Current Fall

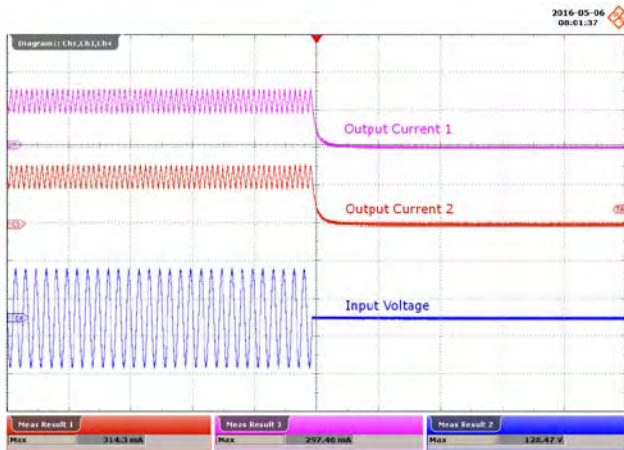

Figure 44 – 90 VAC, 60 V LEDs, Output Fall.
 Upper: I_{OUT} , 200 mA / div.
 Lower: V_{IN} , 100 V / div., 100 ms / div.

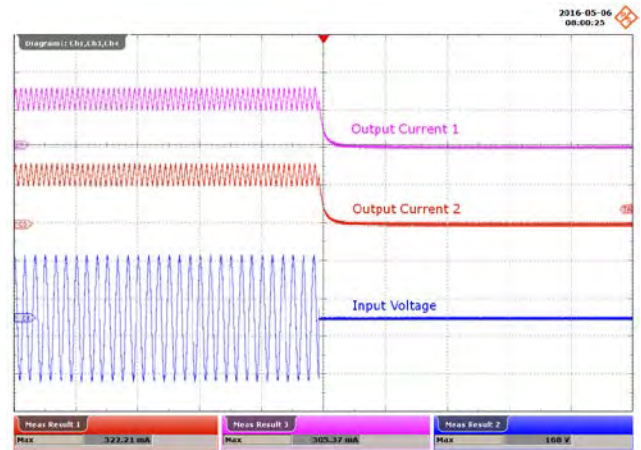

Figure 45 – 115 VAC, 60 V LEDs, Output Fall.
 Upper: I_{OUT} , 200 mA / div.
 Lower: V_{IN} , 100 V / div., 100 ms / div.

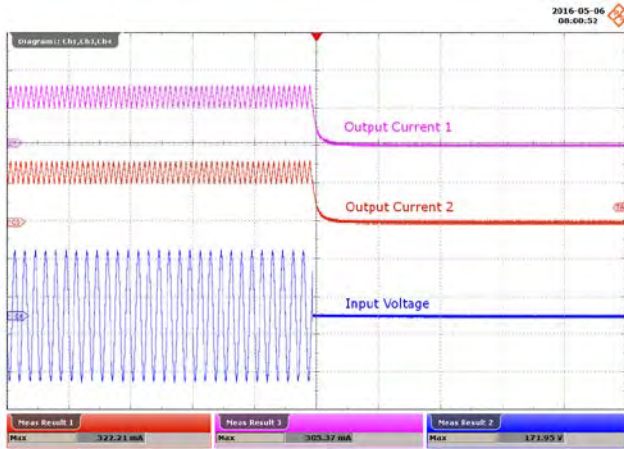

Figure 46 – 120 VAC, 60 V LEDs, Output Fall.
 Upper: I_{OUT} , 200 mA / div.
 Lower: V_{IN} , 100 V / div., 100 ms / div.

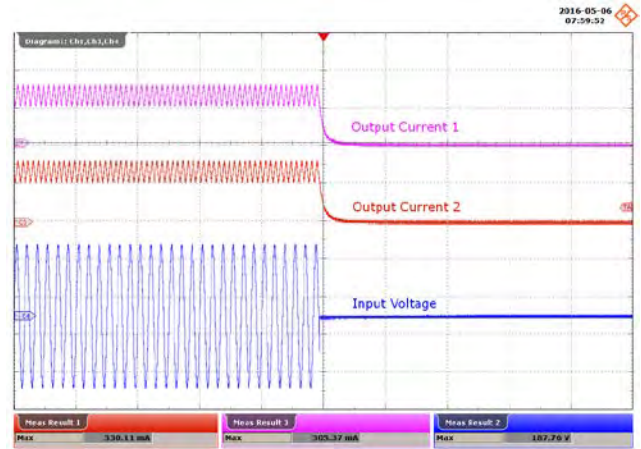

Figure 47 – 132 VAC, 60 V LEDs, Output Fall.
 Upper: I_{OUT} , 200 mA / div.
 Lower: V_{IN} , 100 V / div., 100 ms / div.



12.4 Drain Voltage and Current in Normal Operation

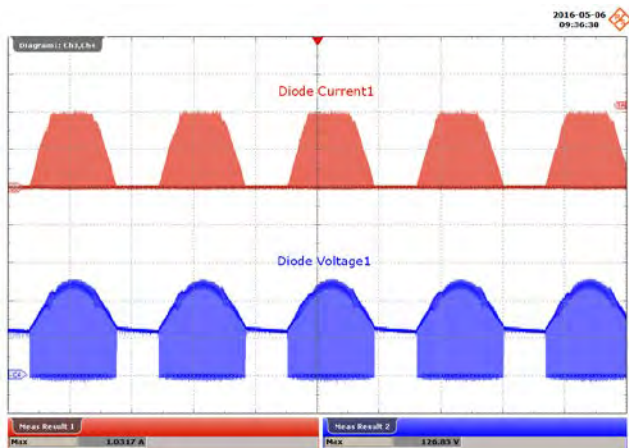

Figure 48 – 90 VAC, 60 V LED Load.
 Upper: I_{DRAIN} , 500 mA / div.
 Lower: V_{DRAIN} , 50 V / div., 4 ms / div.

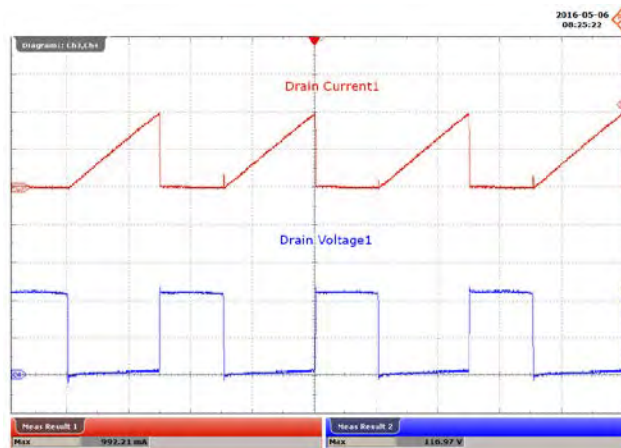

Figure 49 – 90 VAC, 60 V LED Load.
 Upper: I_{DRAIN} , 500 mA / div.
 Lower: V_{DRAIN} , 50 V / div., 10 μ s / div.

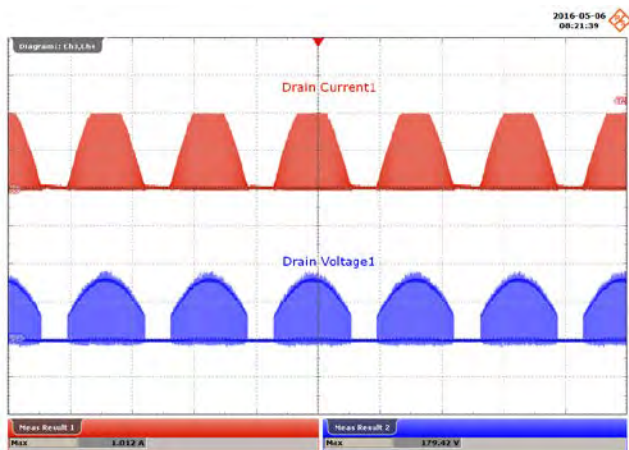

Figure 50 – 115 VAC, 60 V LED Load.
 Upper: I_{DRAIN} , 500 mA / div.
 Lower: V_{DRAIN} , 100 V / div., 4 ms / div.



Figure 51 – 115 VAC, 60 V LED Load.
 Upper: I_{DRAIN} , 500 mA / div.
 Lower: V_{DRAIN} , 50 V / div., 10 μ s / div.

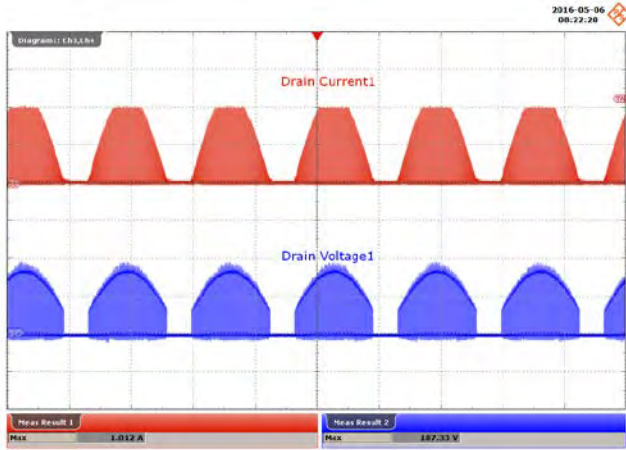

Figure 52 – 120 VAC, 60 V LED Load.
 Upper: I_{DRAIN} , 500 mA / div.
 Lower: V_{DRAIN} , 100 V / div., 4 ms / div.

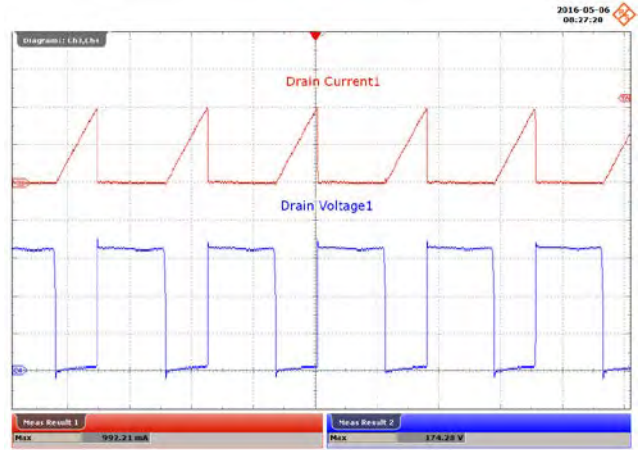

Figure 53 – 120 VAC, 60 V LED Load.
 Upper: I_{DRAIN} , 500 mA / div.
 Lower: V_{DRAIN} , 50 V / div., 10 μ s / div.

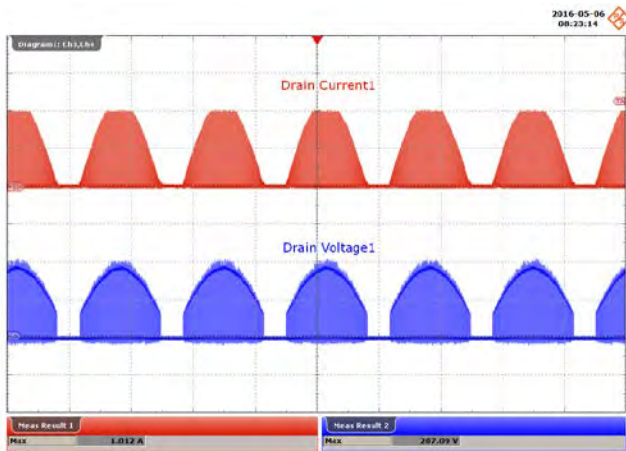

Figure 54 – 132 VAC, 60 V LED Load.
 Upper: I_{DRAIN} , 500 mA / div.
 Lower: V_{DRAIN} , 100 V / div., 4 ms / div.

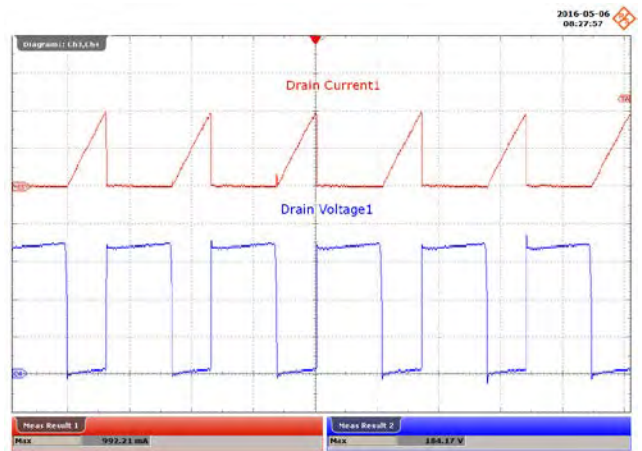

Figure 55 – 132 VAC, 60 V LED Load.
 Upper: I_{DRAIN} , 500 mA / div.
 Lower: V_{DRAIN} , 50 V / div., 10 μ s / div.

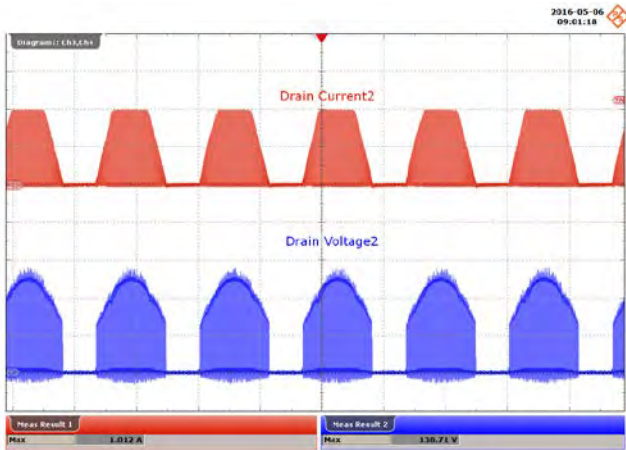

Figure 56 – 90 VAC, 60 V LED Load.
 Upper: I_{DRAIN} , 500 mA / div.
 Lower: V_{DRAIN} , 50 V / div., 4 ms / div.

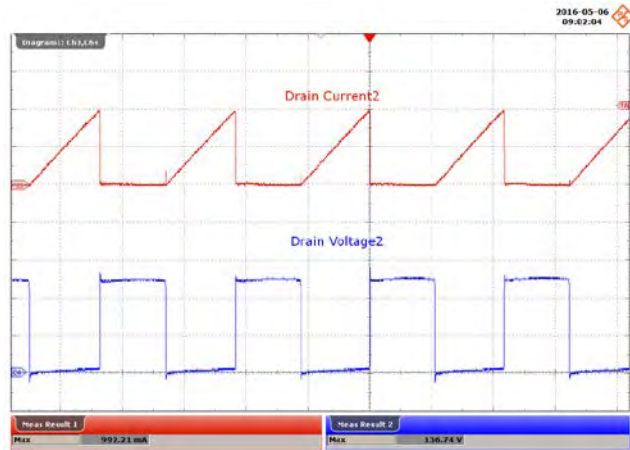

Figure 57 – 90 VAC, 60 V LED Load.
 Upper: I_{DRAIN} , 500 mA / div.
 Lower: V_{DRAIN} , 50 V / div., 10 μ s / div.

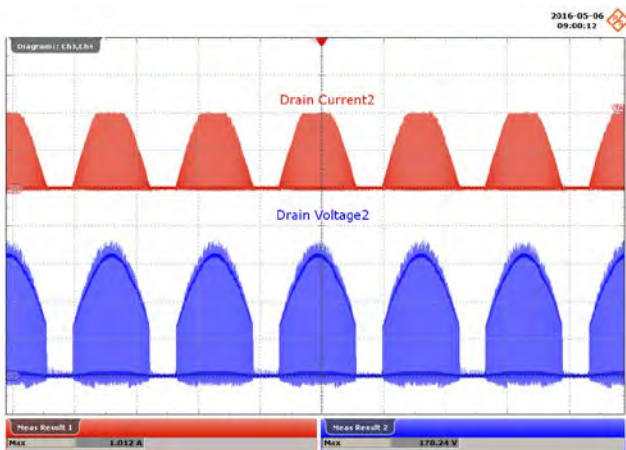

Figure 58 – 115 VAC, 60 V LED Load.
 Upper: I_{DRAIN} , 500 mA / div.
 Lower: V_{DRAIN} , 50 V / div., 4 ms / div.

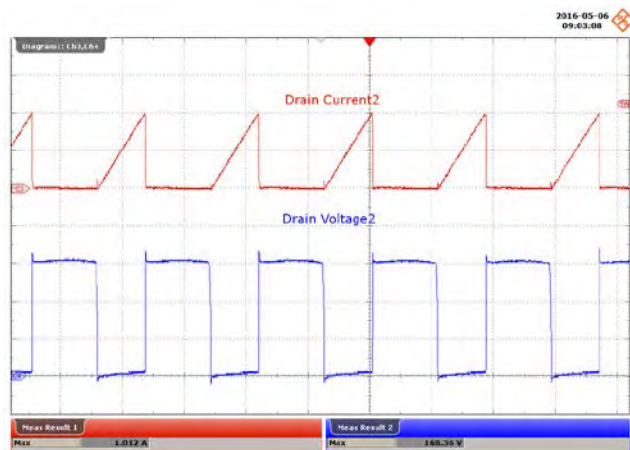

Figure 59 – 115 VAC, 60 V LED Load.
 Upper: I_{DRAIN} , 500 mA / div.
 Lower: V_{DRAIN} , 50 V / div., 10 μ s / div.

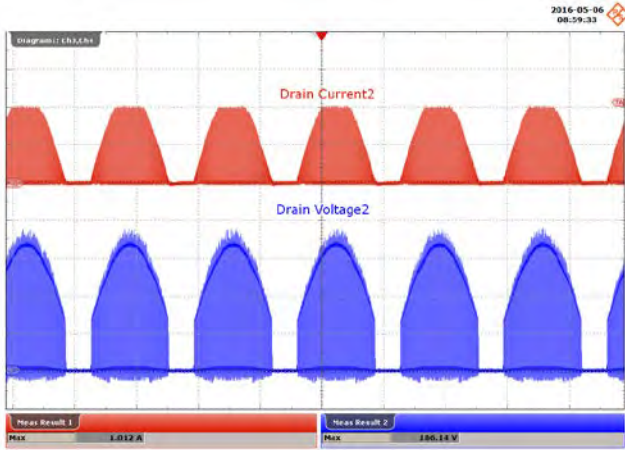

Figure 60 – 120 VAC, 60 V LED Load.
 Upper: I_{DRAIN} , 500 mA / div.
 Lower: V_{DRAIN} , 50 V / div., 4 ms / div.

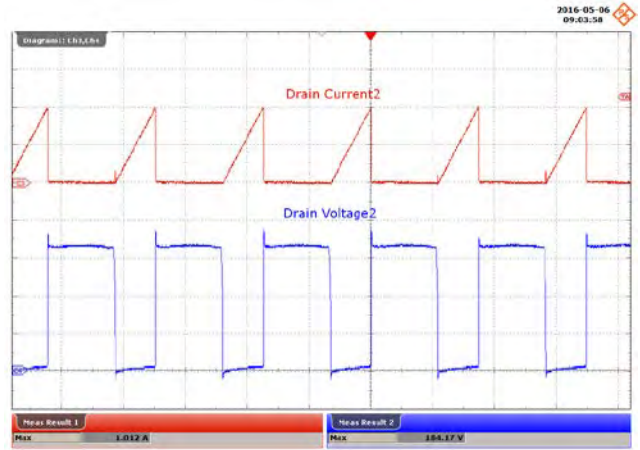

Figure 61 – 120 VAC, 60 V LED Load.
 Upper: I_{DRAIN} , 500 mA / div.
 Lower: V_{DRAIN} , 50 V / div., 10 μ s / div.

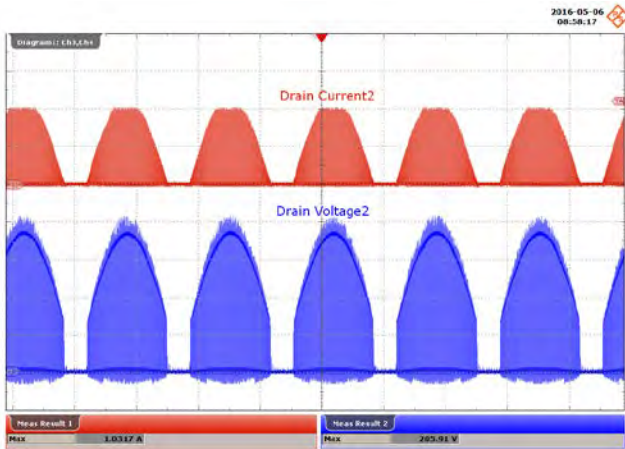

Figure 62 – 132 VAC, 60 V LED Load.
 Upper: I_{DRAIN} , 500 mA / div.
 Lower: V_{DRAIN} , 50 V / div., 4 ms / div.

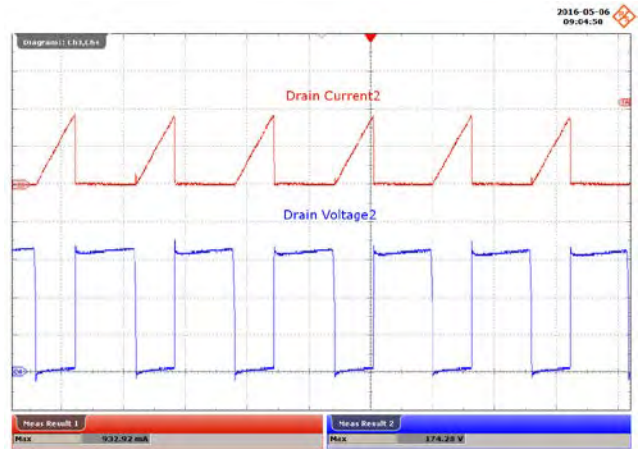

Figure 63 – 132 VAC, 60 V LED Load.
 Upper: I_{DRAIN} , 500 mA / div.
 Lower: V_{DRAIN} , 50 V / div., 10 μ s / div.

12.5 Drain Voltage and Current Start-up Profile

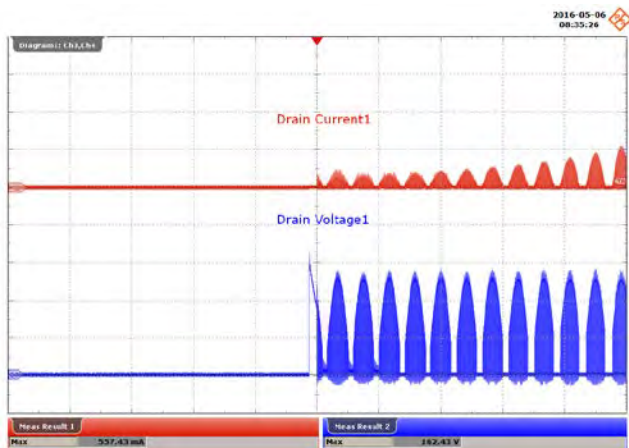

Figure 64 – 90 VAC, 60 V LED Load.
 Upper: I_{DRAIN} , 500 mA / div.
 Lower: V_{DRAIN} , 50 V / div., 20 ms / div.

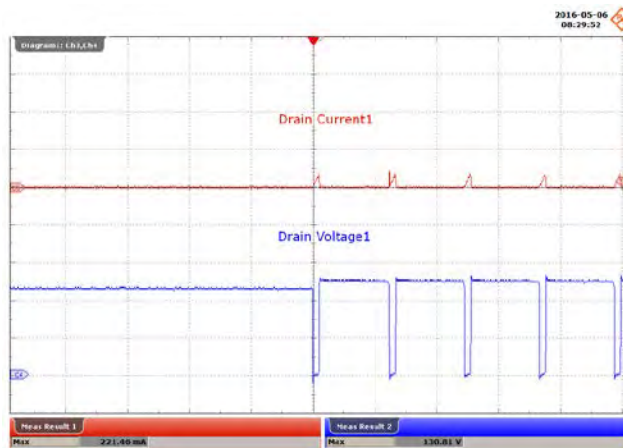

Figure 65 – 90 VAC, 60 V LED Load.
 Upper: I_{DRAIN} , 500 mA / div.
 Lower: V_{DRAIN} , 50 V / div., 10 μ s / div.

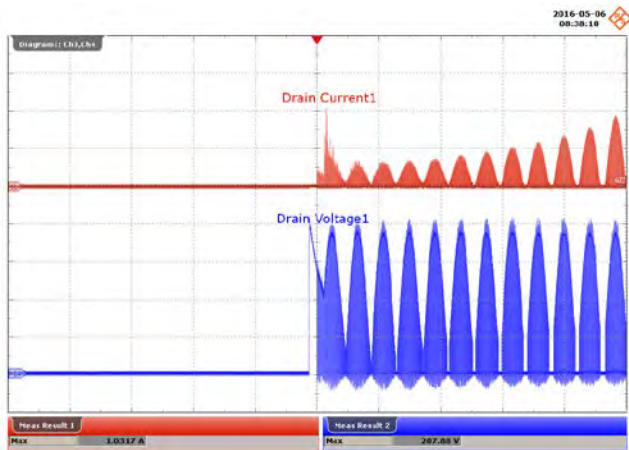

Figure 66 – 132 VAC, 60 V LED Load.
 Upper: I_{DRAIN} , 500 mA / div.
 Lower: V_{DRAIN} , 50 V / div., 20 ms / div.

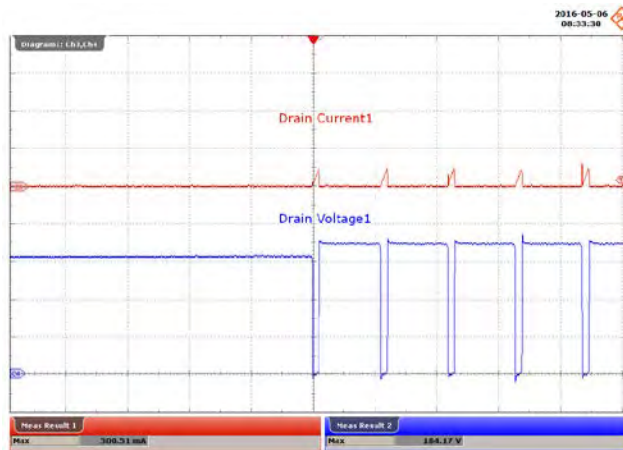

Figure 67 – 132 VAC, 60 V LED Load.
 Upper: I_{DRAIN} , 500 mA / div.
 Lower: V_{DRAIN} , 50 V / div., 4 μ s / div.

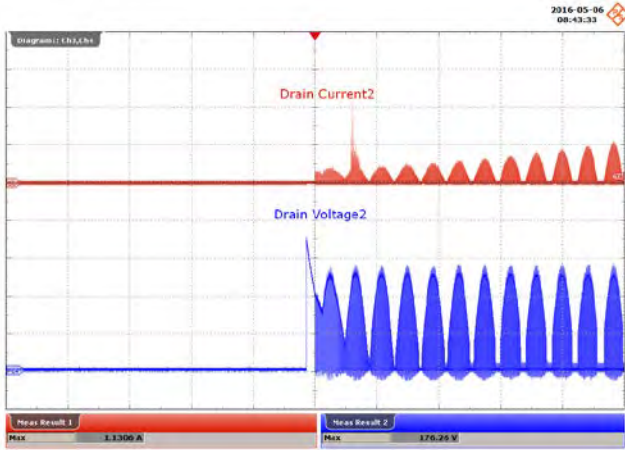

Figure 68 – 90 VAC, 60 V LED Load.
 Upper: I_{DRAIN} , 500 mA / div.
 Lower: V_{DRAIN} , 50 V / div., 20 ms / div.

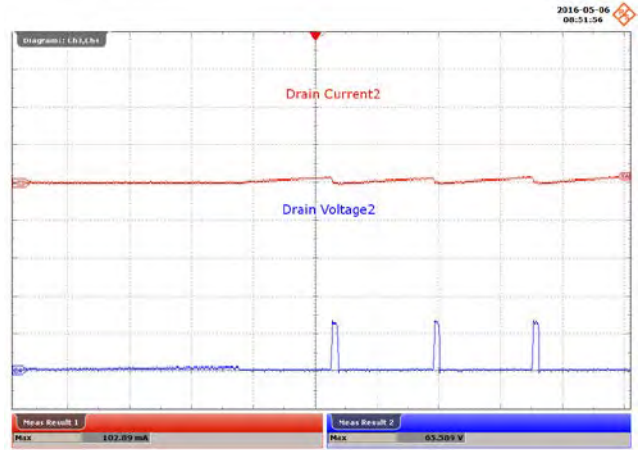

Figure 69 – 90 VAC, 60 V LED Load.
 Upper: I_{DRAIN} , 500 mA / div.
 Lower: V_{DRAIN} , 50 V / div., 10 μ s / div.

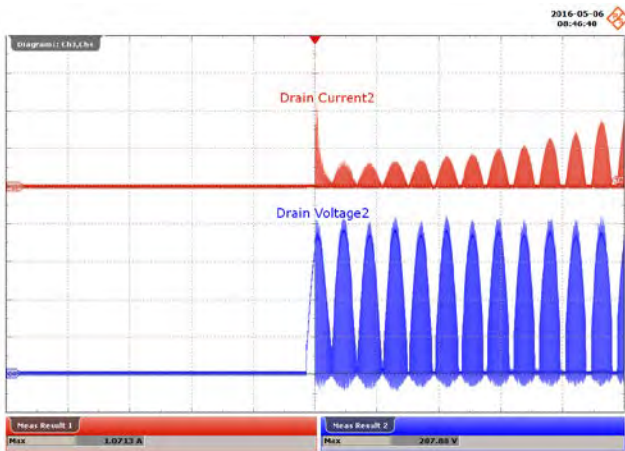

Figure 70 – 132 VAC, 60 V LED Load.
 Upper: I_{DRAIN} , 500 mA / div.
 Lower: V_{DRAIN} , 50 V / div., 20 ms / div.

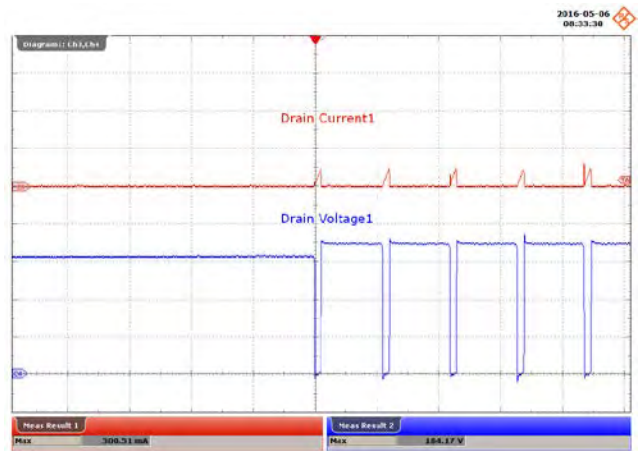

Figure 71 – 132 VAC, 60 V LED Load.
 Upper: I_{DRAIN} , 500 mA / div.
 Lower: V_{DRAIN} , 50 V / div., 4 μ s / div.

12.6 Drain Voltage and Current During Output Short-Circuit

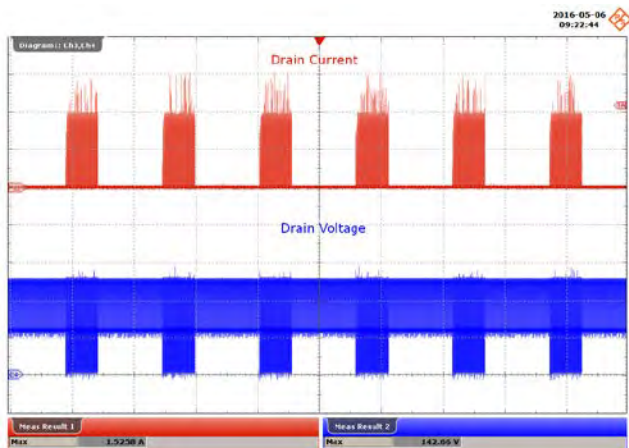

Figure 72 – 90 VAC, Output Short-Circuit.
 Upper: I_{DRAIN} , 500 mA / div.
 Lower: V_{DRAIN} , 50 V / div., 1 s / div.

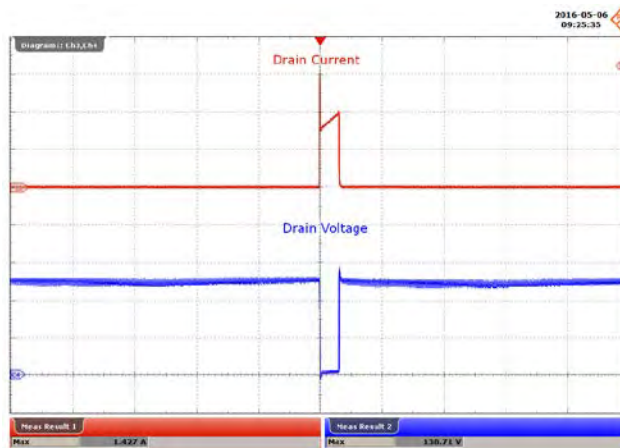

Figure 73 – 90 VAC, Output Short-Circuit.
 Upper: I_{DRAIN} , 500 mA / div.
 Lower: V_{DRAIN} , 50 V / div., 4 μ s / div.

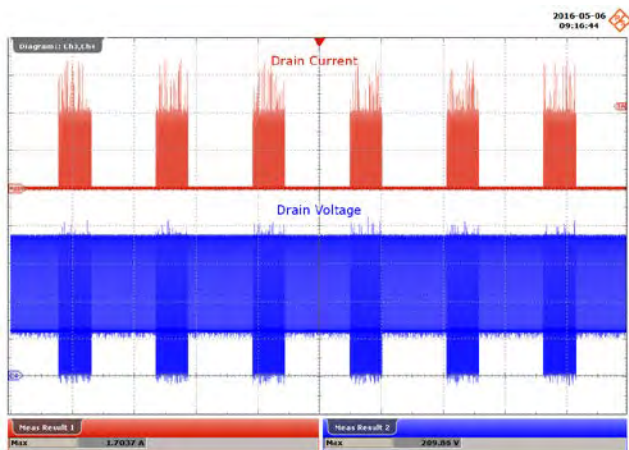

Figure 74 – 132 VAC, 60 V LED Load.
 Upper: I_{DRAIN} , 500 mA / div.
 Lower: V_{DRAIN} , 50 V / div., 20 ms / div.

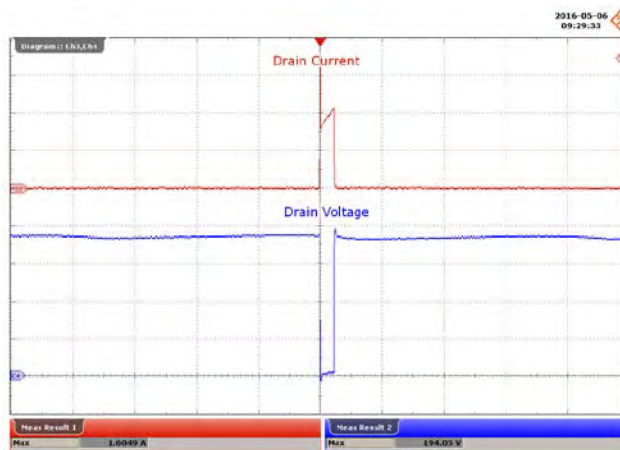

Figure 75 – 132 VAC, 60 V LED Load.
 Upper: I_{DRAIN} , 500 mA / div.
 Lower: V_{DRAIN} , 50 V / div., 4 μ s / div.

12.7 Output Diode Voltage and Current in Normal Operation

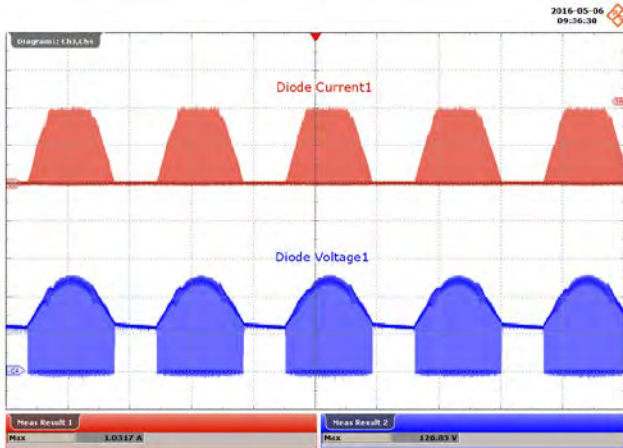

Figure 76 – 90 VAC, 60 V LED Load.
 Upper: I_{D1} , 500 mA / div.
 Lower: V_{D1} , 50 V / div., 4 ms / div.

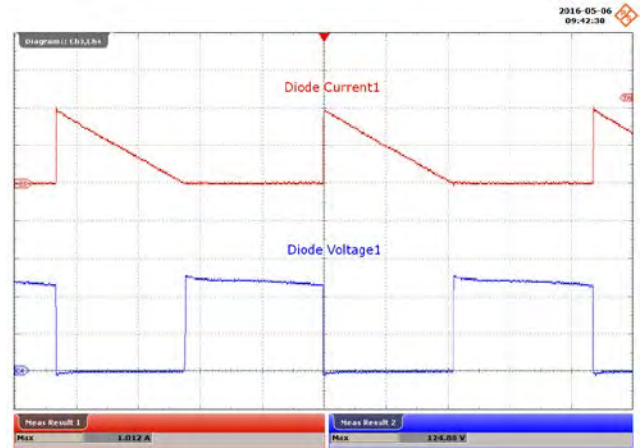

Figure 77 – 90 VAC, 60 V LED Load.
 Upper: I_{D1} , 500 mA / div.
 Lower: V_{D1} , 50 V / div., 5 μ s / div.

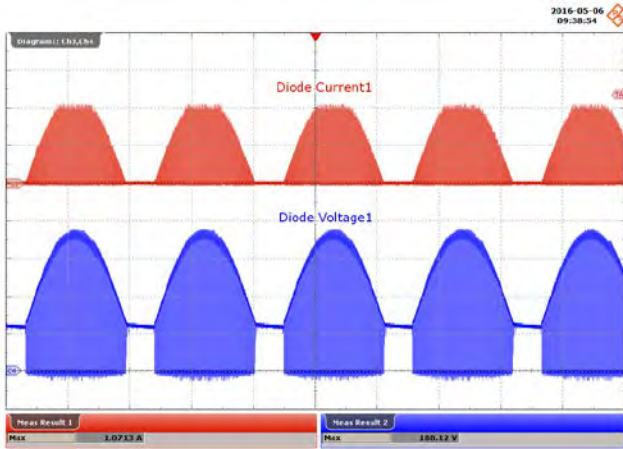

Figure 78 – 132 VAC, 60 V LED Load.
 Upper: I_{D1} , 500 mA / div.
 Lower: V_{D1} , 50 V / div., 4 ms / div.

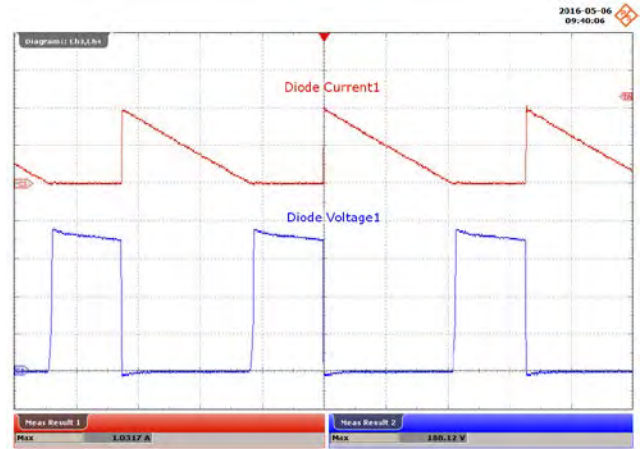

Figure 79 – 132 VAC, 60 V LED Load.
 Upper: I_{D1} , 500 mA / div.
 Lower: V_{D1} , 50 V / div., 5 μ s / div.



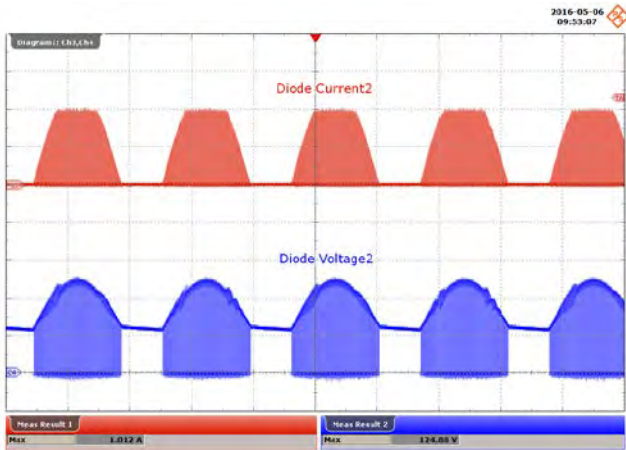

Figure 80 – 90 VAC, 60 V LED Load.
 Upper: I_{D1} , 500 mA / div.
 Lower: V_{D1} , 50 V / div., 4 ms / div.

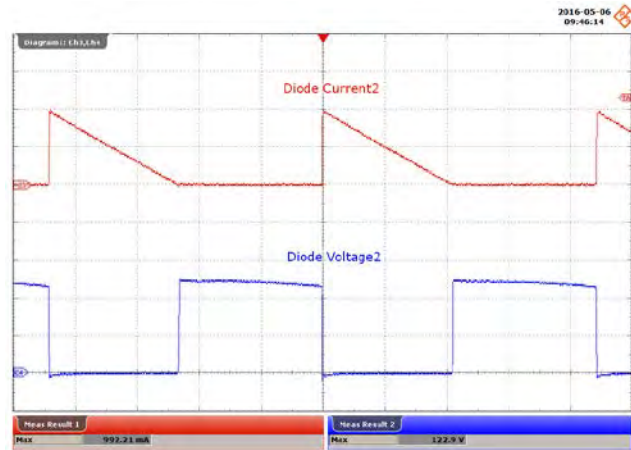

Figure 81 – 90 VAC, 60 V LED Load.
 Upper: I_{D1} , 500 mA / div.
 Lower: V_{D1} , 50 V / div., 5 μ s / div.

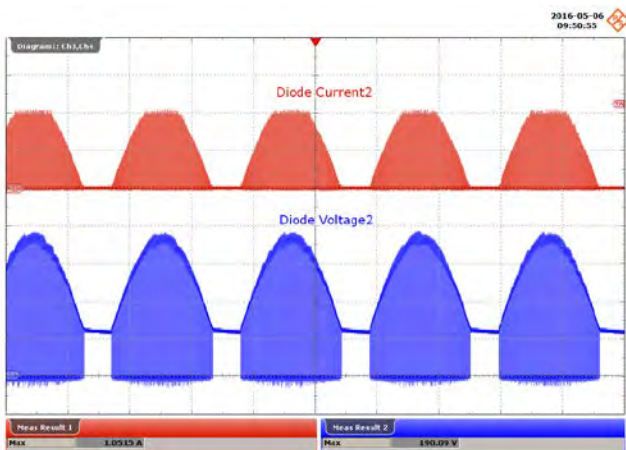

Figure 82 – 132 VAC, 60 V LED Load.
 Upper: I_{D1} , 500 mA / div.
 Lower: V_{D1} , 50 V / div., 4 ms / div.

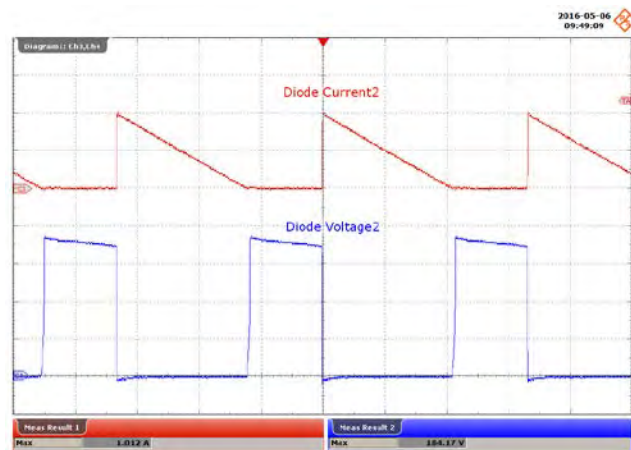

Figure 83 – 132 VAC, 60 V LED Load.
 Upper: I_{D1} , 500 mA / div.
 Lower: V_{D1} , 50 V / div., 5 μ s / div.

12.8 Output Voltage and Current – Open Output LED Load

Maximum measured no-load output voltage.



Figure 84 – 100 VAC, 60 V LED Load.
 Output 1 Running Open Load.
 Output 2 Normal Running.
 Upper: I_{OUT} , 100 mA / div.
 Lower: V_{OUT} , 20 V / div., 4 s / div.

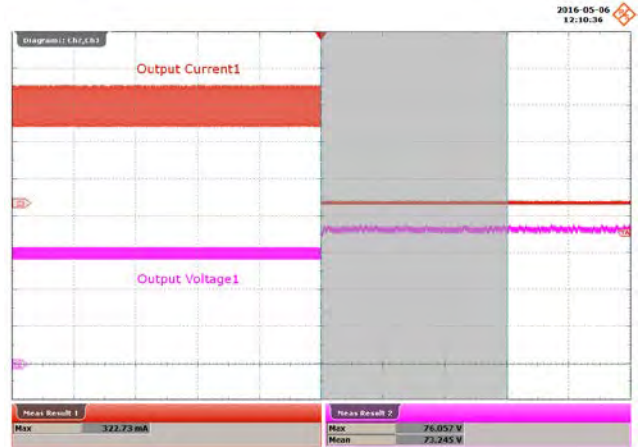

Figure 85 – 120 VAC, 60 V LED Load.
 Output 1 Running Open Load.
 Output 2 Normal Running.
 Upper: I_{OUT} , 100 mA / div.
 Lower: V_{OUT} , 20 V / div., 4 s / div.

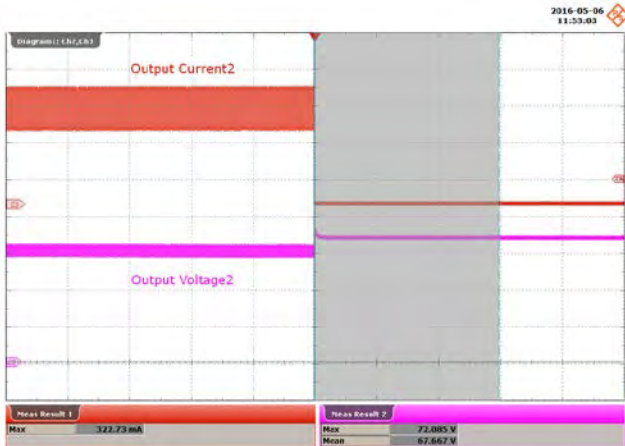

Figure 86 – 100 VAC, 60 V LED Load.
 Output 2 Running Open Load.
 Output 1 Normal Running.
 Upper: I_{OUT} , 100 mA / div.
 Lower: V_{OUT} , 20 V / div., 4 s / div.



Figure 87 – 120 VAC, 60 V LED Load.
 Output 2 Running Open Load.
 Output 1 Normal Running.
 Upper: I_{OUT} , 100 mA / div.
 Lower: V_{OUT} , 20 V / div., 4 s / div.

Note: The output capacitors can withstand the over voltage level, since based from output capacitor datasheet (ELXZ630ELL151MH20D) the surge voltage for 63 V rated is 79 V. This rating level is still above the maximum voltage measured during open load test.



12.9 Output Voltage and Current – Start-up at Open Output Load



Figure 88 – 100 VAC, 60 V LED Load.
 Open Load_1 Start-up.
 Running Load_2 Start-up.
 Upper: I_{OUT} , 100 mA / div.
 Lower: V_{OUT} , 20 V / div., 4 s / div.



Figure 89 – 100 VAC, 60 V LED Load.
 Open Load_2 Start-up.
 Running Load_1 Start-up.
 Upper: I_{OUT} , 100 mA / div.
 Lower: V_{OUT} , 20 V / div., 4 s / div.

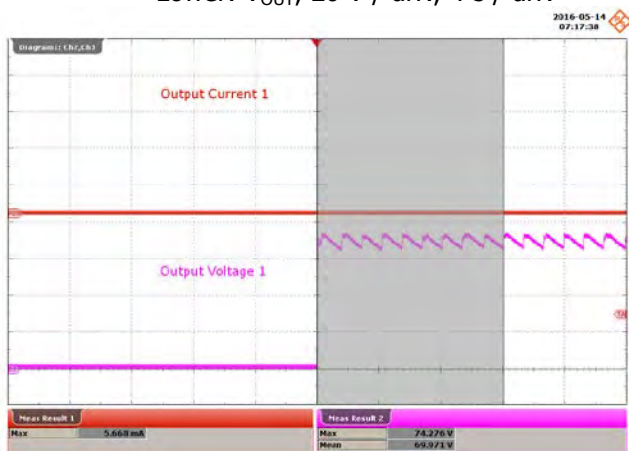

Figure 90 – 100 VAC, 60 V LED Load.
 Open Load_1 and Load_2 Start-up.
 Upper: I_{OUT} , 100 mA / div.
 Lower: V_{OUT} , 20 V / div., 4 s / div.

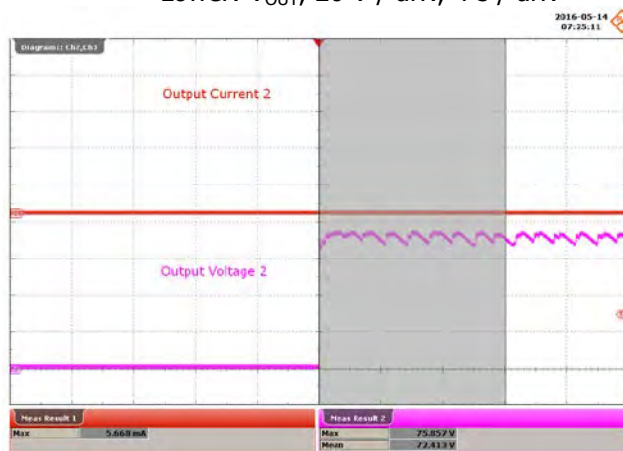

Figure 91 – 100 VAC, 60 V LED Load.
 Open Load_1 and Load_2 Start-up.
 Upper: I_{OUT} , 100 mA / div.
 Lower: V_{OUT} , 20 V / div., 4 s / div.

Note: The output capacitors can withstand the over voltage level, since based from output capacitor datasheet (ELX2630ELL151MH20D) the surge voltage for 63 V rated is 79 V. This rating level is still above the maximum voltage measured during open load test.

12.10 Output Ripple Current

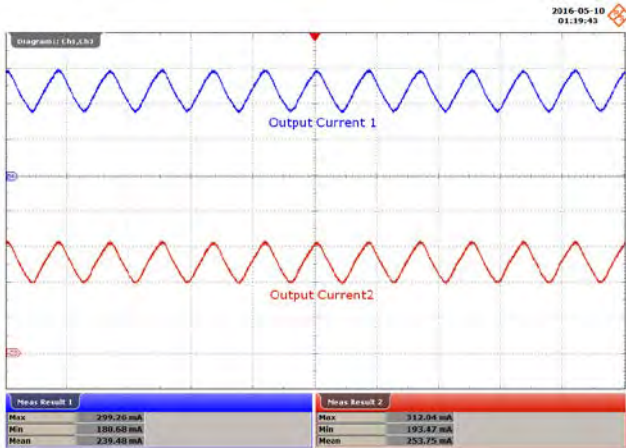

Figure 92 – 90 VAC, 60 Hz, 60 V LEDs Load.
Upper: I_{OUT} , 100 mA / div., 10 ms / div.

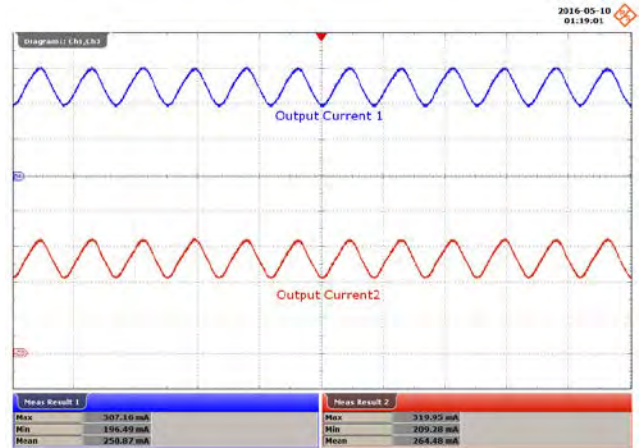

Figure 93 – 115 VAC, 60 Hz, 60 V LEDs Load.
Upper: I_{OUT} , 100 mA / div., 10 ms / div.

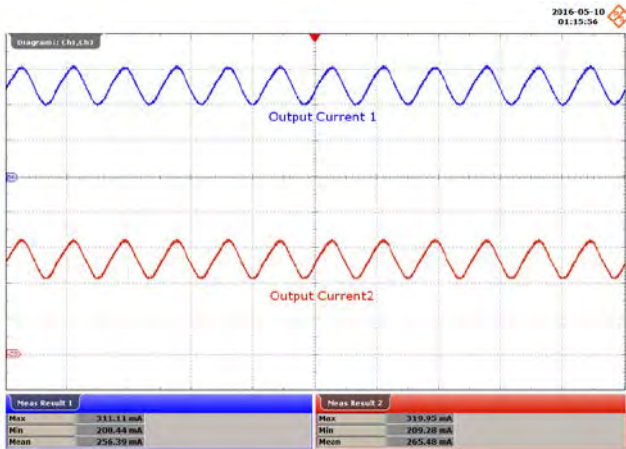

Figure 94 – 120 VAC, 60 Hz, 60 V LEDs Load.
Upper: I_{OUT} , 100 mA / div., 10 ms / div.

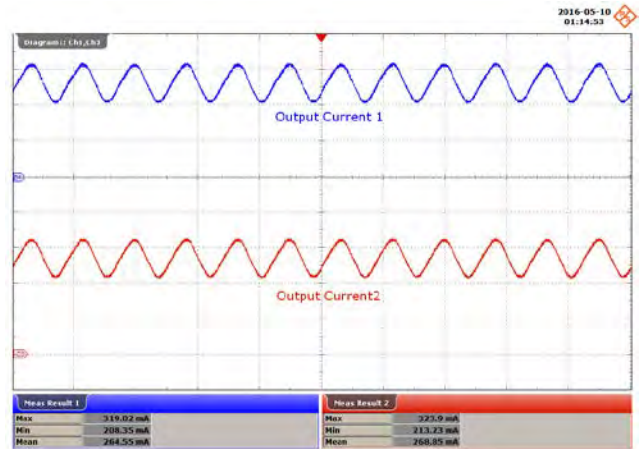

Figure 95 – 132 VAC, 60 Hz, 60 V LEDs Load.
Upper: I_{OUT} , 100 mA / div., 10 ms / div.

V_{IN} (VAC)	$I_{OUT(MAX)_1}$ (mA)	$I_{OUT(MIN)_1}$ (mA)	I_{MEAN_1}	Ripple Ratio_1 (I_{RP-P}/I_{MEAN})	% Flicker_1 ($100 \times (I_{RP-P} / I_{OUT(MAX)} + I_{OUT(MIN)})$)
90	299	181	239	0.49	24.6
115	307	196	251	0.44	22.1
120	311	200	256	0.43	21.7
132	319	208	264	0.42	21.1

V_{IN} (VAC)	$I_{OUT(MAX)_2}$ (mA)	$I_{OUT(MIN)_2}$ (mA)	I_{MEAN_2}	Ripple Ratio_2 (I_{RP-P}/I_{MEAN})	% Flicker_2 ($100 \times (I_{RP-P} / I_{OUT(MAX)} + I_{OUT(MIN)})$)
90	312	193	253	0.47	23.6
115	319	209	264	0.42	20.8
120	320	209	265	0.42	20.9
132	324	213	268	0.41	20.6



13 AC Cycling Test

No output current overshoot was observed during on - off cycling.

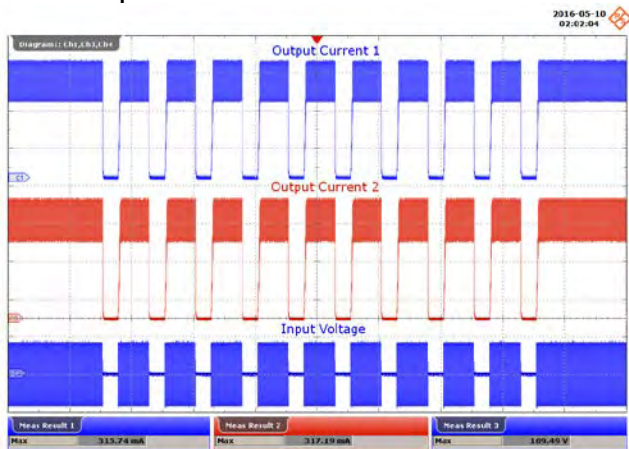

Figure 96 – 115 VAC, 60 V LED Loads.
 1 s On – 1 s Off.
 Upper: I_{OUT} , 100 mA / div.
 Lower: V_{IN} , 100 V / div., 4 s / div.

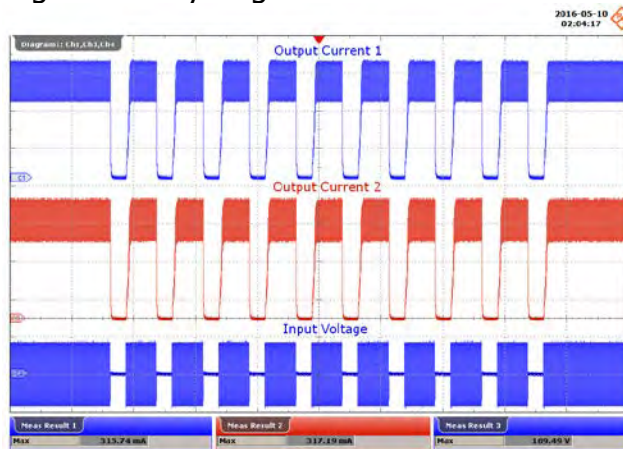

Figure 97 – 115 VAC, 60 V LED Loads.
 0.5 s On – 0.5 s Off.
 Upper: I_{OUT} , 100 mA / div.
 Lower: V_{IN} , 100 V / div., 2 s / div.

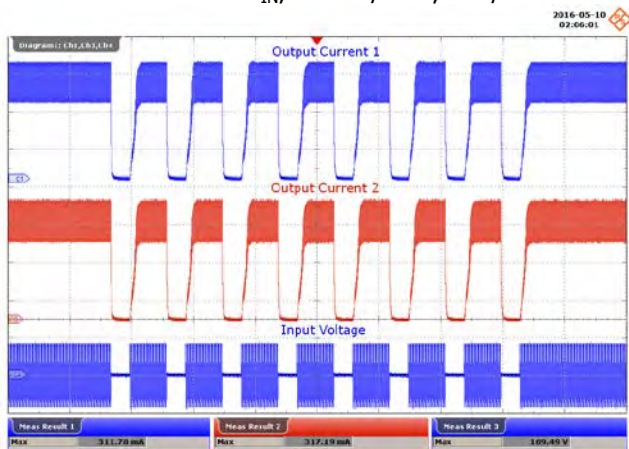

Figure 98 – 115 VAC, 60 V LED Loads.
 300 ms On – 300 ms Off.
 Upper: I_{OUT} , 100 mA / div.
 Lower: V_{IN} , 100 V / div., 1 s / div.

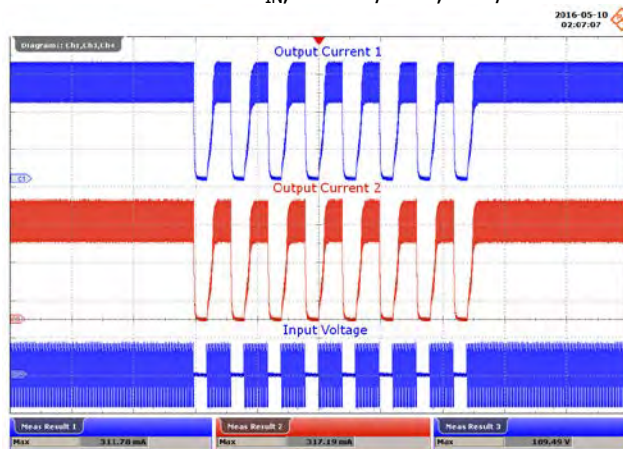

Figure 99 – 115 VAC, 60 V LED Loads.
 200 ms On – 200 ms Off.
 Upper: I_{OUT} , 100 mA / div.
 Lower: V_{IN} , 100 V / div., 1 s / div.

14 Conducted EMI

14.1 Test Set-up

14.1.1 Equipment and Load Used

1. Rohde and Schwarz ENV216 two line V-network.
2. Rohde and Schwarz ESRP EMI test receiver.
3. Hioki 3322 power hitester.
4. Chroma measurement test fixture.
5. Two 60 V LED loads with input voltage set at 115 VAC.
6. Unit inside a bulb enclosure and measured with conical EMC shield.

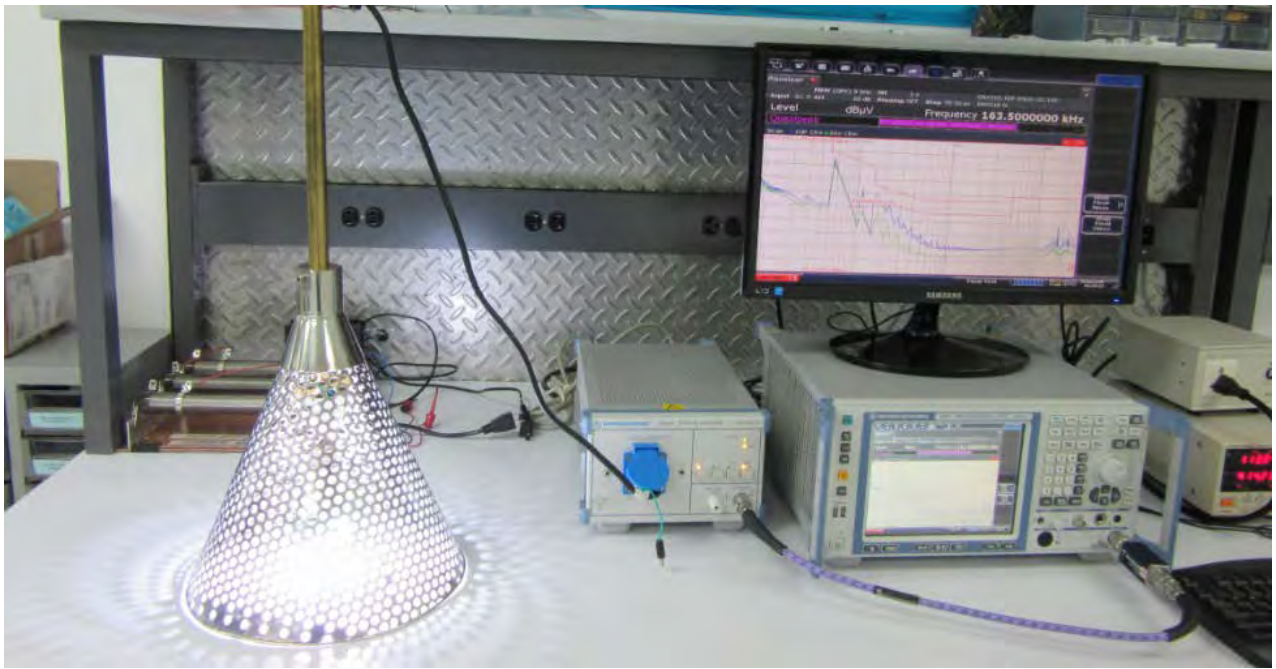

Figure 100 – Conducted EMI Test Set-up.

14.2 EMI Test Result

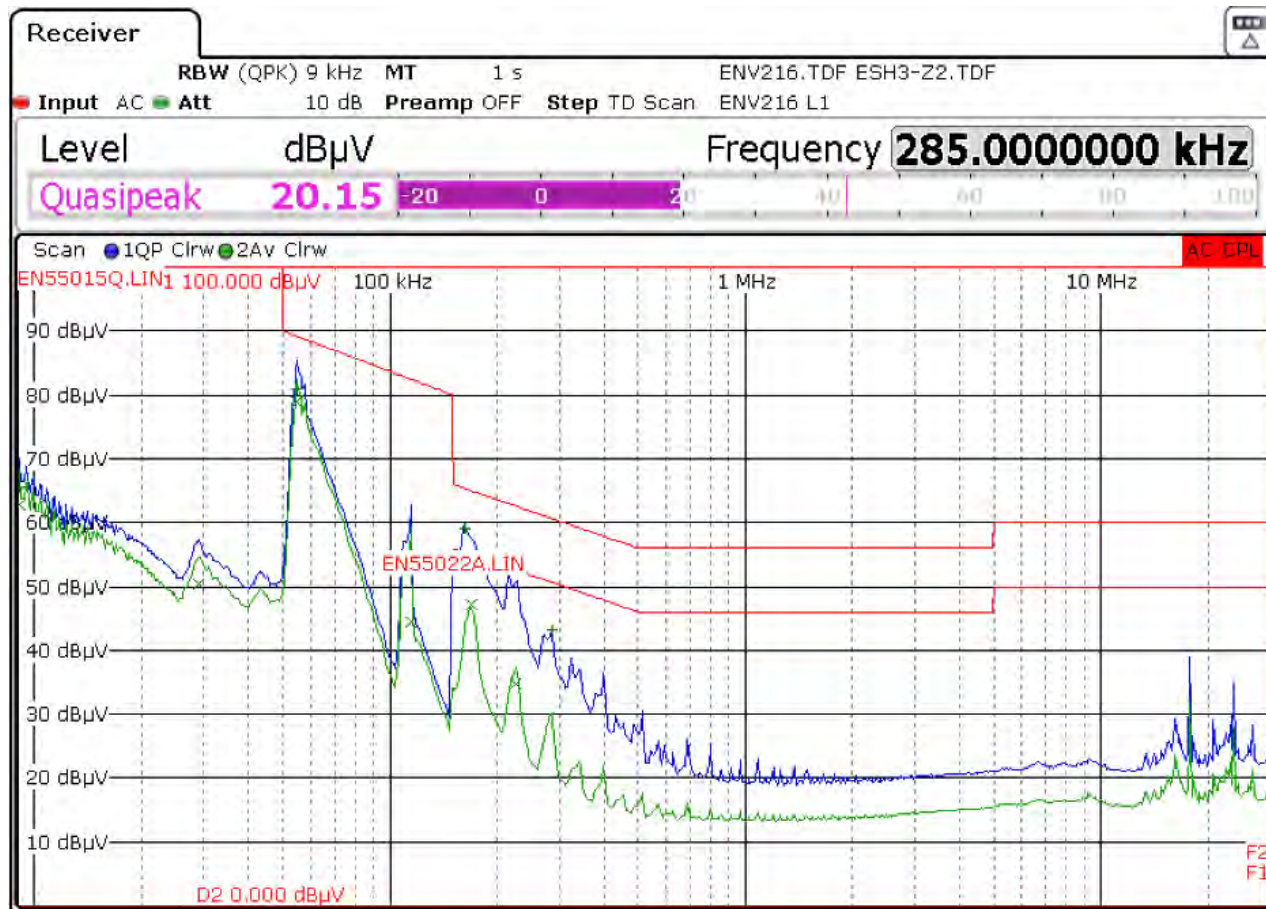

Figure 101 – Conducted EMI QP Scan at 60 V LEDs Load, 115 VAC, 60 Hz, and EN55015 B Limits.

Trace/Detector	Frequency	Level dB μ V	DeltaLimit
1 Quasi Peak	54.8500 kHz	80.83 L1	-8.33 dB
2 Average	54.8500 kHz	79.02 L1	
1 Quasi Peak	9.0500 kHz	65.59 N	-44.41 dB
2 Average	9.0500 kHz	62.66 L1	
1 Quasi Peak	163.5000 kHz	59.11 L1	-6.17 dB
2 Average	29.0000 kHz	50.45 N	
2 Average	170.2500 kHz	47.13 L1	-7.82 dB
2 Average	114.4000 kHz	44.48 L1	
1 Quasi Peak	285.0000 kHz	43.12 N	-17.55 dB
2 Average	226.5000 kHz	34.80 L1	-17.78 dB

Figure 102 – Conducted EMI Data at 115 VAC, 60 V LED Load.

15 Line Surge

The unit was subjected to ± 2500 V, 100 kHz ring wave and ± 1000 V differential surge using 10 strikes at each condition. A test failure was defined as a non-recoverable interruption of output requiring repair or recycling of input voltage.

Surge Level (V)	Input Voltage (VAC)	Injection Location	Injection Phase (°)	Test Result (Pass/Fail)
+1000	120	L to N	0	Pass
-1000	120	L to N	0	Pass
+1000	120	L to N	90	Pass
-1000	120	L to N	90	Pass

Surge Level (V)	Input Voltage (VAC)	Injection Location	Injection Phase (°)	Test Result (Pass/Fail)
+2500	120	L to N	0	Pass
-2500	120	L to N	0	Pass
+2500	120	L to N	90	Pass
-2500	120	L to N	90	Pass

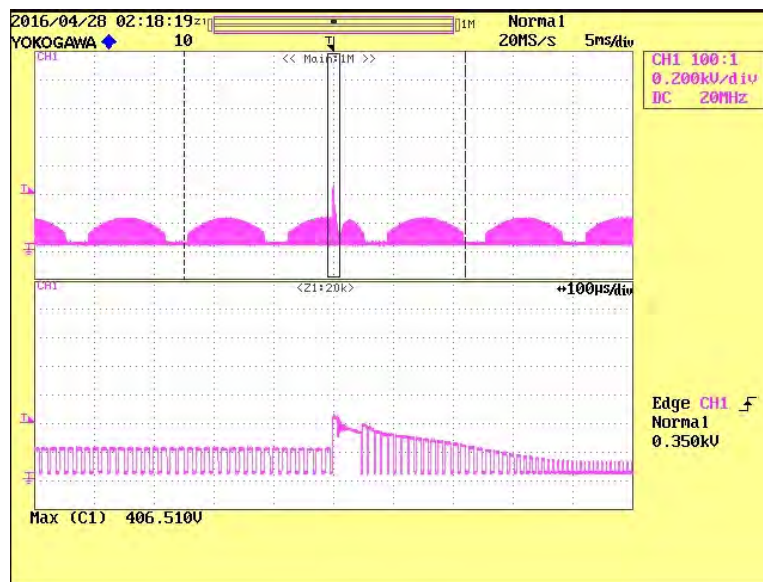

Figure 103 – +1000 kV Differential Surge, 90° Phase Angle.
 V_{DRAIN} 200 V / div., 20 ms / div.
 Peak V_{DRAIN} : 406 V.



16 Brown-in / Brown-out Test

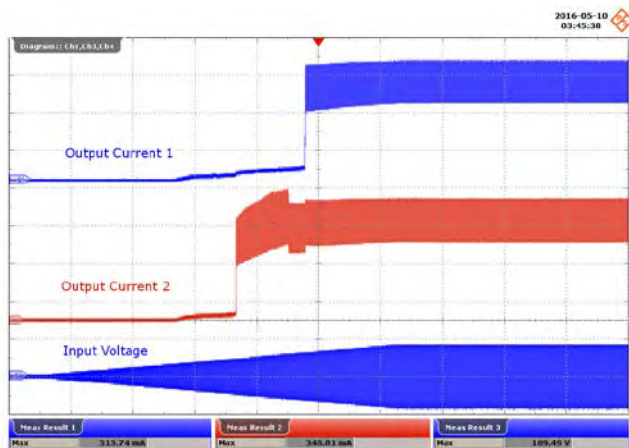

Figure 104 – Brown-in Test at 1 V / s.
 Ch1: I_{OUT} , 100 mA / div.
 Ch2: V_{IN} , 100 V / div.
 Time Scale: 40 s / div.

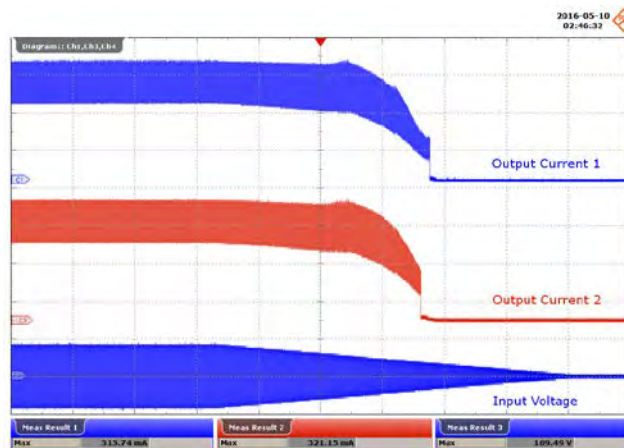

Figure 105 – Brown-out Test at 1 V / s.
 Ch1: I_{OUT} , 100 mA / div.
 Ch2: V_{IN} , 100 V / div.
 Time Scale: 40 s / div.

17 Revision History

Date	Author	Revision	Description and Changes	Reviewed
17-Aug-16	IBB	1.0	Initial release	Apps & Mktg



For the latest updates, visit our website: www.power.com

Power Integrations reserves the right to make changes to its products at any time to improve reliability or manufacturability. Power Integrations does not assume any liability arising from the use of any device or circuit described herein. POWER INTEGRATIONS MAKES NO WARRANTY HEREIN AND SPECIFICALLY DISCLAIMS ALL WARRANTIES INCLUDING, WITHOUT LIMITATION, THE IMPLIED WARRANTIES OF MERCHANTABILITY, FITNESS FOR A PARTICULAR PURPOSE, AND NON-INFRINGEMENT OF THIRD PARTY RIGHTS.

Patent Information

The products and applications illustrated herein (including transformer construction and circuits' external to the products) may be covered by one or more U.S. and foreign patents, or potentially by pending U.S. and foreign patent applications assigned to Power Integrations. A complete list of Power Integrations' patents may be found at www.power.com. Power Integrations grants its customers a license under certain patent rights as set forth at <http://www.power.com/ip.htm>.

The PI Logo, TOPSwitch, TinySwitch, LinkSwitch, LYTSwitch, InnoSwitch, DPA-Switch, PeakSwitch, CAPZero, SENZero, LinkZero, HiperPFS, HiperTFS, HiperLCS, Qspeed, EcoSmart, Clampless, E-Shield, Filterfuse, FluxLink, StackFET, PI Expert and PI FACTS are trademarks of Power Integrations, Inc. Other trademarks are property of their respective companies. ©Copyright 2015 Power Integrations, Inc.

Power Integrations Worldwide Sales Support Locations**WORLD HEADQUARTERS**

5245 Hellyer Avenue
San Jose, CA 95138, USA.
Main: +1-408-414-9200
Customer Service:
Phone: +1-408-414-9665
Fax: +1-408-414-9765
e-mail: usasales@power.com

GERMANY

Lindwurmstrasse 114
80337, Munich
Germany
Phone: +49-895-527-39110
Fax: +49-895-527-39200
e-mail: eurosales@power.com

JAPAN

Kosei Dai-3 Building
2-12-11, Shin-Yokohama,
Kohoku-ku, Yokohama-shi,
Kanagawa 222-0033
Japan
Phone: +81-45-471-1021
Fax: +81-45-471-3717
e-mail: japansales@power.com

TAIWAN

5F, No. 318, Nei Hu Rd.,
Sec. 1
Nei Hu District
Taipei 11493, Taiwan R.O.C.
Phone: +886-2-2659-4570
Fax: +886-2-2659-4550
e-mail:
taiwansales@power.com

CHINA (SHANGHAI)

Rm 2410, Charity Plaza, No. 88,
North Caoxi Road,
Shanghai, PRC 200030
Phone: +86-21-6354-6323
Fax: +86-21-6354-6325
e-mail: chinasales@power.com

INDIA

#1, 14th Main Road
Vasanthanagar
Bangalore-560052
India
Phone: +91-80-4113-8020
Fax: +91-80-4113-8023
e-mail: indiasales@power.com

KOREA

RM 602, 6FL
Korea City Air Terminal B/D,
159-6
Samsung-Dong, Kangnam-Gu,
Seoul, 135-728 Korea
Phone: +82-2-2016-6610
Fax: +82-2-2016-6630
e-mail: koreasales@power.com

UK

Cambridge Semiconductor,
a Power Integrations company
Westbrook Centre, Block 5,
2nd Floor
Milton Road
Cambridge CB4 1YG
Phone: +44 (0) 1223-446483
e-mail: eurosales@power.com

CHINA (SHENZHEN)

17/F, Hivac Building, No. 2, Keji
Nan 8th Road, Nanshan District,
Shenzhen, China, 518057
Phone: +86-755-8672-8689
Fax: +86-755-8672-8690
e-mail: chinasales@power.com

ITALY

Via Milanese 20, 3rd. Fl.
20099 Sesto San Giovanni (MI)
Italy
Phone: +39-024-550-8701
Fax: +39-028-928-6009
e-mail: eurosales@power.com

SINGAPORE

51 Newton Road,
#19-01/05 Goldhill Plaza
Singapore, 308900
Phone: +65-6358-2160
Fax: +65-6358-2015
e-mail: singaporesales@power.com

