

Design Example Report

Title	<i>4.5 W TRIAC Dimmable Buck LED Driver Using LYTSwitch™-3 LYT3325DG</i>
Specification	185 VAC – 265 VAC Input; 27 V - 33 V, 0.15 A _{TYP} Output
Application	MR-16 GU-10 Bulb
Author	Applications Engineering Department
Document Number	DER-498
Date	April 8, 2016
Revision	1.0

Summary and Features

- Single-stage power factor corrected, PF >0.7
- Accurate constant LED current (CC) regulation, ±5%
- Highly energy efficient, >84% at 230 V
- Low cost and low component count for compact PCB solution
- TRIAC dimmable
 - Works with a wide selection of TRIAC dimmers
 - Fast start-up time (<500 ms) – no perceptible delay
- Integrated protection features
 - No-load and output short-circuit protection
 - Thermal fold-back protection
 - No damage during line brown-out or brown-in conditions
- A-THD <20% at 230 VAC
- Meets IEC 2.5 kV ring wave, 1 kV differential surge
- Meets EN55015 conducted EMI

PATENT INFORMATION

The products and applications illustrated herein (including transformer construction and circuits external to the products) may be covered by one or more U.S. and foreign patents, or potentially by pending U.S. and foreign patent applications assigned to Power Integrations. A complete list of Power Integrations' patents may be found at www.powerint.com. Power Integrations grants its customers a license under certain patent rights as set forth at <http://www.powerint.com/ip.htm>.

Power Integrations

5245 Hellyer Avenue, San Jose, CA 95138 USA.
Tel: +1 408 414 9200 Fax: +1 408 414 9201
www.power.com

Table of Contents

1	Introduction	4
2	Power Supply Specification	6
3	Schematic	7
4	Circuit Description	8
4.1	Input Stage	8
4.2	EMI Filters	8
4.3	LYTSwitch-3 Primary Control Circuit	8
4.4	TRIAC Phase Dimming Control with LYTSwitch-3 Smart Bleeder Drive	9
5	PCB Layout	11
6	Bill of Materials	12
7	Inductor Specification	13
7.1	Electrical Diagram	13
7.2	Electrical Specifications	13
7.3	Material List	13
7.4	Inductor Build Diagram	14
7.5	Inductor Construction	14
7.6	Winding Illustrations	15
8	Inductor Design Spreadsheet	21
9	Performance Data	23
9.1	Efficiency	23
9.2	Line Regulation	24
9.3	Power Factor	25
9.4	%ATHD	26
9.5	Harmonics	27
9.5.1	27 V LED Load	27
9.5.2	30 V LED Load	28
9.5.3	33 V LED Load	29
10	Test Data	30
10.1	Test Data, 27 V LED Load	30
10.2	Test Data, 30 V LED Load	30
10.3	Test Data, 33 V LED Load	30
10.4	Test Data, Harmonic Content at 230 VAC with 27 V LED Load	31
10.5	Test Data, Harmonic Content at 230 VAC with 30 V LED Load	32
10.6	Test Data, Harmonic Content at 230 VAC with 33 V LED Load	33
11	Dimming Performance Data	34
11.1	Dimming Curve	34
11.2	Dimming Efficiency	35
11.3	Driver Power Loss During Dimming	36
11.4	Driver Compatibility List	37
12	Thermal Performance	38
12.1	Non-Dimming Thermal Performance at 185 VAC with a 30 V LED Load	40
12.2	Non-Dimming Thermal Performance at 230 VAC with a 30 V LED Load	41



12.3	Non-Dimming Thermal Performance at 265 VAC with a 30 V LED Load	42
12.4	Dimming Thermal Performance at 230 VAC, 87° Conduction Angle	43
12.5	Dimming Thermal Performance at 230 VAC, 130° Conduction Angle	44
12.6	Dimming with Output Short-Circuit Condition at 40 °C Ambient	45
12.7	Dimming with TRIAC Dimmer Multi-fire Condition at 40 °C Ambient.....	46
12.8	10 Hour Burn-in at 40 °C Ambient	47
13	Waveforms	50
13.1	Input Voltage and Input Current Waveforms	50
13.2	Output Current Rise and Fall	51
13.3	Drain Voltage and Current in Normal Operation	53
13.4	Drain Voltage and Current Start-up Profile.....	55
13.5	Drain Voltage and Current during Output Short-Circuit Condition	57
13.6	Output Diode Voltage and Current in Normal Operation	59
13.7	Output Voltage and Current – Open LED Load.....	61
13.8	Output Ripple Current	62
14	Dimming Waveforms	63
14.1	Input Voltage and Input Current Waveforms – Leading Edge Dimmer	63
14.2	Output Current Waveforms – Leading Edge Dimmer	64
14.3	Input Voltage and Input Current Waveforms – Trailing Edge Dimmer	65
14.4	Output Current Waveforms – Trailing Edge Dimmer.....	66
15	AC Cycling Test.....	67
16	Conducted EMI	68
16.1	Test Set-up	68
16.1.1	Equipment and Load Used	68
16.2	EMI Test Result	69
17	Line Surge	70
18	Brown-in/Brown-out Test	71
19	Revision History	72

Important Note: Although this board is designed to satisfy safety isolation requirements, the engineering prototype has not been agency approved. Therefore, all testing should be performed using an isolation transformer to provide the AC input to the prototype board.

1 Introduction

This engineering report describes a TRIAC-dimmable, non-isolated buck LED driver designed to drive a nominal LED voltage string of 30 V at 150 mA from an input voltage range of 185 VAC to 265 VAC. The LED driver utilizes the LYT3325D from the LYTSwitch-3 family of devices.

The LYTSwitch-3 is a family of devices which are designed especially for TRIAC-dimmable LED drivers with a single stage PFC function and accurate LED current control.

The DER-498 provides a single 4.5 W TRIAC-dimmable, constant-current output. The key design goals were high efficiency, low component temperature, and excellent dimming compatibility. This design is intended for GU10 LED applications.

The document contains the power supply specification, schematic, bill of materials, transformer documentation, printed circuit layout, design spreadsheet and performance data.



Figure 1 – Populated Circuit Board.

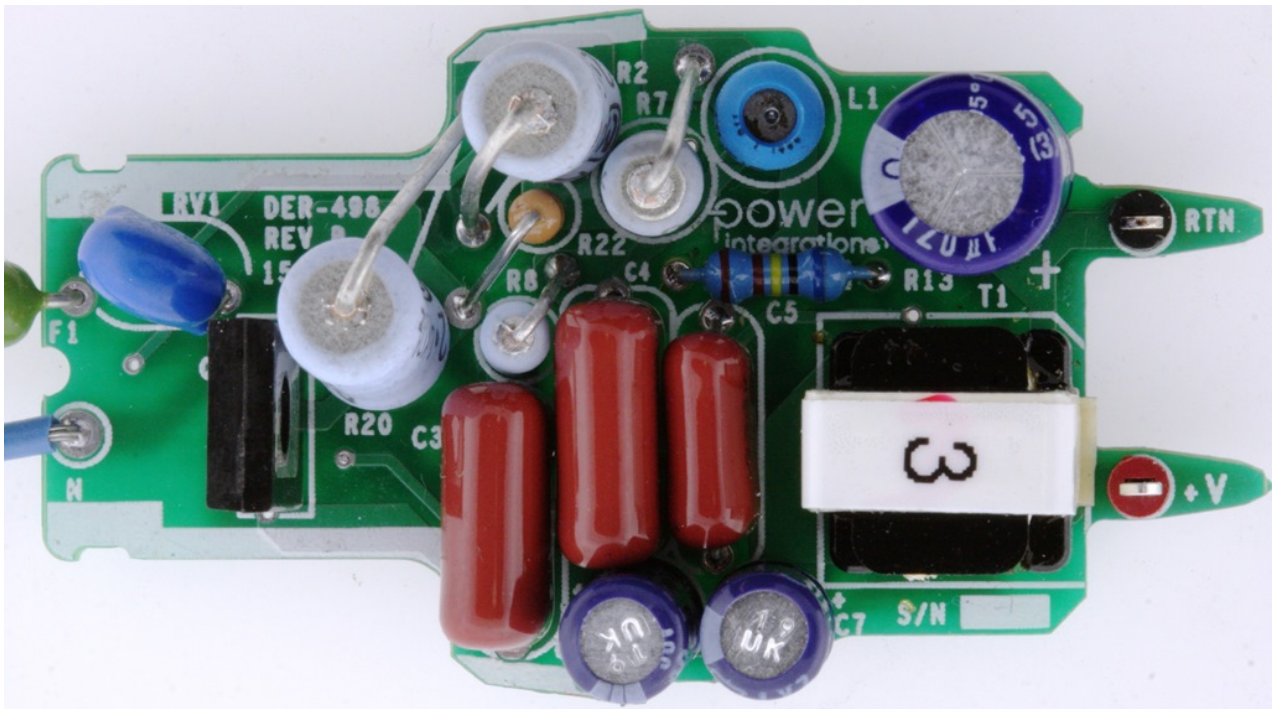

Figure 2 – Populated Circuit Board, Top View.

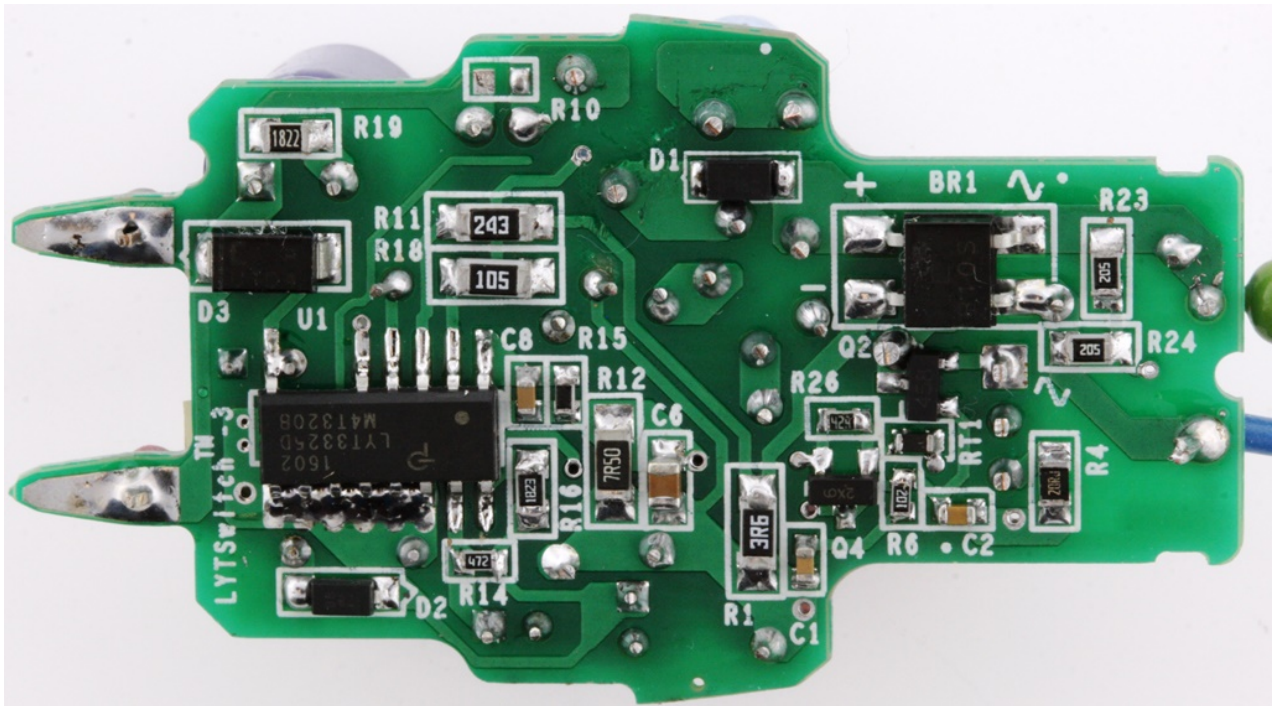

Figure 3 – Populated Circuit Board, Bottom View.

2 Power Supply Specification

The table below represents the minimum acceptable performance of the design. Actual performance is listed in the results section.

Description	Symbol	Min	Typ	Max	Units	Comment
Input Voltage	V_{IN}	185	230	265	VAC	2 Wire – no P.E.
Frequency	f_{LINE}		50/60		Hz	
Output Output Voltage	V_{OUT}	27	30	33	V	
Output Current	I_{OUT}	142.5	150	157.5	mA	
Total Output Power Continuous Output Power	P_{OUT}		4.5		W	
Efficiency Full Load	η		82		%	Measured at 230 VAC, 25 °C
Environmental Conducted EMI			CISPR 15B / EN55015B			
Safety			Isolated			
Ring Wave (100 kHz)			2.5		kV	
Differential Mode (L1-L2)			1.0		kV	
Power Factor			0.7			Measured at 230 VAC, 50 Hz.
Ambient Temperature	T_{AMB}			40	°C	Free Convection, Sea Level.

3 Schematic

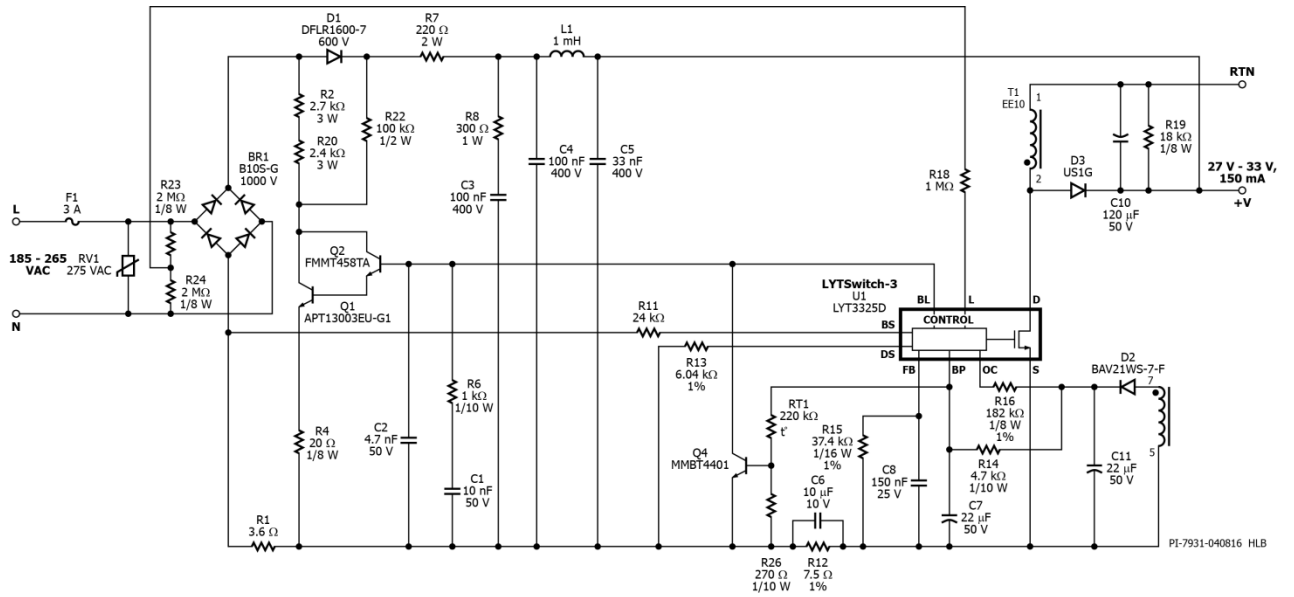

Figure 4 – Schematic.



4 Circuit Description

The LYTSwitch-3 LYT3325D combines a high-voltage power MOSFET switch with a power supply controller in a single package. The LYTSwitch-3 controller provides single-stage power factor correction, LED current control, and dimming control.

4.1 Input Stage

Fuse F1 provides protection against component short circuit failure drawing large current from the input. Varistor RV1 acts as a clamp to limit the maximum voltage spike on the primary during differential line surge events. A 275 VAC rated part was selected, being slightly above the maximum specified operating voltage (265 VAC).

To provide input line voltage information to U1, the input AC voltage is sensed directly before the bridge rectifier diode through sampling resistors R23 and R24. The LINE-SENSE (L) pin current set through resistor R18 is used to activate input OVP functions, to detect the presence of a dimmer, and to control the output LED current with respect to the line.

The AC input is full wave rectified by BR1 to provide the pulsating DC input to the π filter.

4.2 EMI Filters

The differential choke L1 and input filter capacitors, C4 and C5, form the EMI π filter. The EMI filter, together with the LYTSwitch-3 frequency jittering feature, ensures compliance with the EN55015 Class B emission limit.

The values of C4, C5, and L1 were chosen to provide the best balance between high efficiency, power factor, EMI performance, and dimming compatibility.

4.3 LYTSwitch-3 Primary Control Circuit

The topology is a buck with a low-side switch. The primary winding (buck inductor) un-dotted-end of the transformer (T1) is connected to the DC bus, and the dotted-end terminal is connected to the DRAIN (D) pin of the LYTSwitch-3 IC. During the on-time of the power MOSFET, current ramps through the primary winding, storing energy in the magnetizing inductance which is then delivered to the output load via output diode D3 during the power MOSFET off-time. Output capacitor C10 provides output voltage filtering minimizing the output LED ripple current and helps to achieve good response of output current rise during start-up. Resistor R19 serves as a 50 mW pre-load to minimize low light output due to leakage during the dimmer off-state.

Diode D2 and C11 provide the primary bias supply for U1 from an auxiliary winding on the transformer. This external bias supply set through R14 is necessary to give the lowest device dissipation and provide sufficient supply to U1 during the deep dimming condition.

Capacitor C7 provides local decoupling for the BYPASS (BP) pin of U1, which is the supply pin for the IC. During start-up, C7 is charged to ~5.25 V from an internal high-voltage current source connected to the D pin. An electrolytic capacitor was used for C7 to maintain a stable supply at high ambient temperatures.

With reference to the FEEDBACK (FB) pin full conduction preset threshold of 300 mV, a corresponding voltage across R12 senses the output LED current through U1's drain current and is then fed into the DRIVER CURRENT SENSE (DS) pin via R13 to maintain constant output current regulation. This voltage is compared to the voltage across R15 internally to the 300 mV reference voltage which varies linearly with the conduction angle when in dimming mode. The capacitor C10 provides voltage filtering to generate a DC reference voltage and to reduce any ripple voltage spike.

IC U1 OUTPUT COMPENSATION (OC) pin senses the output voltage through R16 for the output OVP function at open load and for optimized LED current regulation with respect to variation in the LED string voltage. Output OVP is activated with the IC latching off when the OC pin voltage exceeds the OV threshold.

4.4 *TRIAC Phase Dimming Control with LYTSwitch-3 Smart Bleeder Drive*

Due to the much lower power consumed by LED-based lighting, the current drawn by the lamp is below the holding current of the TRIAC in many dimmers. This causes undesirable behavior such as limited dimming range and/or flicker. The relatively large impedance presented to the line by the LED allows significant ringing to occur due to the inrush current charging the input capacitance when the TRIAC turns on. This effect can cause similar undesirable behavior, as the ringing may cause the TRIAC current to fall below its holding current and turn off.

To overcome these issues, a passive damper and an active bleeder are used.

Resistor R7 dampens the driver input current ringing when the TRIAC dimmer turns on. Diode D1 serves as a blocking diode to prevent current draw from the input filter capacitors C4 and C5 when the bleeder turns on. Resistor R22 serves as a discharge path for the input capacitors to increase dimmer compatibility of the driver.

The active bleeder is modulated by the LYTSwitch-3 BLEEDER CONTROL (BL) pin in a closed-loop system while sensing the input voltage and input current.

Resistor R2, R20, R4, Q1 and Q2 form an external bleeder circuit driven by LYTSwitch-3. Resistor R2 and R20 are the bleeder resistors and Q1 is the bleeder switch. Transistor Q2 uses a Darlington connection with Q1 for a higher bleeder switch current. Capacitor C1, R6, C2, and R4 work as a bleeder stabilizing network.

Resistor R1 senses the overall input current and feeds this information to U1's BLEEDER CURRENT SENSE (BS) pin through resistor R11. The overall current is the sum of the active bleeder current and the U1 switch current. These currents are sensed in order to keep the TRIAC current above its holding current level by modulating the bleeder current in a closed-loop system.

IC U1 BL pin drives the external bleeder switch in order to maintain the driver input current above the holding current of the TRIAC dimmer.

Thermistor RT1, R26 and Q4 provide a thermal management control for the active bleeder components in case of abnormal conditions such as TRIAC dimmer multi-fire and output short circuit. NTC thermistor RT1 should be kept in close proximity for effective sensing of the temperature of the bleeder resistors and the bleeder switch Q1. The transistor Q4 pulls down the BL pin to reduce bleeder drive once the RT1 resistance drops due to increased temperature.

5 PCB Layout

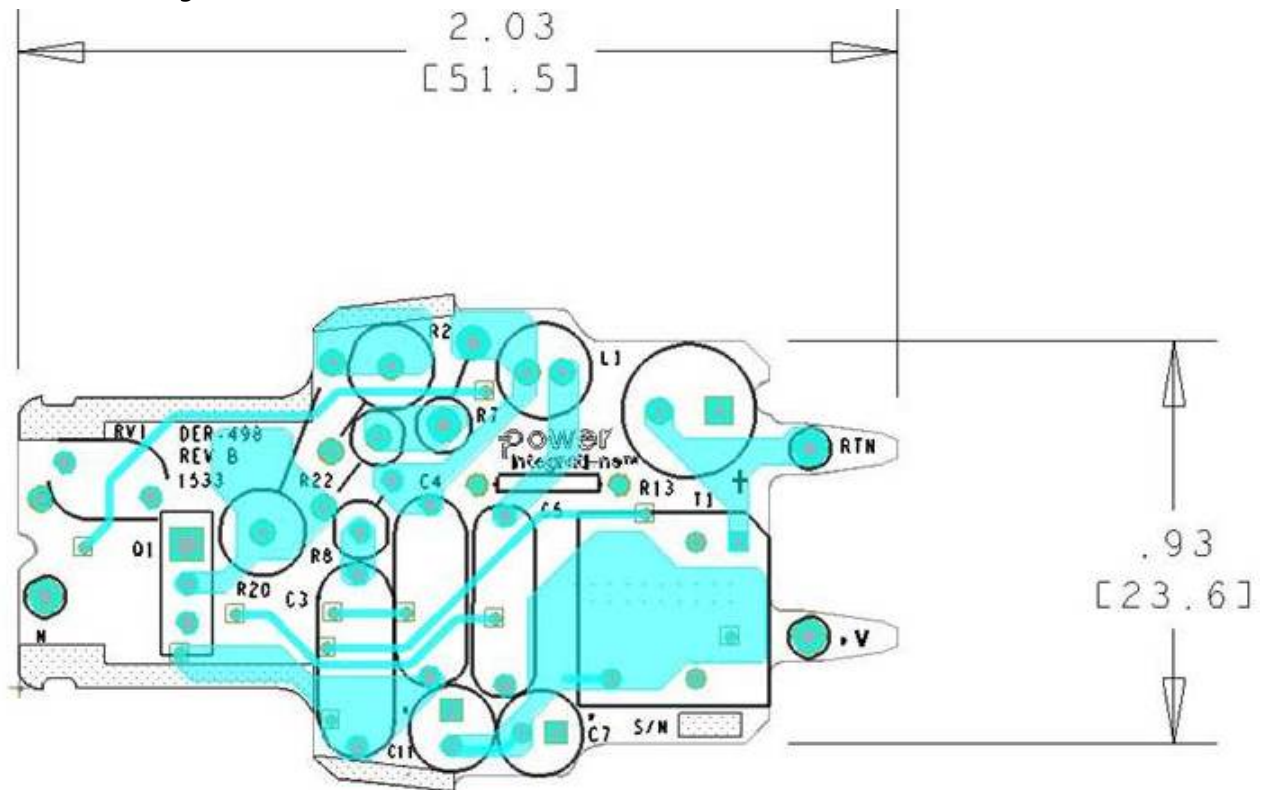

Figure 5 – Top Side.

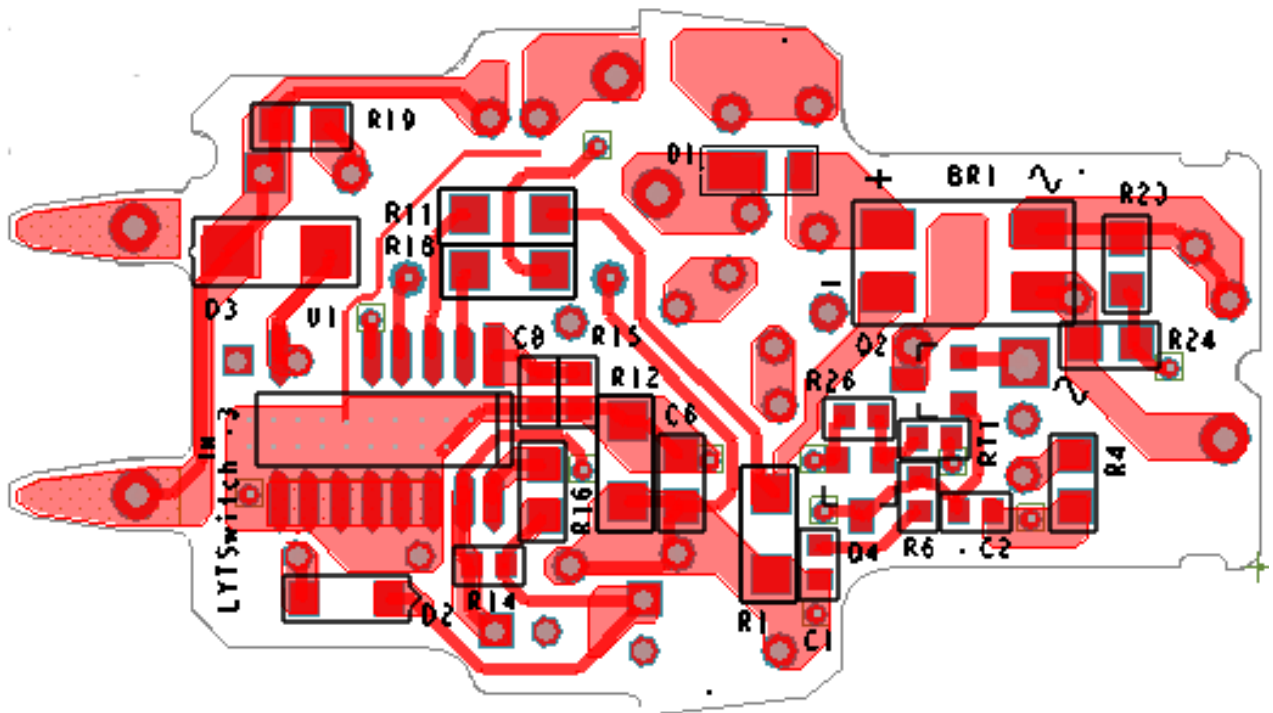

Figure 6 – Bottom Side.



6 Bill of Materials

Item	Ref Des	QTY	Description	Mfg Part Number	Manufacturer
1	BR1	1	1000 V, 0.8 A, Bridge Rectifier, SMD, MBS-1, 4-SOIC	B10S-G	Comchip
2	C1	1	10 nF 50 V, Ceramic, X7R, 0603	C0603C103K5RACTU	Kemet
3	C2	1	4.7 nF 50 V, Ceramic, X7R, 0603	GRM188R71H472KA01D	Murata
4	C3	1	100 nF, 400 V, Film	ECQ-E4104KF	Panasonic
5	C4	1	100 nF, 400 V, Film	ECQ-E4104KF	Panasonic
6	C5	1	33 nF, 400 V, Film	ECQ-E4333KF	Panasonic
7	C6	1	10 μ F, 10 V, Ceramic, X7R, 0805	C2012X7R1A106M	TDK
8	C7	1	22 μ F, 50 V, Electrolytic, Low ESR, 900 m Ω , (5 x 11.5)	ELXZ500ELL220MEB5D	Nippon Chemi-Con
9	C8	1	150 nF, 25 V, Ceramic, X7R, 0603	C1608X7R1E154K080AA	TDK
10	C10	1	120 μ F, 50 V, Electrolytic, Low ESR, 160 m Ω , (8 x 15)	ELXZ500ELL121MH15D	Nippon Chemi-Con
11	C11	1	22 μ F, 50 V, Electrolytic, Low ESR, 900 m Ω , (5 x 11.5)	ELXZ500ELL220MEB5D	Nippon Chemi-Con
12	D1	1	600 V, 1 A, Rectifier, Glass Passivated, POWERDI123	DFLR1600-7	Diodes, Inc.
13	D2	1	250 V, 0.2 A, Fast Switching, 50 ns, SOD-123	BAV21W-7-F	Diodes, Inc.
14	D3	1	DIODE ULTRA FAST, GPP, 400 V, 1A SMA	US1G-13-F	Diodes, Inc.
15	F1	1	FUSE, PICO, FAST, 3A, 250 V, AXIAL	0263003.MXL	Littlefuse
16	L1	1	1 mH, 0.220 A, 10%	RL-5480HC-1-1000	Renco
17	Q1	1	NPN, 450 V, 1.3 A, TO126	APT13003EU-G1DI-ND	Diodes, Inc.
18	Q2	1	NPN, HP, 400 V, 225 mA, SOT23-3	FMMT458TA	Diodes, Inc.
19	Q4	1	NPN, Small Signal BJT, GP SS, 40 V, 0.6 A, SOT-23	MMBT4401LT1G	On Semi
20	R1	1	3.6 Ω , 5%, 1/4 W, Thick Film, 1206	ERJ-8GEYJ3R6V	Panasonic
21	R2	1	2.7 k Ω , 5%, 3 W, Metal Oxide	ERG-3SJ272	Panasonic
22	R4	1	20 Ω , 5%, 1/8 W, Thick Film, 0805	ERJ-6GEYJ200V	Panasonic
23	R6	1	1 k Ω , 5%, 1/10 W, Thick Film, 0603	ERJ-3GEYJ102V	Panasonic
24	R7	1	220 Ω , 5%, 2 W, Metal Oxide Film	ERG-2SJ221	Panasonic
25	R8	1	300 Ω , 5%, 1 W, Metal Oxide	RSF100JB-300R	Yageo
26	R11	1	24 k Ω , 5%, 1/4 W, Thick Film, 1206	ERJ-8GEYJ243V	Panasonic
27	R12	1	7.5 Ω , 1%, 1/4 W, Thick Film, 1206	CRCW12067R50FKEA	Vishay
28	R13	1	6.04 k Ω , 1%, 1/4 W, Metal Film	MFR-25FBF-6K04	Yageo
29	R14	1	4.7 k Ω , 5%, 1/10 W, Thick Film, 0603	ERJ-3GEYJ472V	Panasonic
30	R15	1	37.4 k Ω , 1%, 1/16 W, Thick Film, 0603	ERJ-3EKF3742V	Panasonic
31	R16	1	182 k Ω , 1%, 1/8 W, Thick Film, 0805	ERJ-6ENF1823V	Panasonic
32	R18	1	1 M Ω , 5%, 1/4 W, Thick Film, 1206	ERJ-8GEYJ105V	Panasonic
33	R19	1	18 k Ω , 5%, 1/8 W, Thick Film, 0805	ERJ-6GEYJ183V	Panasonic
34	R20	1	2.4 k Ω , 5%, 3 W, Metal Oxide	ERG-3SJ242	Panasonic
35	R22	1	100 k Ω , 5%, 1/2 W, Carbon Film, Mini	CFM12JT100K	Stackpole
36	R23	1	2 M Ω , 5%, 1/8 W, Thick Film, 0805	ERJ-6GEYJ205V	Panasonic
37	R24	1	2 M Ω , 5%, 1/8 W, Thick Film, 0805	ERJ-6GEYJ205V	Panasonic
38	R26	1	270 Ω , 5%, 1/10 W, Thick Film, 0603	ERJ-3GEYJ271V	Panasonic
39	RT1	1	NTC Thermistor, 220 k Ω , 3%, 0603	NCP18WM224E03RB	Murata
40	RV1	1	430 V, 8.6 J, 5 mm, RADIAL	S05K275	Epcos
41	T1	1	Bobbin, EE10, Vertical, 8 pins	EE-1016	Yulongxin
42	U1	1	LYTSwitch-3, SO-16C	LYT3325D	Power Integrations
Miscellaneous Parts					
1	+V	1	Test Point, RED, Miniature THRU-HOLE MOUNT	5000	Keystone
2	L	1	Test Point, BLK, Miniature THRU-HOLE MOUNT	5001	Keystone
3	N	1	Test Point, WHT, Miniature THRU-HOLE MOUNT	5002	Keystone
4	RTN	1	Test Point, BLK, Miniature THRU-HOLE MOUNT	5001	Keystone



7 Inductor Specification

7.1 Electrical Diagram

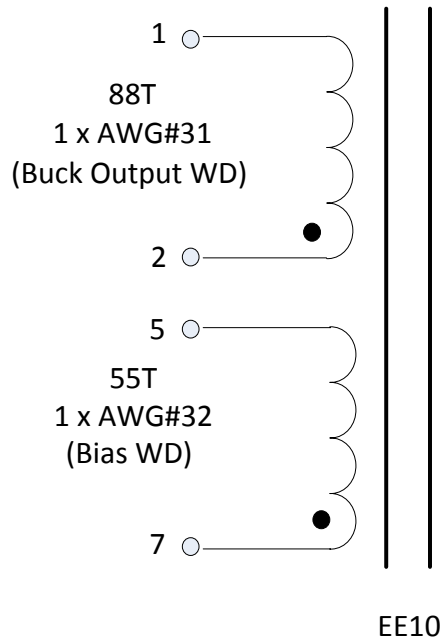

Figure 7 – Inductor Electrical Diagram.

7.2 Electrical Specifications

Parameter	Condition	Spec.
Nominal Primary Inductance	Measured at 1 V_{PK-PK} , 100 kHz switching frequency, between pin 1 and pin 2, with all other windings open.	350 μ H
Tolerance	Tolerance of Primary Inductance.	$\pm 10\%$

7.3 Material List

Item	Description
[1]	Core: EE10.
[2]	Bobbin, EE10, Vertical, 8 pins, (10.2 mm W x 10.4 mm L x 9.7 mm H). Part No: 25-01068-00.
[3]	Magnet Wire: #31 AWG.
[4]	Magnet Wire: #32 AWG.
[5]	Transformer Tape: 6.5 mm.
[6]	Transformer Tape: 4.5 mm.

7.4 Inductor Build Diagram

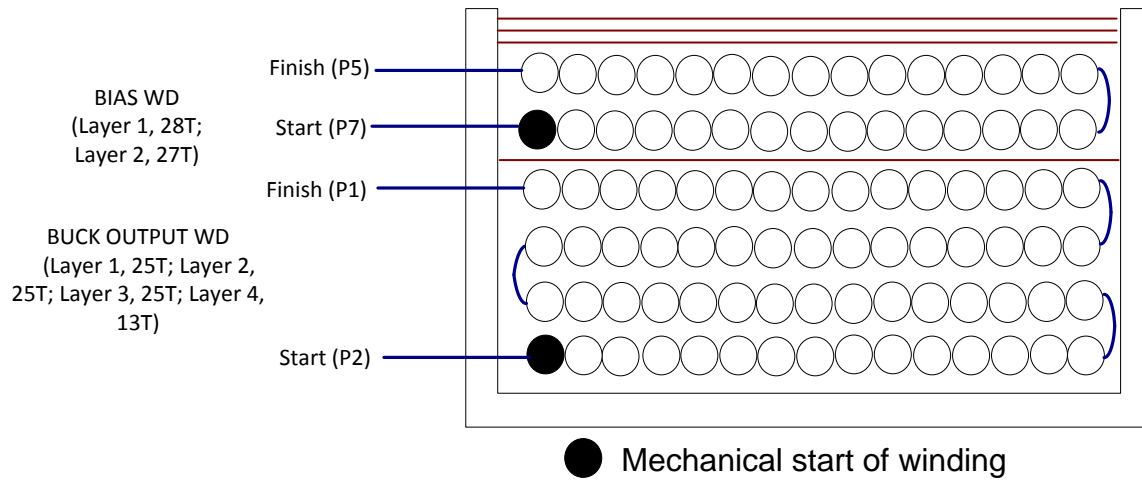

Figure 8 – Transformer Build Diagram.

7.5 Inductor Construction

Winding Directions	Bobbin is oriented on winder jig such that terminal pin 1-4 is at the top left side. The winding direction is counter-clockwise towards the operator.
Winding 1	Use wire item [3], start at pin 2 and wind 88 turns in 4 layers, then finish the winding at pin 1.
Insulation	Add 1 layer of tape, item [5], for insulation.
Winding 2	Use wire item [4], start at pin 7 and wind 55 turns in 2 layers, then finish the winding at pin 5.
Insulation	Add 3 layers of tape, item [5], for insulation.
Core Grinding	Grind the center leg of one core until it meets the nominal inductance of 350 μ H.
Assemble Core	Assemble the 2 cores on the bobbin and wrap with 3 layer of tape, item [6].
Pins	Pull out terminal pin number 3, 4, 6 and 8.
Finish	Dip the transformer assembly in varnish.

7.6 Winding Illustrations

1) Bobbin Preparation

Cut pins 3, 4, 6 and 8.

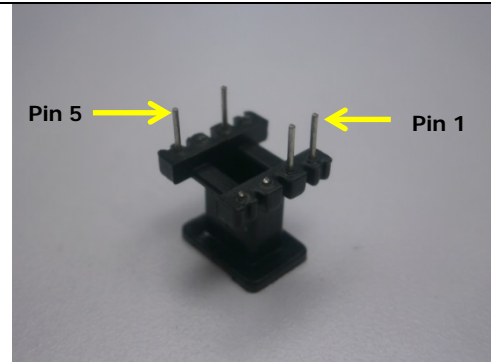

2) Winding Orientation

Bobbin is oriented on the mandrel winder jig such that terminal pin 1-4 is at the left-hand side.

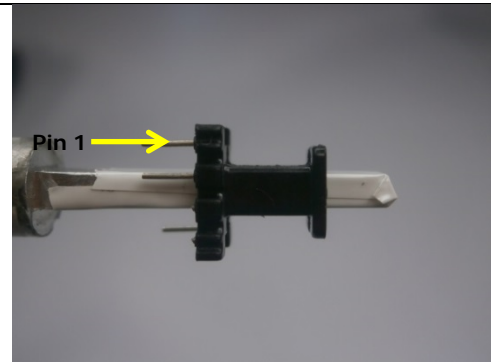

3) Winding Procedure (Main Winding: 1st to 3rd Layer)

Use wire item [3], start at pin 2 and wind 75 turns in 3 layers. The winding direction is counter-clockwise towards the operator. Making 25 turns on each layer from the first up to the third layer. Do not terminate yet. Continue winding as described in the next procedure.

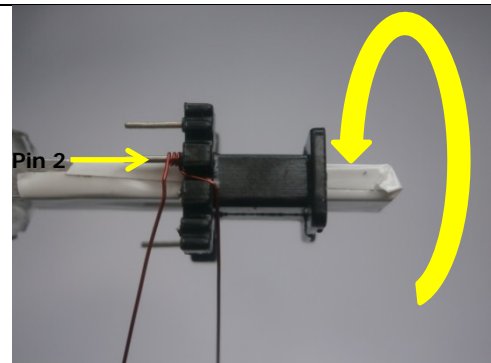

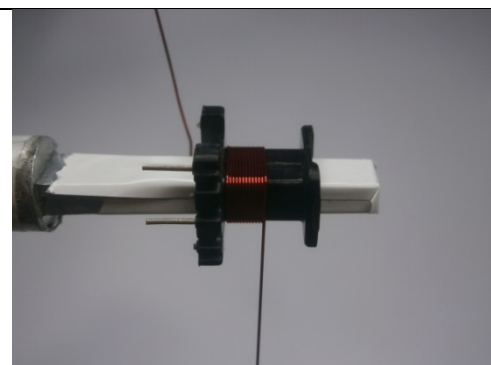

Midway through the 1st layer. Winding turns increment from left to right.

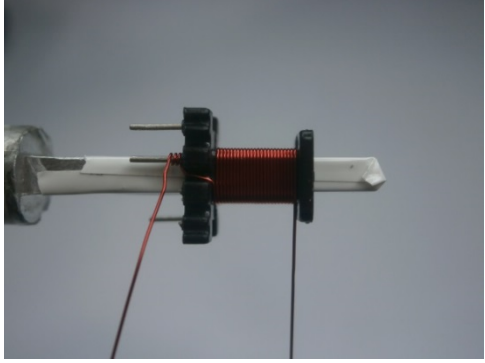
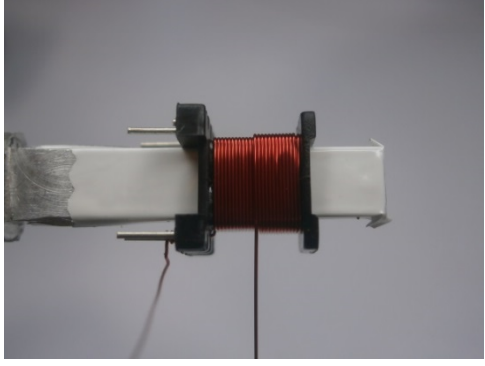
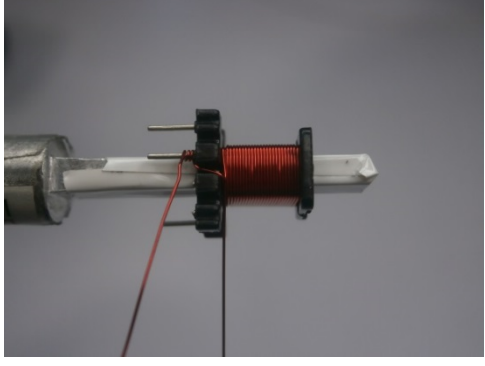
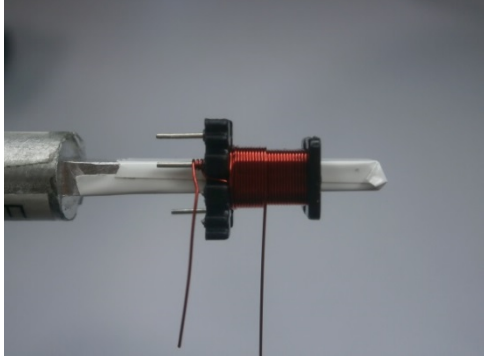

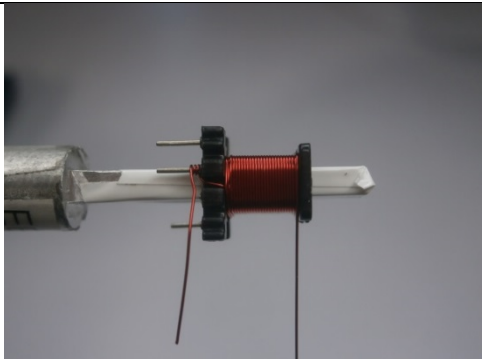
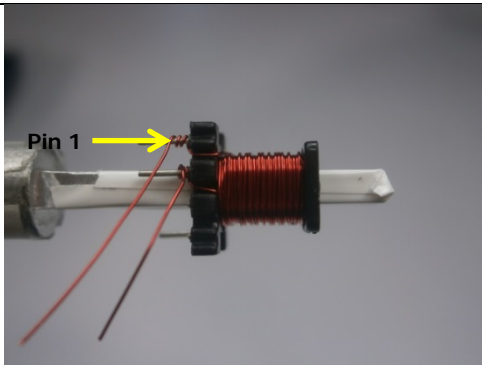
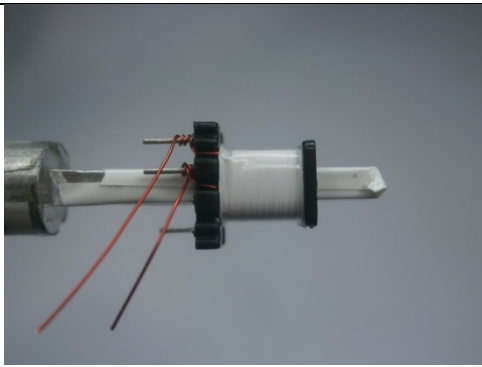
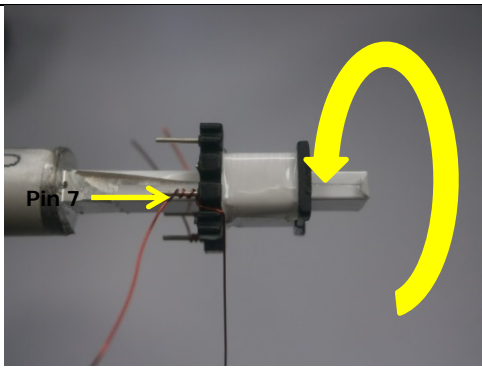
<p>At the end of the 1st layer and beginning of the 2nd layer.</p>	
<p>Midway through the 2nd layer. Winding turns increment from right to left.</p>	
<p>At the end of the 2nd layer and beginning of the 3rd layer.</p>	
<p>Midway through the 3rd layer. Winding turns increment from left to right.</p>	

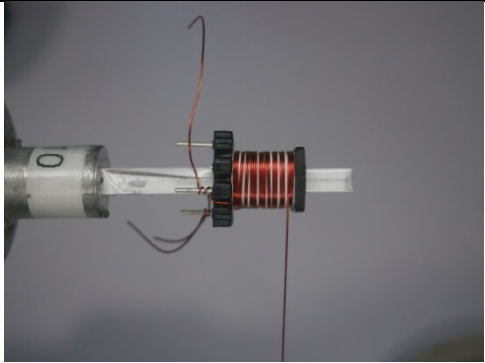
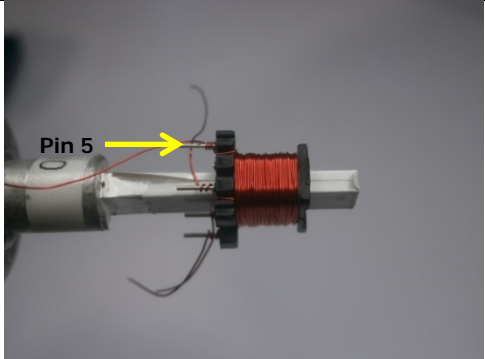
<p>At the end of the 3rd layer and beginning of the 4th layer.</p>	
<p>4) Winding Procedure (Main Winding: 4th Layer)</p> <p>Coming from the previous procedure, for the 4th layer, wind 13 turns on this last layer to complete the 88 turns for the main winding. Evenly distribute the turns along the length of the winding window. Winding turns increment from right to left. Terminate at pin 1.</p>	
<p>5) Insulation</p> <p>Add 1 layer of tape, item [5], for insulation.</p>	
<p>6) Winding Procedure (Bias Winding: 1st Layer)</p> <p>Use wire item [4], start at pin 7 and wind 28 turns in 1 layer. The winding direction is counter-clockwise towards the operator. Winding turns increment from left to right. Evenly distribute the turns along the length of the winding window. Do not terminate yet. Continue winding as described in the next procedure.</p>	

<p>At the end of the 1st layer and beginning of the 2nd layer.</p>	
<p>7) Winding Procedure (Bias Winding: 2nd Layer)</p> <p>Coming from the previous procedure, for the 2nd layer, wind 27 turns on this last layer to complete the 55 turns for the bias winding. Evenly distribute the turns along the length of the winding window. Winding turns increment from right to left. Terminate at pin 5.</p>	
<p>8) Insulation</p> <p>Add 3 layers of tape, item [5], for insulation</p>	
<p>9) Finishing</p> <p>Trim the wires and solder on the terminals.</p>	

Get the EE10 cores and grind it until it reaches the nominal inductance of 350 μH .

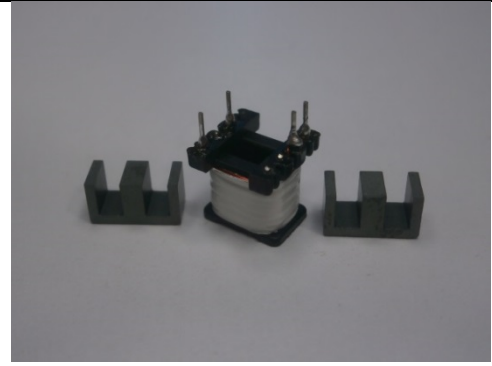

Measure the inductance between terminals 1 and 2. Should be 350 $\mu\text{H} \pm 10\%$.



Assemble the cores onto the bobbin accordingly.

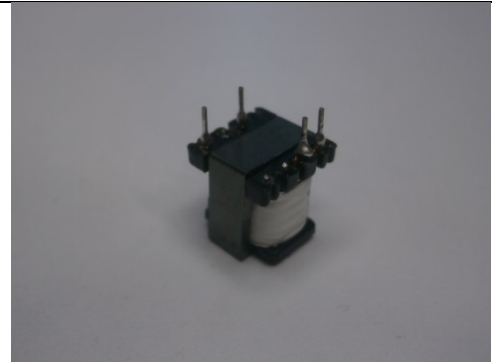

Secure the bobbin with 3 layers of tape, item [6].



10) Varnish

Dip the transformer assembly in varnish.



8 Inductor Design Spreadsheet

ACDC_LYTSwitch-3-Buck_040915; Rev.0.94; Copyright Power Integrations 2015	INPUT	INFO	OUTPUT	UNIT	ACDC_LYTSwitch-3 Buck Design Spreadsheet
ENTER APPLICATION VARIABLES					
VACMIN	185.00		185.00	V	Minimum AC Input Voltage
VACTYP	230.00		230.00	V	Typical AC Input Voltage
VACMAX	265.00		265.00	V	Maximum AC Input Voltage
FL			50.00	Hz	AC Mains Frequency. (between 47Hz and 63Hz)
VOMIN			29.70	V	Minimum Output Voltage of LED string
VO	33.00		33.00	V	Worst case normal operating output voltage
VO_OVP_MIN			40.47	V	Maximum Output Voltage of LED string assuming minimum OC trigger current
IO	150.0		150.0	mA	Average output current specification
n	0.85		0.85		Efficiency Estimate at output terminals. Under 0.7 if no better data available
PO			4.95	W	Continuous Output Power
VD			0.70	V	Output diode forward voltage drop
ENTER LYTSwitch-3 VARIABLES					
Select Breakdown Voltage	650V		650V	V	Choose between 650V and 725V
Device	LYT33X4		LYT33X4		Chosen LYTSwitch-3 device
Final device code			LYT3324		
Select Dimming Curve Option	1		1		Dimming curve 1
RBS2			6.04	k-ohm	RBS2 resistor to select dimming curve
ILIMITMIN			0.84	A	Minimum Current Limit
ILIMITTYP			0.91	A	Typical Current Limit
ILIMITMAX			0.97	A	Maximum Current Limit
TON			1.30	us	Expected on-time of MOSFET at low line and PO
FSW			84.38	kHz	Expected switching frequency at low line and PO
Duty Cycle			10.95	%	Expected operating duty cycle at low line and PO
IRMS			0.11	A	Worst case drain RMS current at VO
IPK			1.07	A	Worst case peak primary current at VO
KDP			1.20		Worst case ratio between off-time of switch and reset time of core, assuming LPTYP
ENTER INDUCTOR CORE/CONSTRUCTION VARIABLES					
Core Type	EE10		EE10		Enter Transformer Core
Core Part Number			PC40EE10-Z		If custom core is used - Enter part number here
Bobbin part number			BE-10-116-CP		Bobbin Part number (if available)
AE			12.10	mm ²	Core Effective Cross Sectional Area
LE			26.10	mm	Core Effective Path Length
AL			850.00	nH/turn ²	Ungapped Core Effective Inductance
BW			6.60	mm	Bobbin Physical Winding Width
INDUCTOR DESIGN PARAMETERS					
LPMIN			315	uH	Minimum Inductance
LPTYP	350		350	uH	Typical inductance
LP_TOLERANCE			10.00	%	Tolerance of the inductance
TURNS_TOTAL	88		88	Turns	Total number of turns
ALG			45.20	nH/turn ²	Gapped Core Effective Inductance
BM			3281	Gauss	Calculated Worst Case Maximum Flux Density (BM < 3300 G)
BP			3511	Gauss	Calculated Worst Case Peak Flux Density (BP < 4200 G) at LPMAX and ILIMITMAX
BAC			1641	Gauss	AC Flux Density for Core Loss Curves (0.5 X Peak to Peak)
LG			0.32	mm	Gap Length (Lg > 0.1 mm)
LAYERS			3.56		Number of Layers

IL_RMS_WORST			0.33	A	Worst case Inductor RMS current
AWG			31		Winding Wire Gauge (Rounded to next smaller standard AWG value)
CM			81	Cmils	Bare conductor effective area in circular mils
CMA			241.70	Cmils/A	Current Density capacity $200 < CMA < 500$
Current Density (J)			8.26	A/mm ²	Inductor Winding Current density ($3.8 < J < 9.75$ A/mm ²)
BIAS SECTION					
URNS_BIAS			55.00	Turns	Number of turns of Bias Winding
VBIAS			20.00	V	Bias Voltage. Always check performance at minimum VO and maximum VAC.
PIVBS			254.23	V	Output Rectifier Maximum Peak Inverse Voltage (calculated at maximum VAC)
CURRENT WAVEFORM SHAPE PARAMETERS					
DMAX			10.95	%	Duty cycle measured at minimum input voltage
Iavg			0.03	A	Input average current measured on the Mosfet at the minimum input voltage
IP			0.85	A	Peak Drain current at minimum input voltage
ISW_RMS			0.11	A	MOSFET RMS current measured at the minimum input voltage
ID_RMS			0.27	A	RMS current of freewheeling diode at minimum input voltage
IL_RMS			0.27	A	RMS current of the of the inductor at the minimum input voltage
FEEDBACK AND BYPASS PIN PARAMETERS					
η _MEASURED			0.85		Measured efficiency value for resistor calculations only
VBIAS_MEASURED			20.00	V	Bias voltage (across the bias capacitor) measured on a prototype unit
VOUT_MEASURED			33.00	V	Load voltage measured on a prototype unit
RDS_T			7.2983	ohm	Theoretical calculation for RDS sense resistor
RDS			7.32	ohm	Rds resistor calculation assuming E96 / 1%
CDS			10.00	uF	Cds capacitor
ROVP			182.00	k-ohm	OC pin resistor (E96 / 1%)
RL			4.02	M-ohm	L pin resistor (E96 / 1%)
RFB_T			37418	ohm	Calculated value of RFB, using RDS_T
RFB			37.40	k-ohm	Feedback pin resistor (E96 / 1%)
CFB_T			160.83	nF	Feedback pin capacitor (for 6ms time constant)
CFB			150	nF	Feedback pin capacitor E12 standard value
RSUP			13.80	k-ohm	Bias supply resistor assuming 1mA current necessary to supply BP
VOLTAGE STRESS PARAMETERS					
VDRAIN			374.77	V	Estimated worst case drain voltage
PIVD			374.77	V	Output Rectifier Maximum Peak Inverse Voltage
BLEEDER COMPONENTS					
I_HOLD			40.00	mA	Required bleeder holding current
RBS1			3.00	Ohm	Exact value of RBS1 resistor

9 Performance Data

All measurements were performed at room temperature using LED string loads. A 2-minute soak time was applied before measurement with the AC source turned off for 5 seconds for every succeeding input line measurement.

9.1 Efficiency

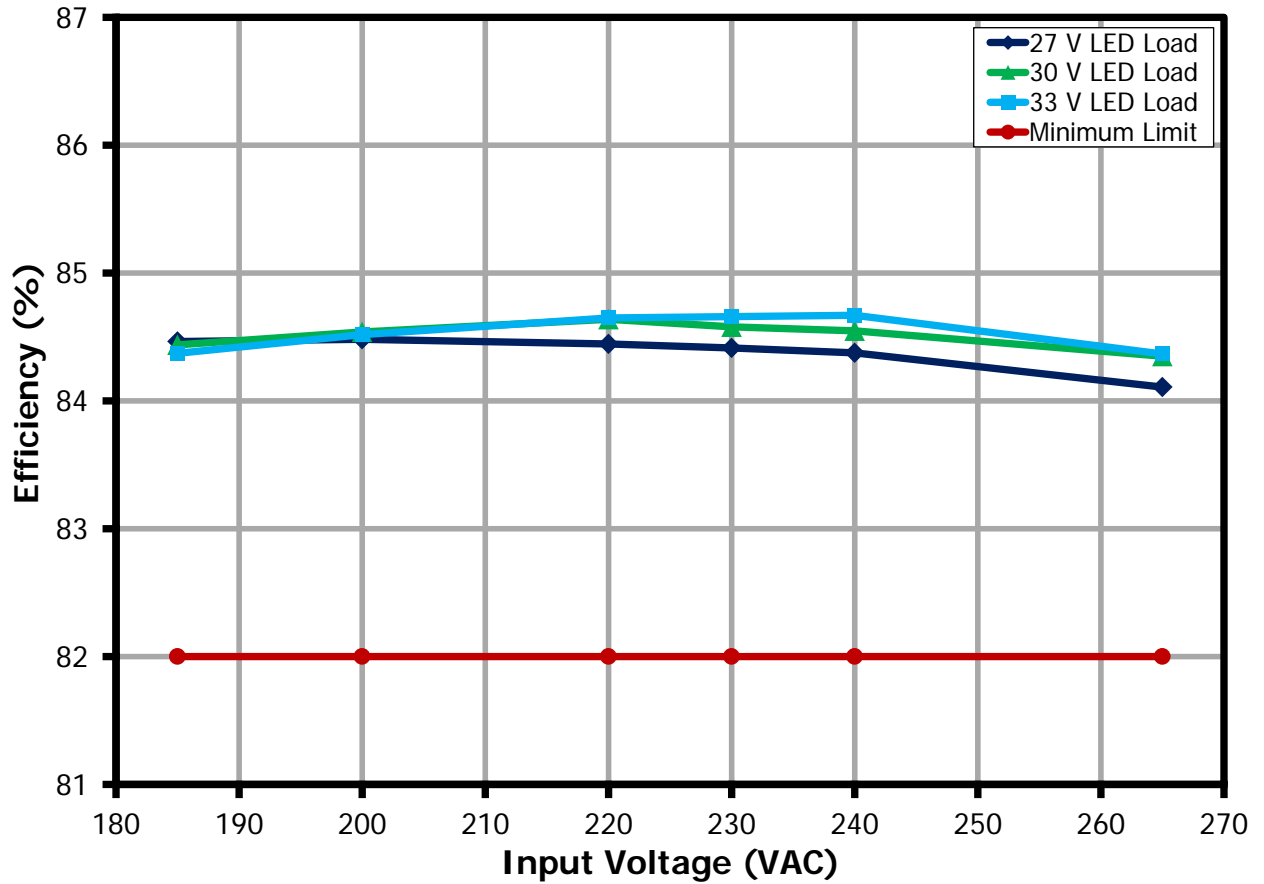

Figure 9 – Efficiency vs. Line and LED Load.



9.2 Line Regulation

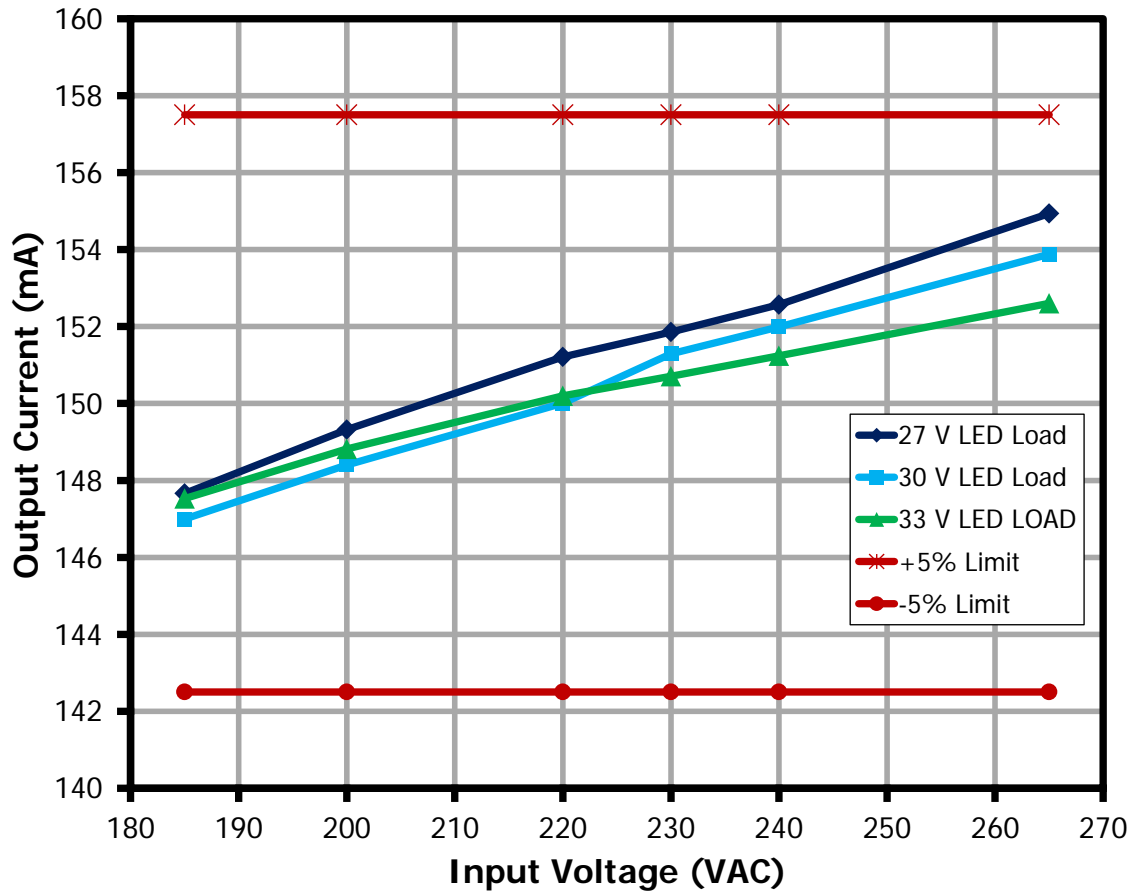

Figure 10 – Regulation vs. Line and LED Load.

9.3 Power Factor

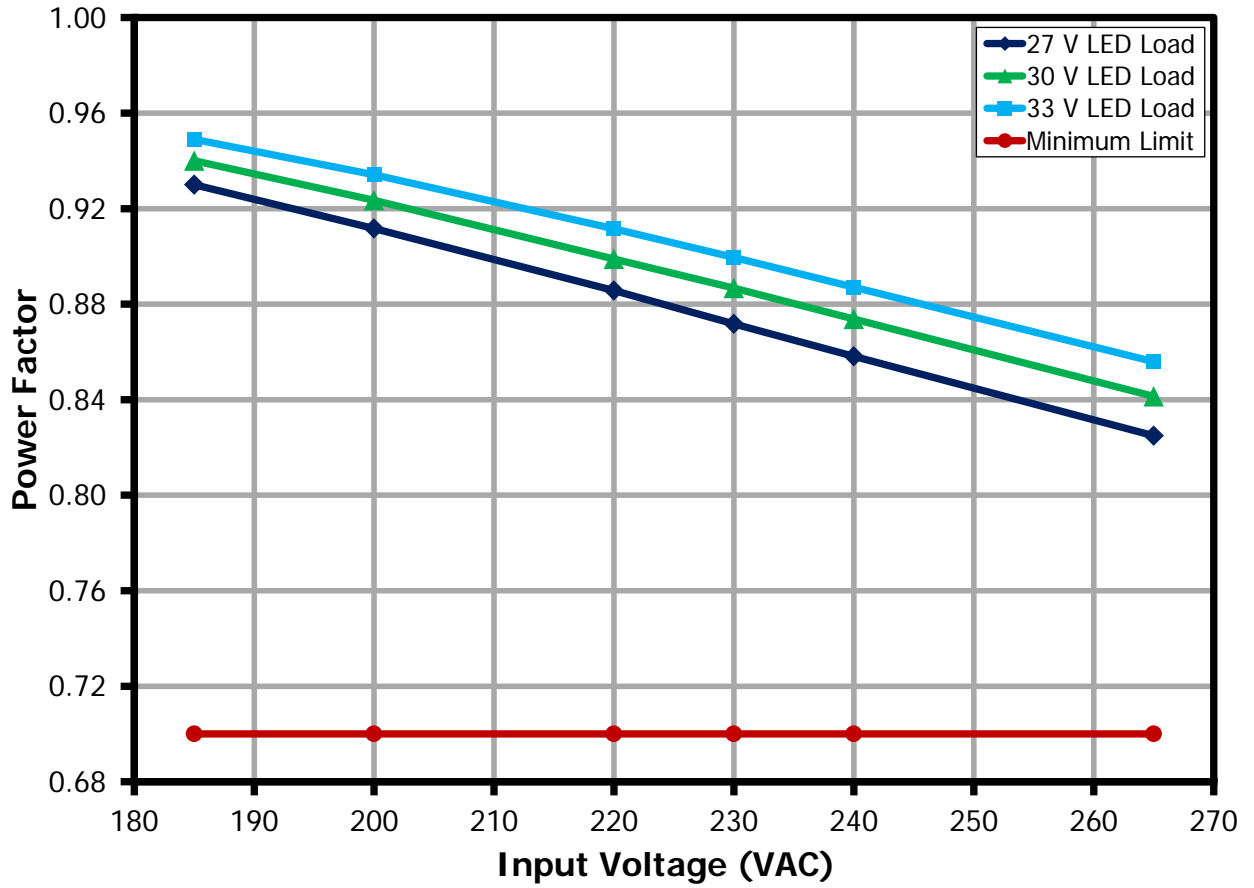

Figure 11 – Power Factor vs. Line and LED Load.



9.4 %ATHD

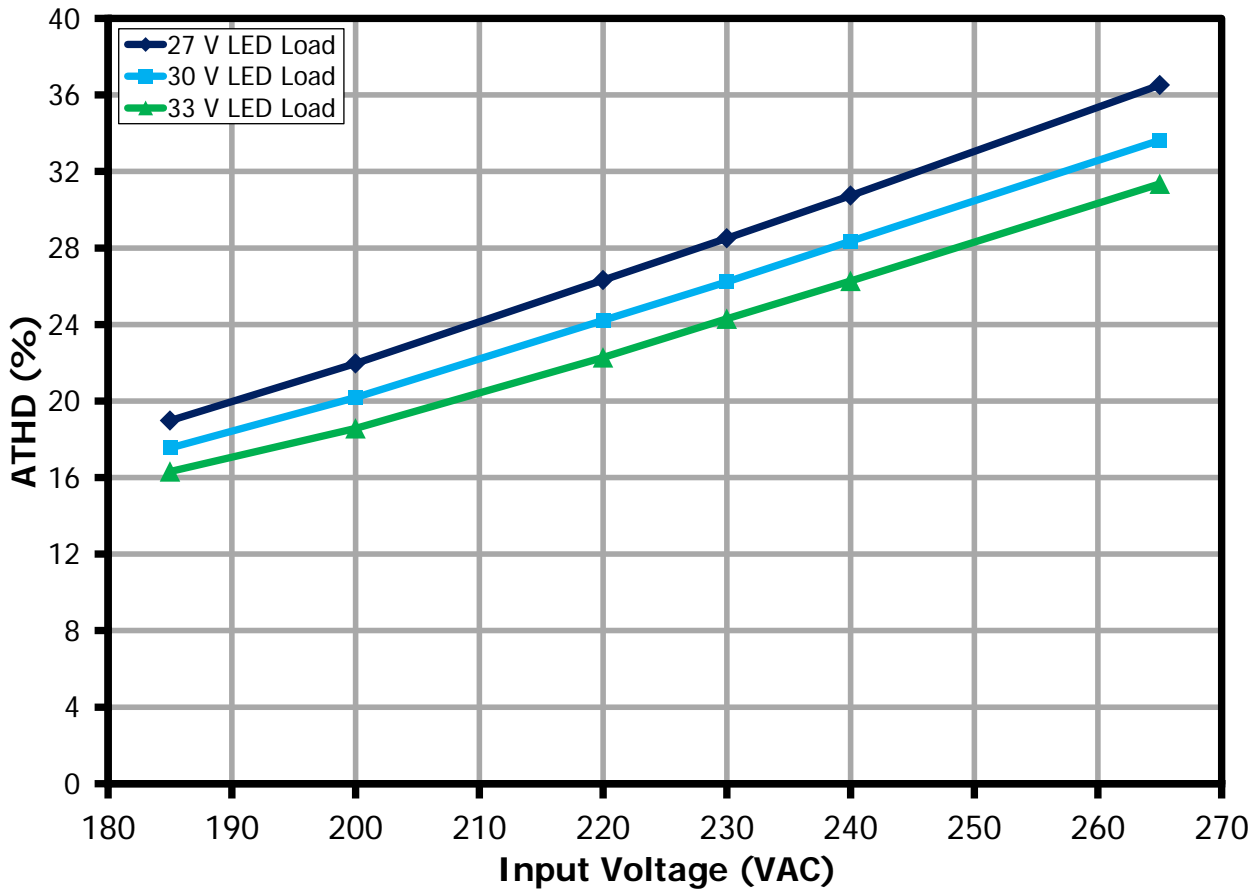

Figure 12 – %ATHD vs. Line and LED Load at 230 VAC, 50 Hz.

9.5 Harmonics

9.5.1 27 V LED Load

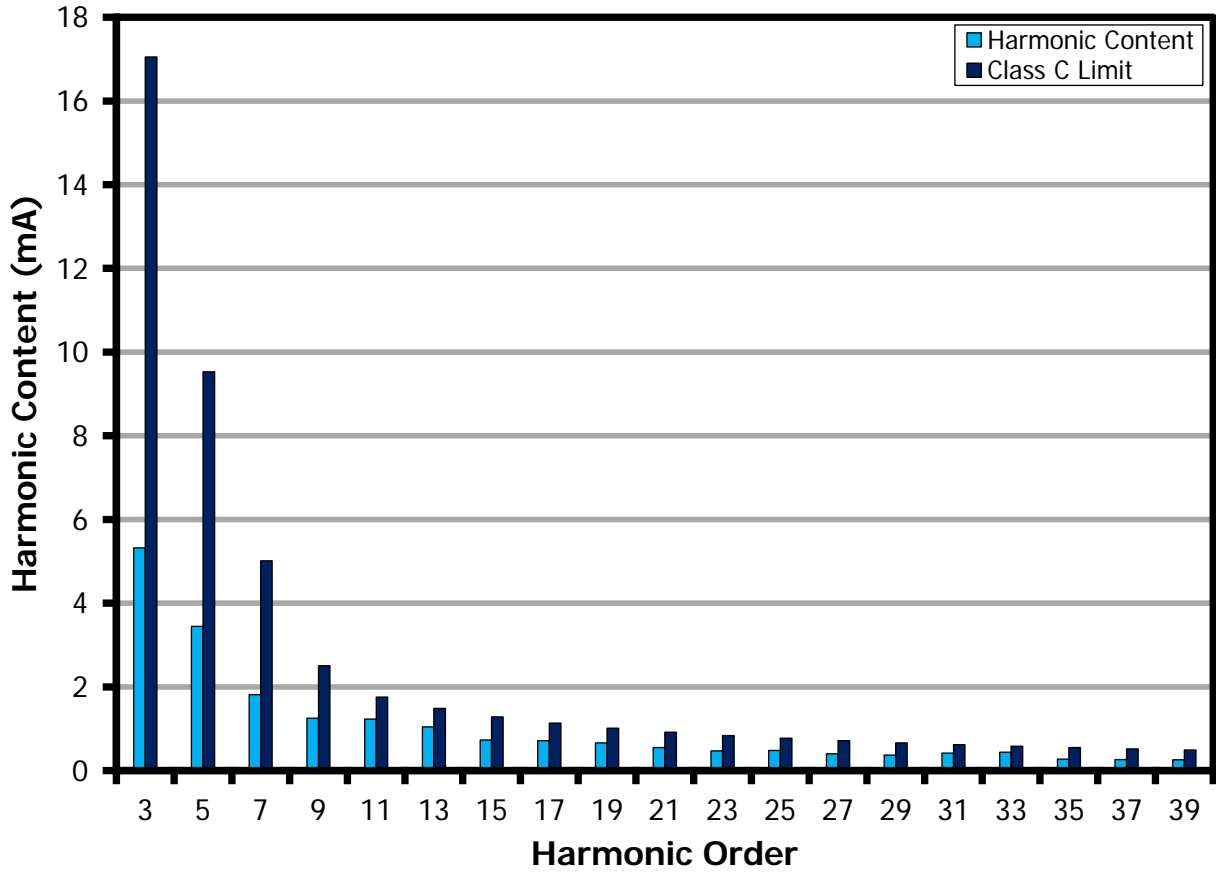

Figure 13 – 27 V LED Load Input Current Harmonics at 230 VAC, 50 Hz.



9.5.2 30 V LED Load

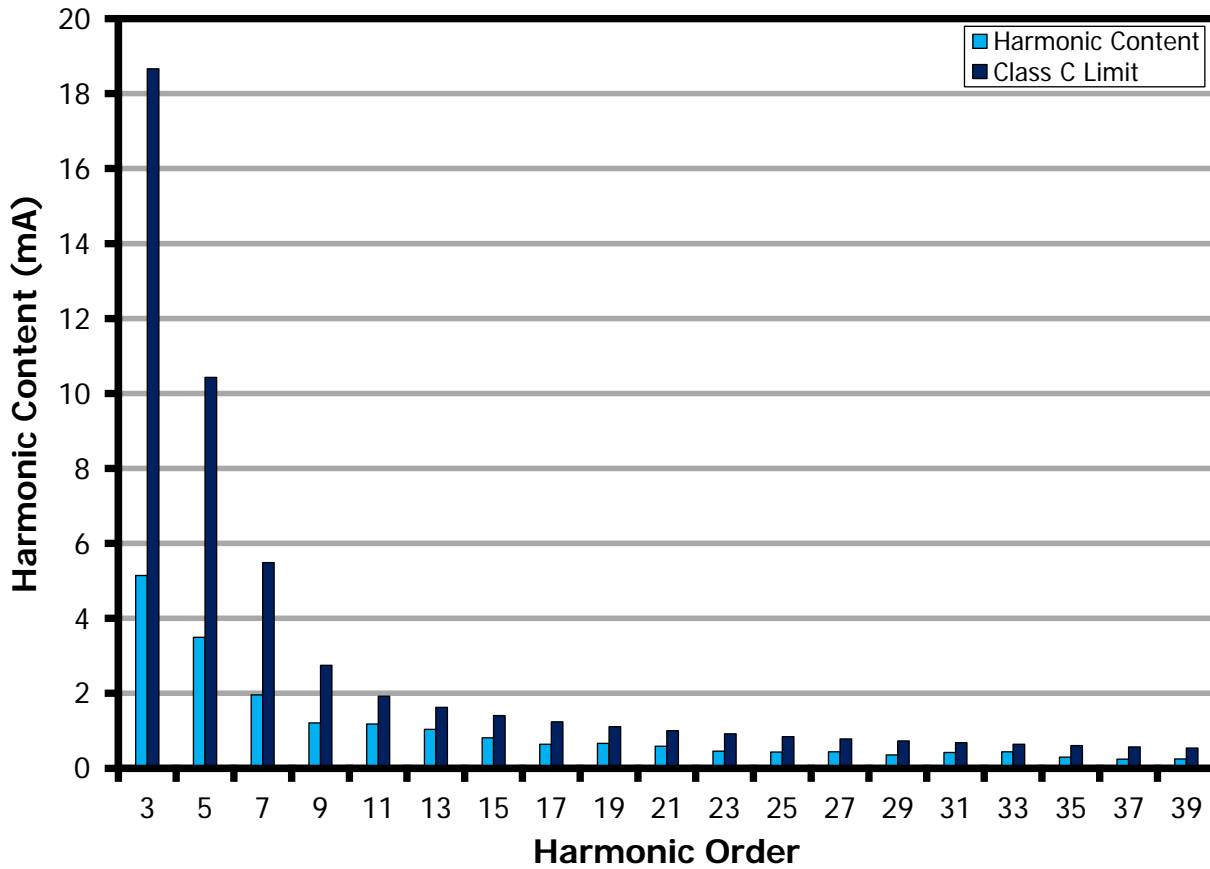

Figure 14 – 30 V LED Load Input Current Harmonics at 230 VAC, 50 Hz.

9.5.3 33 V LED Load

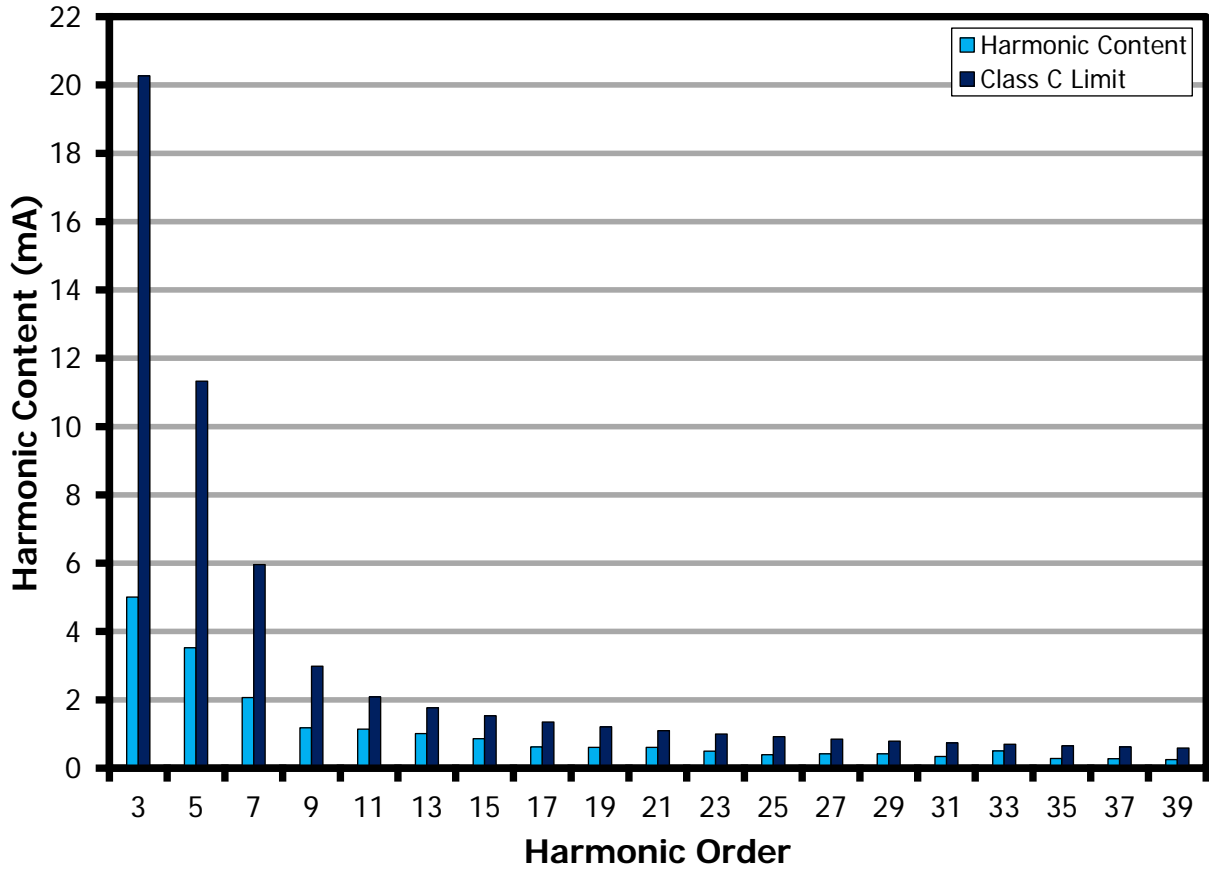

Figure 15 – 33 V LED Load Input Current Harmonics at 230 VAC, 50 Hz.



10 Test Data

10.1 Test Data, 27 V LED Load

Input		Input Measurement					LED Load Measurement			Efficiency (%)
VAC (V _{RMS})	Freq (Hz)	V _{IN} (V _{RMS})	I _{IN} (mA _{RMS})	P _{IN} (W)	PF	%ATHD	V _{OUT} (V _{DC})	I _{OUT} (mA _{DC})	P _{OUT} (W)	
185	50	184.95	28.43	4.89	0.93	18.98	27.59	147.66	4.13	84.46
200	50	199.96	27.12	4.94	0.91	21.96	27.60	149.32	4.18	84.48
220	50	220.00	25.70	5.01	0.89	26.32	27.61	151.21	4.23	84.44
230	50	230.03	25.08	5.03	0.87	28.51	27.62	151.86	4.25	84.41
240	50	239.98	24.55	5.06	0.86	30.74	27.63	152.57	4.27	84.38
265	50	265.02	23.55	5.15	0.82	36.52	27.65	154.94	4.33	84.11

10.2 Test Data, 30 V LED Load

Input		Input Measurement					LED Load Measurement			Efficiency (%)
VAC (V _{RMS})	Freq (Hz)	V _{IN} (V _{RMS})	I _{IN} (mA _{RMS})	P _{IN} (W)	PF	%ATHD	V _{OUT} (V _{DC})	I _{OUT} (mA _{DC})	P _{OUT} (W)	
185	50	184.95	30.77	5.35	0.94	17.55	30.33	147.00	4.52	84.44
200	50	199.95	29.21	5.39	0.92	20.18	30.34	148.40	4.56	84.54
220	50	220.00	27.54	5.45	0.90	24.22	30.35	150.01	4.61	84.64
230	50	230.03	26.94	5.50	0.89	26.23	30.35	151.29	4.65	84.58
240	50	239.98	26.33	5.52	0.87	28.35	30.36	151.99	4.67	84.55
265	50	265.02	25.12	5.60	0.84	33.63	30.38	153.88	4.72	84.35

10.3 Test Data, 33 V LED Load

Input		Input Measurement					LED Load Measurement			Efficiency (%)
VAC (V _{RMS})	Freq (Hz)	V _{IN} (V _{RMS})	I _{IN} (mA _{RMS})	P _{IN} (W)	PF	%ATHD	V _{OUT} (V _{DC})	I _{OUT} (mA _{DC})	P _{OUT} (W)	
185	50	184.95	33.36	5.86	0.95	16.31	33.07	147.53	4.94	84.37
200	50	199.95	31.57	5.90	0.93	18.57	33.08	148.82	4.98	84.52
220	50	220.00	29.62	5.94	0.91	22.28	33.09	150.20	5.03	84.65
230	50	230.03	28.80	5.96	0.90	24.29	33.09	150.71	5.05	84.66
240	50	239.98	28.09	5.98	0.89	26.28	33.10	151.24	5.06	84.67
265	50	265.02	26.69	6.05	0.86	31.36	33.12	152.60	5.11	84.37

10.4 Test Data, Harmonic Content at 230 VAC with 27 V LED Load

V_{IN} (V_{RMS})	Freq	I_{IN} (mA_{RMS})	P_{IN} (W)	PF	%THD
230	50	25.08	5.030	0.872	28.505
nth Order	mA Content	% Content	mA Limit <25 W	% Limit >25 W	Remarks
1	23.94				
2	0.01	0.06%		2.00%	
3	5.32	22.23%	17.05	26.14%	Pass
5	3.45	14.40%	9.53	10.00%	Pass
7	1.82	7.58%	5.02	7.00%	Pass
9	1.26	5.24%	2.51	5.00%	Pass
11	1.23	5.16%	1.76	3.00%	Pass
13	1.04	4.36%	1.49	3.00%	Pass
15	0.73	3.07%	1.29	3.00%	Pass
17	0.72	2.99%	1.14	3.00%	Pass
19	0.66	2.77%	1.02	3.00%	Pass
21	0.55	2.30%	0.92	3.00%	Pass
23	0.47	1.97%	0.84	3.00%	Pass
25	0.48	2.01%	0.77	3.00%	Pass
27	0.41	1.69%	0.72	3.00%	Pass
29	0.37	1.54%	0.67	3.00%	Pass
31	0.42	1.75%	0.62	3.00%	Pass
33	0.44	1.84%	0.59	3.00%	Pass
35	0.28	1.15%	0.55	3.00%	Pass
37	0.27	1.11%	0.52	3.00%	Pass
39	0.26	1.08%	0.50	3.00%	Pass

10.5 Test Data, Harmonic Content at 230 VAC with 30 V LED Load

V_{IN} (V_{RMS})	Freq	I_{IN} (mA_{RMS})	P_{IN} (W)	PF	%THD
230	50	26.94	5.495	0.887	26.231
nth Order	mA Content	% Content	mA Limit <25 W	% Limit >25 W	Remarks
1	25.96				
2	0.03	0.11%		2.00%	
3	5.14	19.81%	18.66	26.60%	Pass
5	3.50	13.47%	10.43	10.00%	Pass
7	1.96	7.55%	5.49	7.00%	Pass
9	1.21	4.67%	2.74	5.00%	Pass
11	1.18	4.55%	1.92	3.00%	Pass
13	1.04	4.00%	1.63	3.00%	Pass
15	0.81	3.13%	1.41	3.00%	Pass
17	0.64	2.46%	1.24	3.00%	Pass
19	0.67	2.57%	1.11	3.00%	Pass
21	0.59	2.27%	1.01	3.00%	Pass
23	0.46	1.76%	0.92	3.00%	Pass
25	0.43	1.66%	0.85	3.00%	Pass
27	0.44	1.69%	0.78	3.00%	Pass
29	0.36	1.38%	0.73	3.00%	Pass
31	0.43	1.64%	0.68	3.00%	Pass
33	0.44	1.68%	0.64	3.00%	Pass
35	0.30	1.15%	0.60	3.00%	Pass
37	0.25	0.94%	0.57	3.00%	Pass
39	0.25	0.96%	0.54	3.00%	Pass

10.6 Test Data, Harmonic Content at 230 VAC with 33 V LED Load

V_{IN} (V_{RMS})	Freq	I_{IN} (mA_{RMS})	P_{IN} (W)	PF	%THD
230	50	28.80	5.960	0.900	24.293
nth Order	mA Content	% Content	mA Limit <25 W	% Limit >25 W	Remarks
1	27.93				
2	0.01	0.04%		2.00%	
3	5.01	17.93%	20.27	26.99%	Pass
5	3.52	12.62%	11.33	10.00%	Pass
7	2.07	7.40%	5.96	7.00%	Pass
9	1.18	4.23%	2.98	5.00%	Pass
11	1.14	4.10%	2.09	3.00%	Pass
13	1.01	3.61%	1.77	3.00%	Pass
15	0.86	3.09%	1.53	3.00%	Pass
17	0.62	2.22%	1.35	3.00%	Pass
19	0.61	2.18%	1.21	3.00%	Pass
21	0.61	2.18%	1.09	3.00%	Pass
23	0.50	1.79%	1.00	3.00%	Pass
25	0.39	1.41%	0.92	3.00%	Pass
27	0.42	1.49%	0.85	3.00%	Pass
29	0.42	1.49%	0.79	3.00%	Pass
31	0.34	1.21%	0.74	3.00%	Pass
33	0.50	1.80%	0.70	3.00%	Pass
35	0.28	1.01%	0.66	3.00%	Pass
37	0.28	0.98%	0.62	3.00%	Pass
39	0.25	0.89%	0.59	3.00%	Pass

11 Dimming Performance Data

TRIAC dimming results were taken at an input voltage of 230 VAC, 50 Hz line frequency, room temperature, and a nominal 30 V LED load. The step is 1° per step and the delay in every step is 45s.

11.1 Dimming Curve

Agilent 6812B AC source programmed as perfect leading edge dimmer.

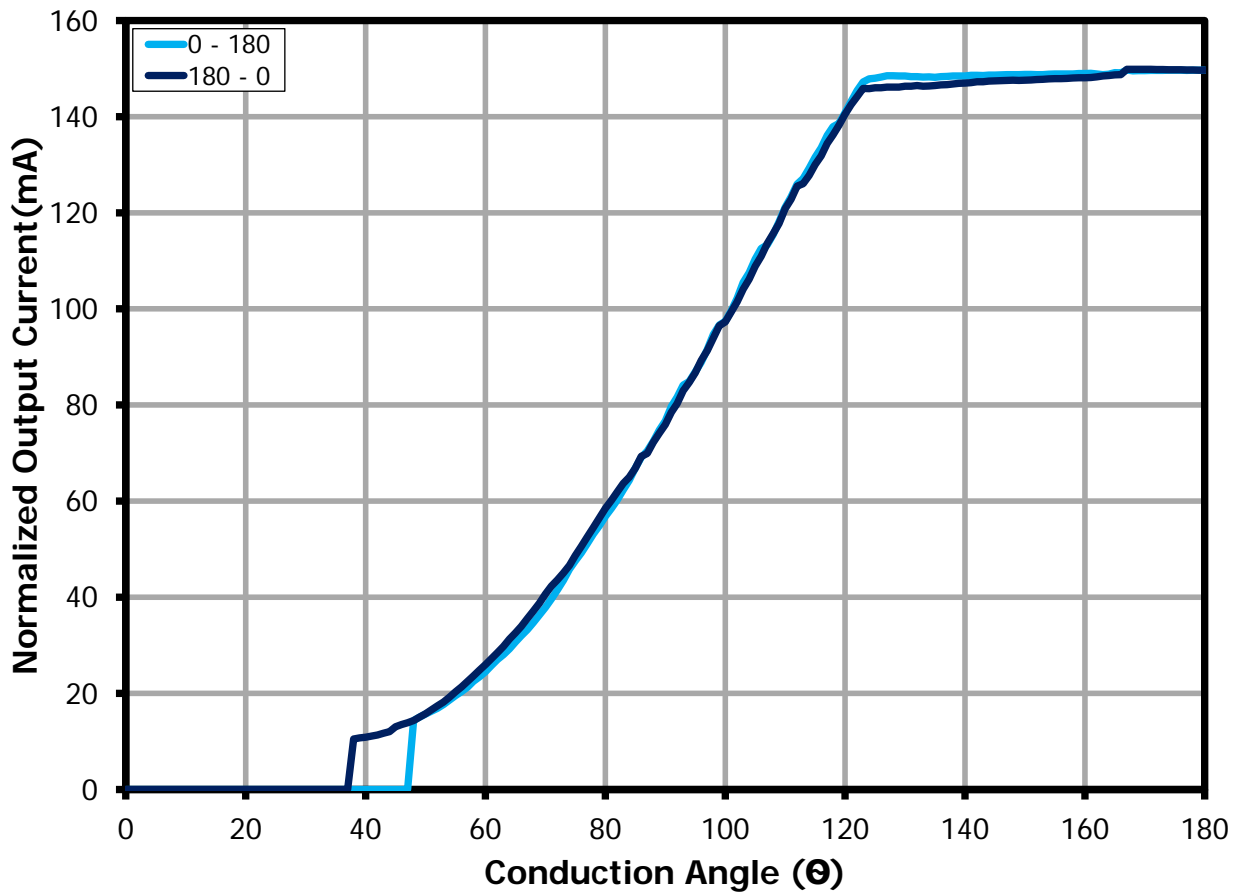

Figure 16 – Dimming Curve at 230 VAC, 50 Hz Input.

11.2 Dimming Efficiency

Measurements were made using a programmable AC source to provide the leading edge chopped AC input. For this test, the bleeder is already active.

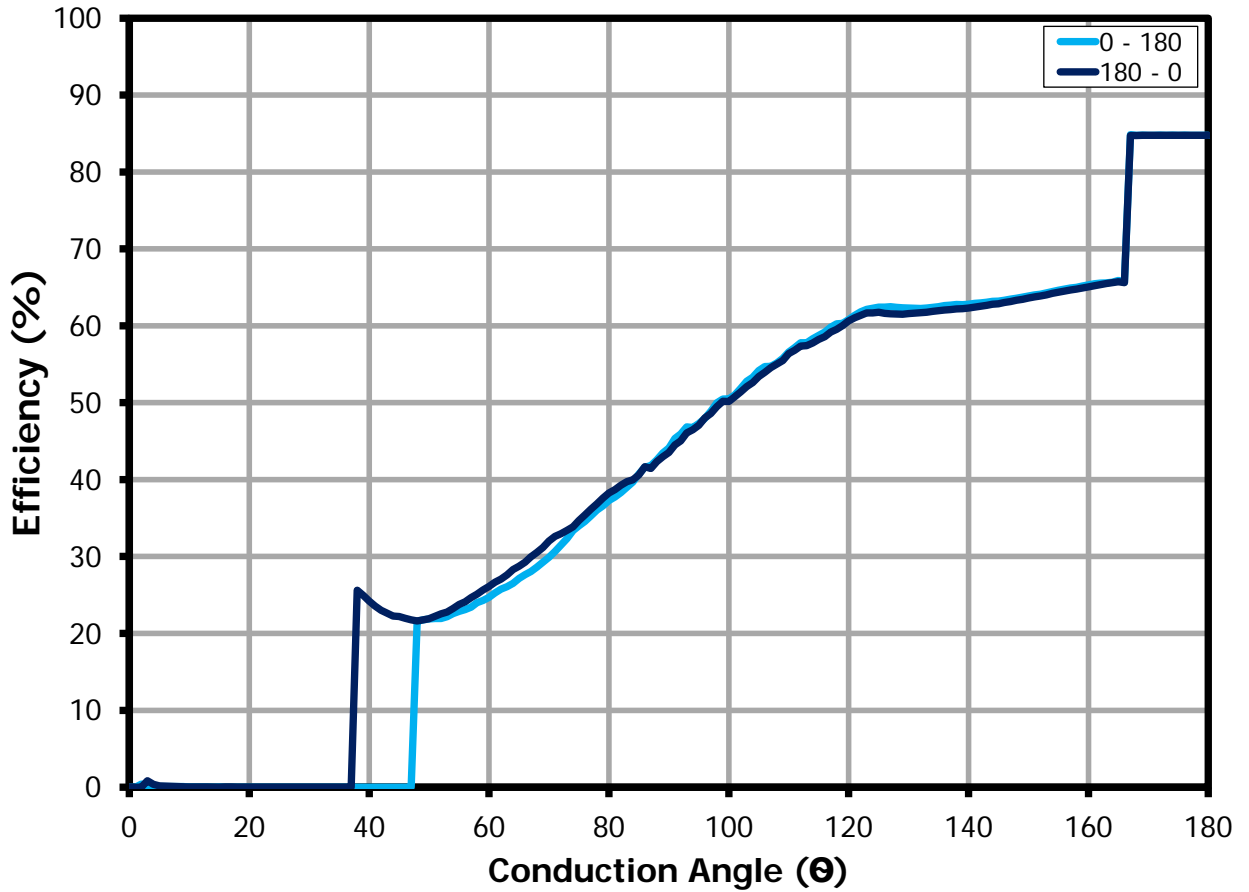

Figure 17 – Driver Efficiency at 230 VAC, 50 Hz Input.



11.3 Driver Power Loss During Dimming

Measurements were made using a programmable AC source to provide the leading-edge chopped AC input. For this test, the bleeder is already active.

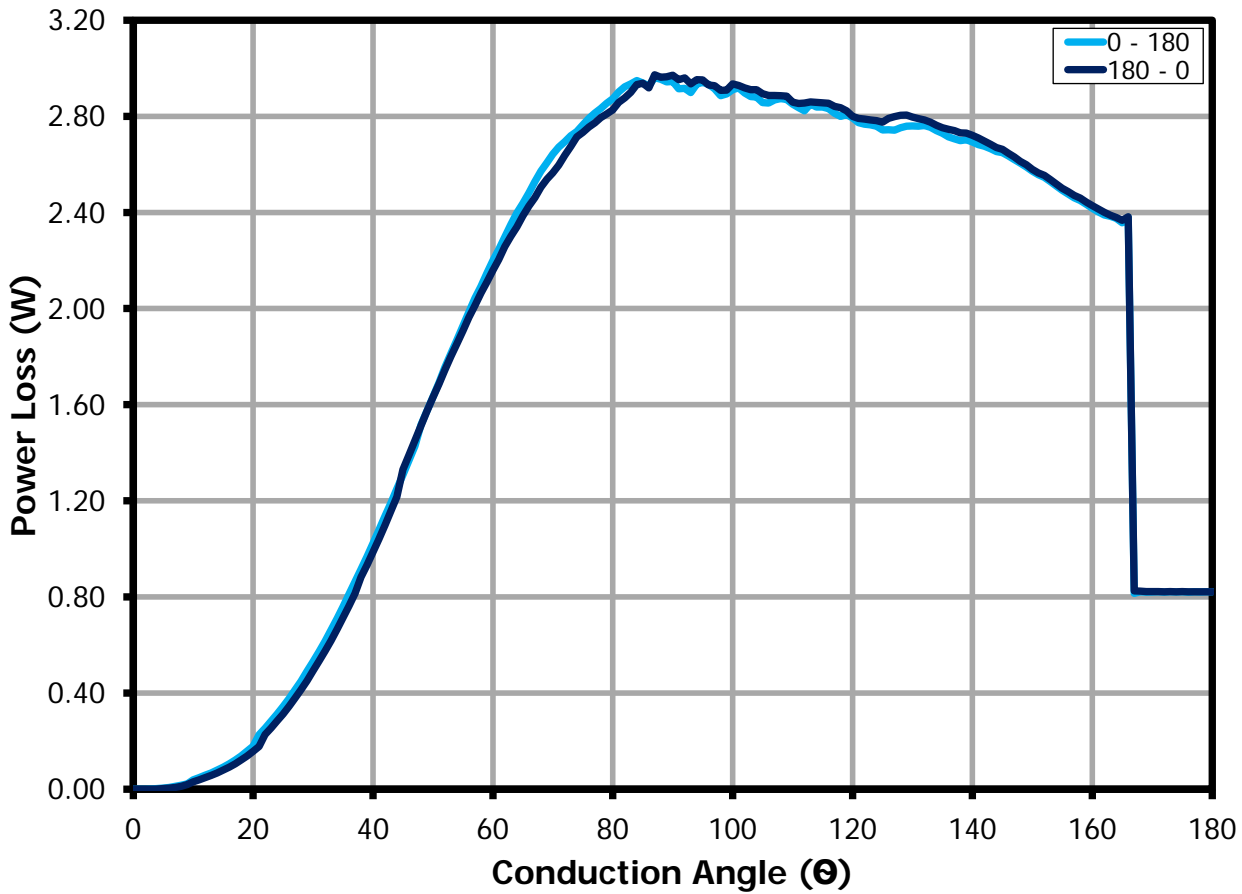

Figure 18 – Driver Power Loss at 230 VAC, 50 Hz Input.

11.4 *Driver Compatibility List*

The following dimmers were tested at 40 °C ambient temperature, programmable AC source input (~230 VAC, 50 Hz) and 30 V LED load (a Philips 12.5 W E27 220-240 V LED bulb cool daylight converted into a 30V LED load).

#	Brand	Model	Type	Max. (mA)	Min. (mA)	Pop-on / Deadband	Dimming Ratio
1	BERKER	2875	L	149.73	14.00	12.64	11
2	GIRA	0307 00 I02	T	159.19	26.00	22.50	6
3	GIRA	1176 00 I03	T	158.50	33.50	31.00	5
4	GIRA	0302 00 I01	L	148.56	14.79	11.22	10
5	GIRA	2262 00	L	149.43	0.21	0.18	712
6	PEHA	433 HAB 0A	T	159.83	25.10	14.70	6
7	JUNG	225 TDE	T	160.00	26.17	22.40	6
8	JUNG	266 GDE	L	147.20	14.18	11.00	10
9	JUNG	225 NVDE	L	146.89	0.18	0.01	834
10	JUNG	254 UDIE 1	T	162.14	31.74	32.14	5
11	BUSCH	2247 U	L	149.64	15.73	0.02	10
12	NIKO	310-01600	L	149.00	17.22	0.44	9
13	NIKO	310-01700	T	159.00	36.00	31.90	4
14	NIKO	310-01400	L	149.00	16.70	13.50	9
15	LEGRAND	048871-665114	T	163.88	22.20	34.70	7
16	GIRA	1176 00 I04	L	152.49	34.88	32.53	4
17	Schneider	ALB45192	L	149.45	10.43	9.96	14
18	RELCO	RTM 34LED DAX B	L	148.30	0.02	0.02	7415
19	EagleRise	SED200LRS	L	150.68	11.20	2.80	13
20	IKEA	EED200LRS	L	150.57	11.00	8.70	14
21	OMNI	WDM-501	L	151.63	38.26	29.76	4

12 Thermal Performance

Thermal measurements were performed with the power supply operating at 40 °C ambient temperature with a 30 V LED load. A Philips 12.5 W E27 220 V - 240 V LED bulb cool daylight was used as the bulb enclosure.

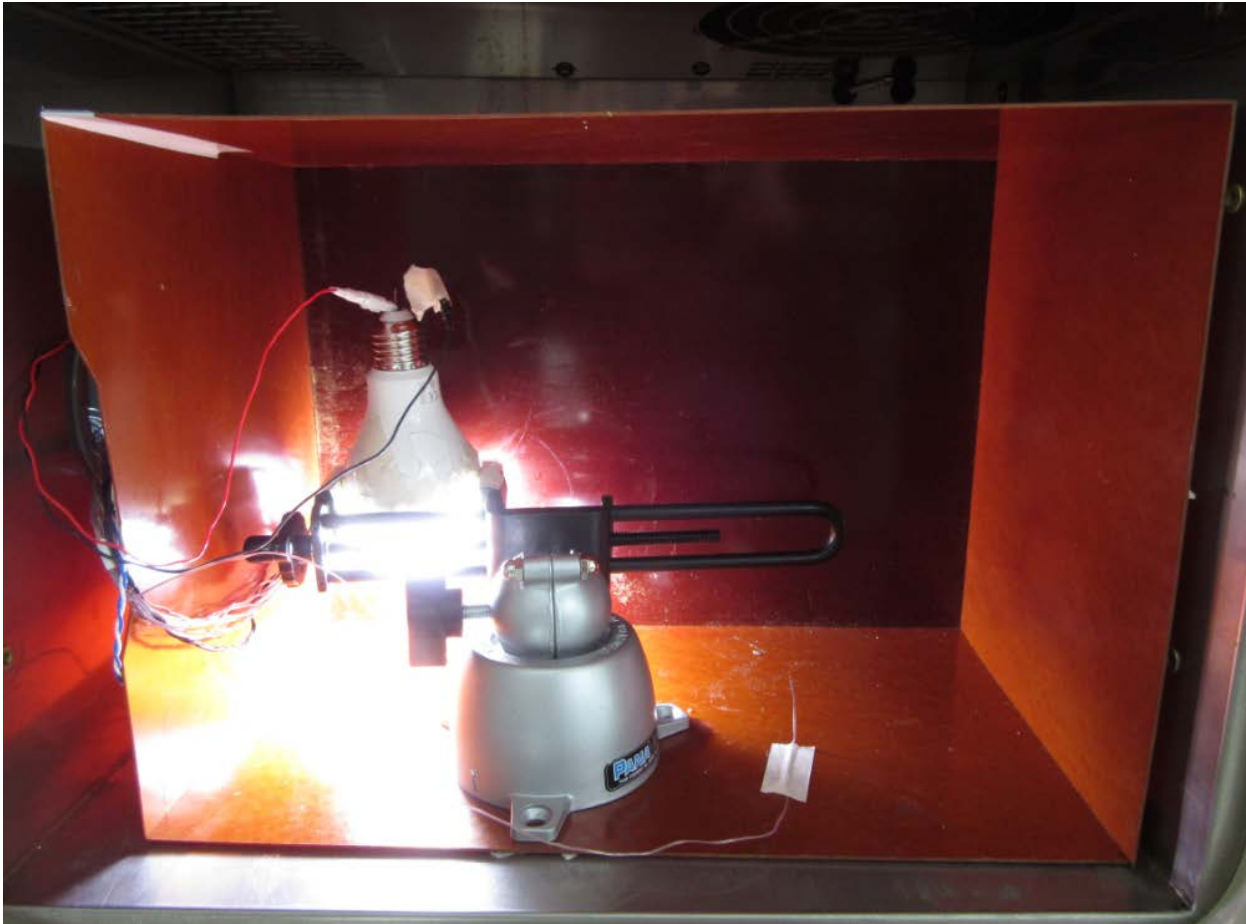
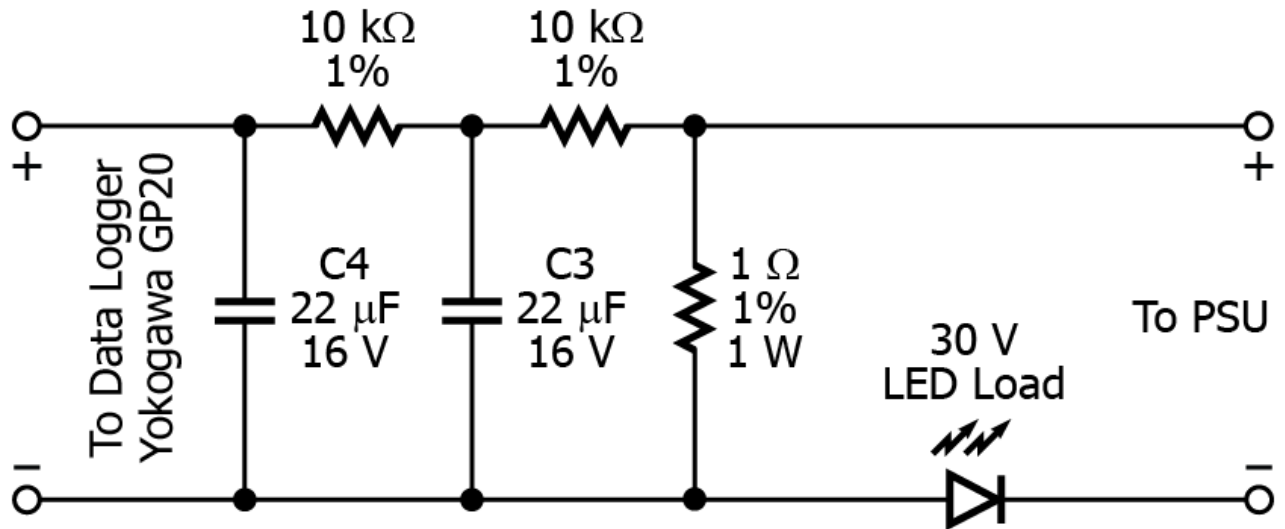

Figure 19 – Set-up Picture.

Unit was placed inside the box enclosure to prevent airflow (cover was removed to take this picture). Chamber temperature set at 40 °C. The thermocouple probe that measures the chamber temperature was placed inside the enclosure about 8 inches away from the LED bulb. There was also a thermocouple probe inside the LED bulb that measures the internal ambient temperature. This thermocouple was placed at the bottom of the LED bulb about 2 cm from the back of the LED plate.



PI-7933-040516

Figure 20 – External interface circuit to measure the output current. All thermal measurements with output current data use this diagram excluding the power meter connection.

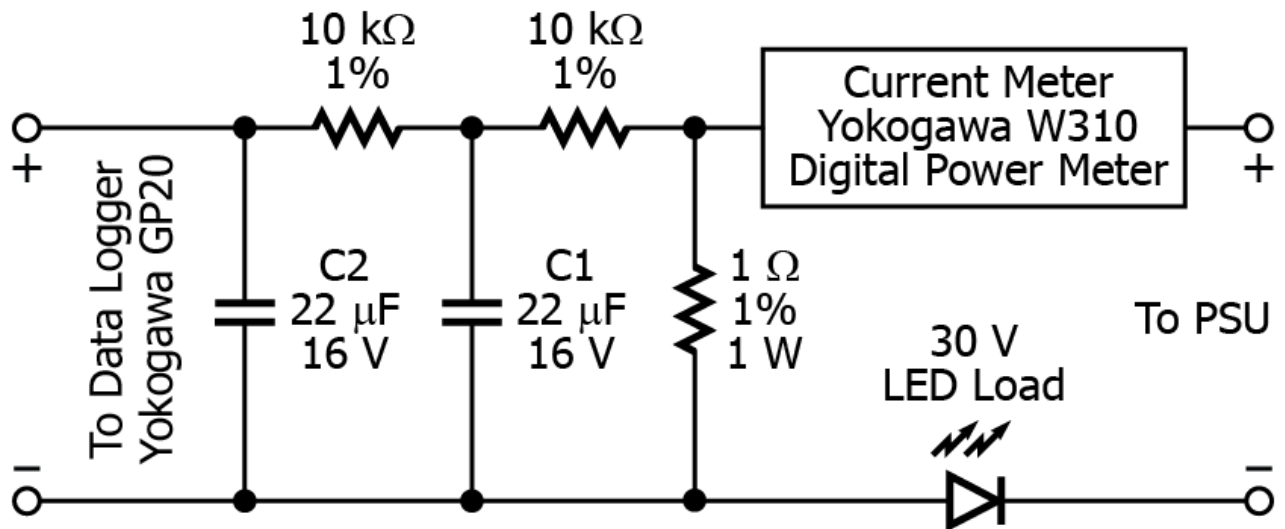

PI-7934-040516

Figure 21 – External interface circuit to measure the output current. This connection diagram was used in the 10-hour burn-in test.



12.1 Non-Dimming Thermal Performance at 185 VAC with a 30 V LED Load

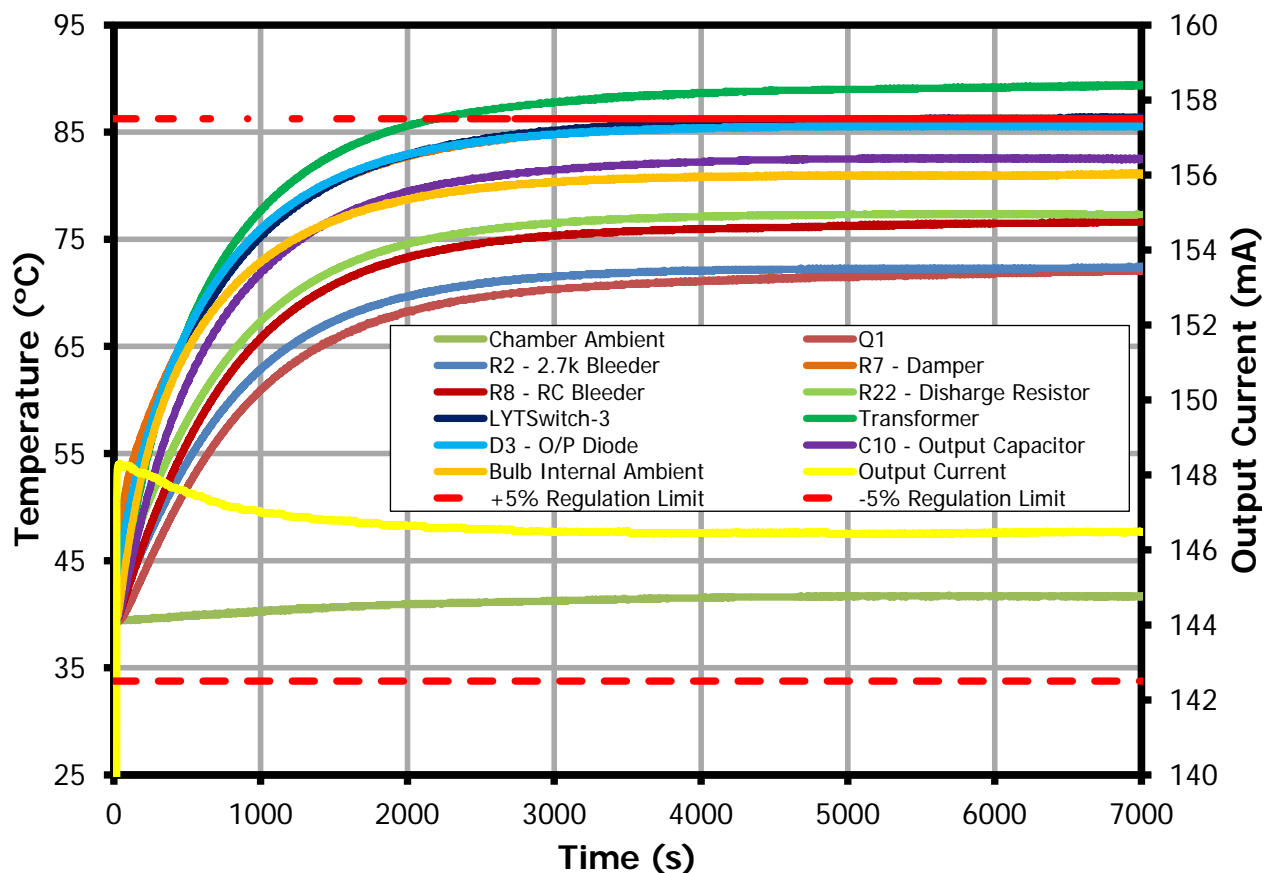

Figure 22 – Component Temperature at 185 VAC, 40 °C Ambient.

Thermal Measurement (°C)	Chamber Temperature	Q1	Bleeder R2	Damper R7	Passive Bleeder R8	Discharge Resistor R22
Peak Measurement	41.8	72.2	73.1	86.4	77.2	77.4
Final Stabilized Value	41.3	72.1	72.9	86.2	77.1	77.4
Thermal Measurement (°C)	LYTSwitch-3 U1	Transformer	D3	Output Capacitor C10	Output Current mA	Bulb Internal Ambient
Peak Measurement	86.4	89.8	86	82.6	148.3	82.1
Final Stabilized Value	86	89.8	85.9	82	146.45	82



12.2 Non-Dimming Thermal Performance at 230 VAC with a 30 V LED Load

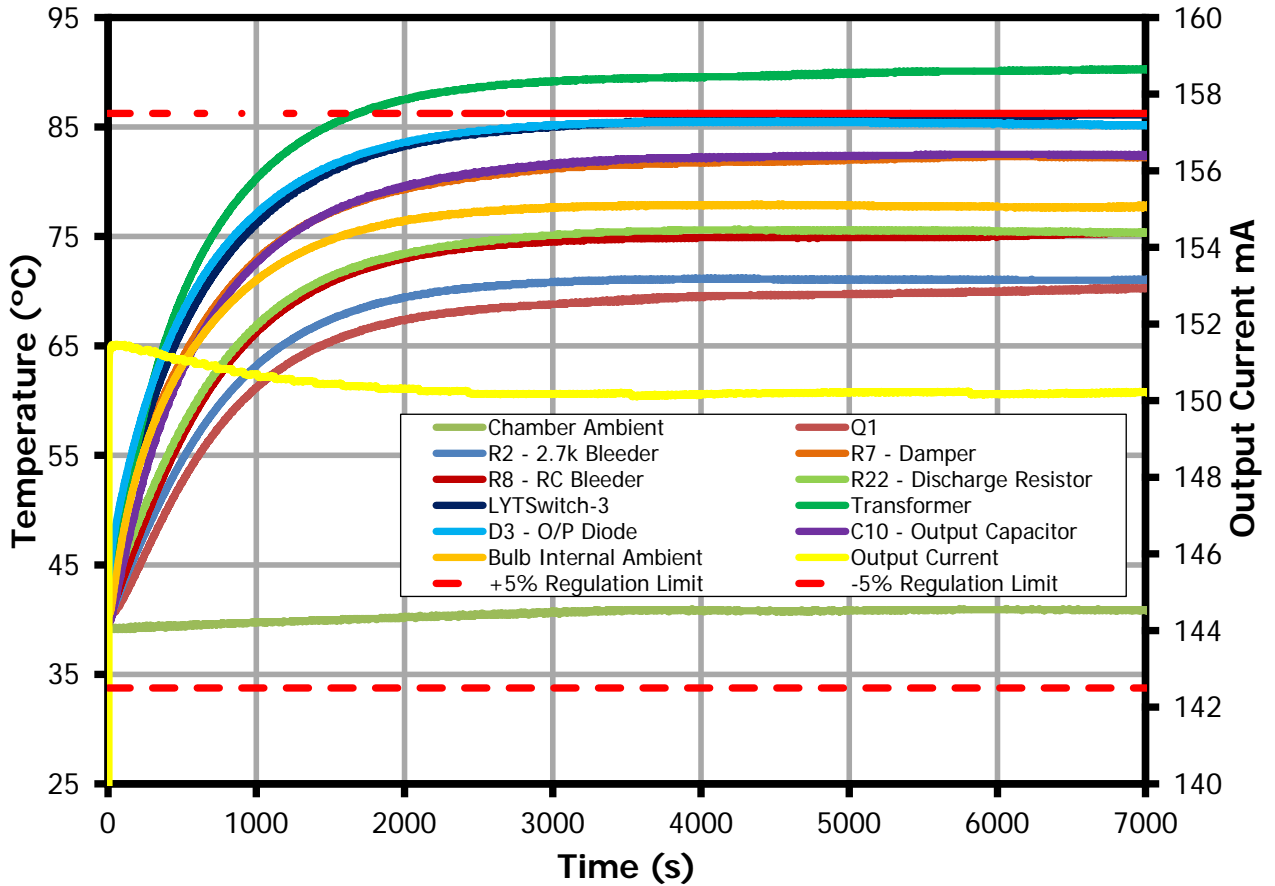

Figure 23 – Component Temperature at 230 VAC, 40 °C Ambient.

Thermal Measurement (°C)	Chamber Temperature	Q1	Bleeder R2	Damper R7	Passive Bleeder R8	Discharge Resistor R22
Peak Measurement	41	70.4	71.7	82.4	75.9	75.7
Final Stabilized Value	40.4	70.4	71.7	82.3	75.8	75.3
Thermal Measurement (°C)	LYTSwitch-3 U1	Transformer	D3	Output Capacitor C10	Output Current mA	Bulb Internal Ambient
Peak Measurement	86.1	90.7	85.6	82.5	151.47	78.6
Final Stabilized Value	85.8	90.7	85.5	81.8	150.22	78.5



12.3 Non-Dimming Thermal Performance at 265 VAC with a 30 V LED Load

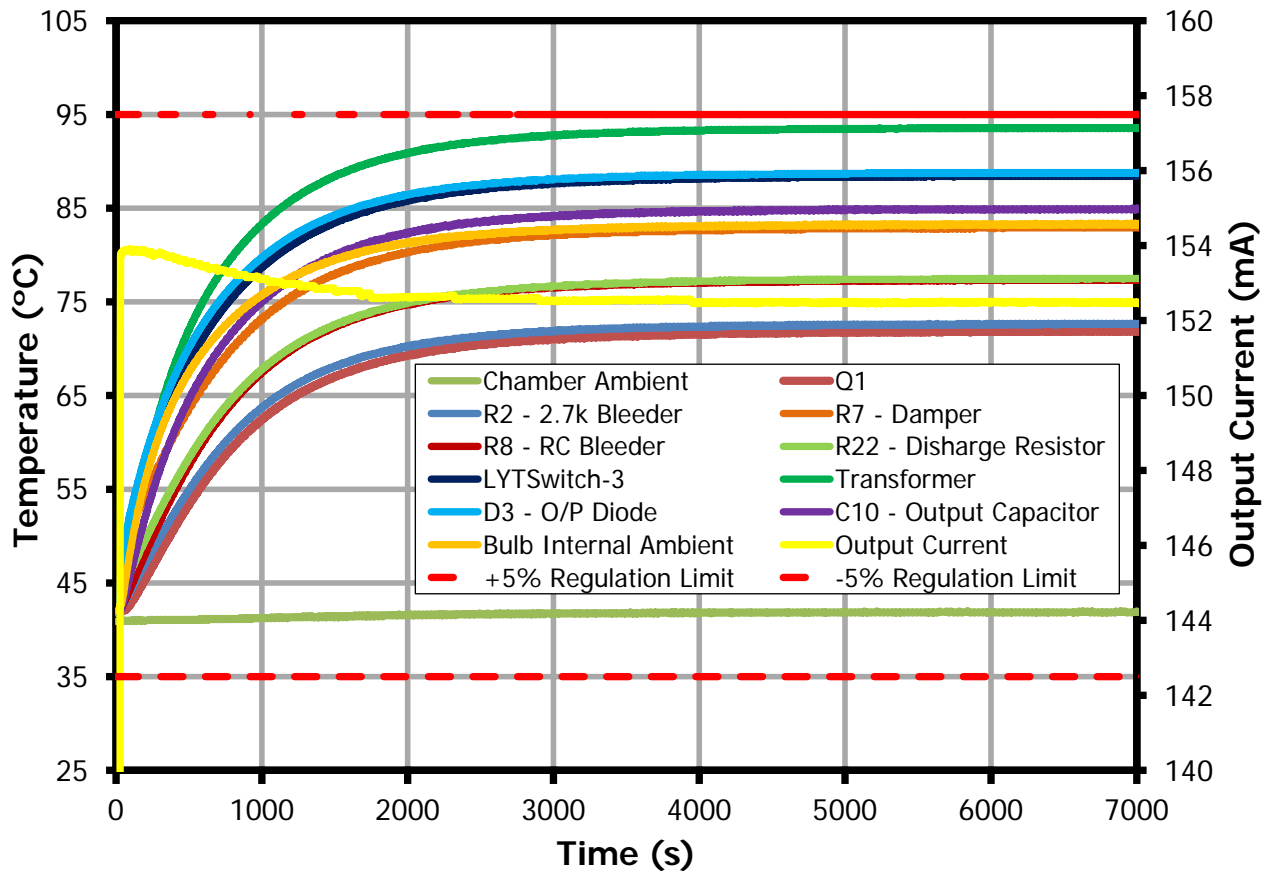

Figure 24 – Component Temperature at 265 VAC, 40 °C Ambient.

Thermal Measurement (°C)	Chamber Temperature	Q1	Bleeder R2	Damper R7	Passive Bleeder R8	Discharge Resistor R22
Peak Measurement	42	72.1	72.7	82.9	77.4	77.5
Final Stabilized Value	41.9	72.1	72.6	82.9	77.3	77.5
Thermal Measurement (°C)	LYTSwitch-3 U1	Transformer	D3	Output Capacitor C10	Output Current mA	Bulb Internal Ambient
Peak Measurement	88.5	93.6	88.8	85	153.92	83.4
Final Stabilized Value	88.5	93.6	88.8	84.9	152.51	83.2



12.4 Dimming Thermal Performance at 230 VAC, 87° Conduction Angle

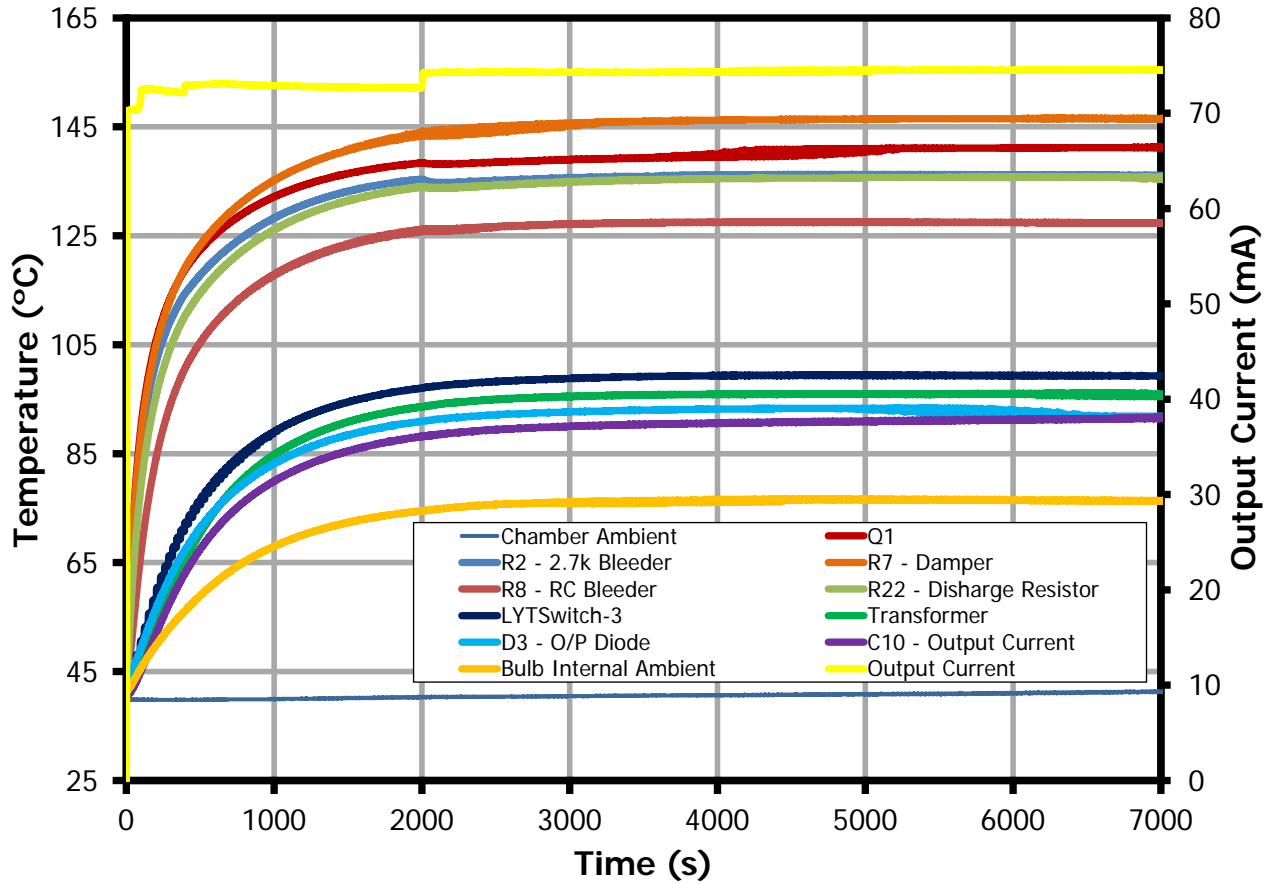

Figure 25 – Component Temperature at 230 VAC, 87° Conduction Angle, 40 °C Ambient.

Thermal Measurement (°C)	Chamber Temperature	Q1	Bleeder R2	Damper R7	Passive Bleeder R8	Discharge Resistor R22
Peak Measurement	41.5	141.3	136.3	146.6	127.6	135.8
Final Stabilized Value	41.5	141.1	135.9	146.3	126.9	134.5
Thermal Measurement (°C)	LYTSwitch-3 U1	Transformer	D3	Output Capacitor C10	Output Current mA	Bulb Internal Ambient
Peak Measurement	99.5	96.2	93.4	91.9	74.58	76.7
Final Stabilized Value	99.2	95.6	92	91.9	74.53	76.2



12.5 Dimming Thermal Performance at 230 VAC, 130° Conduction Angle

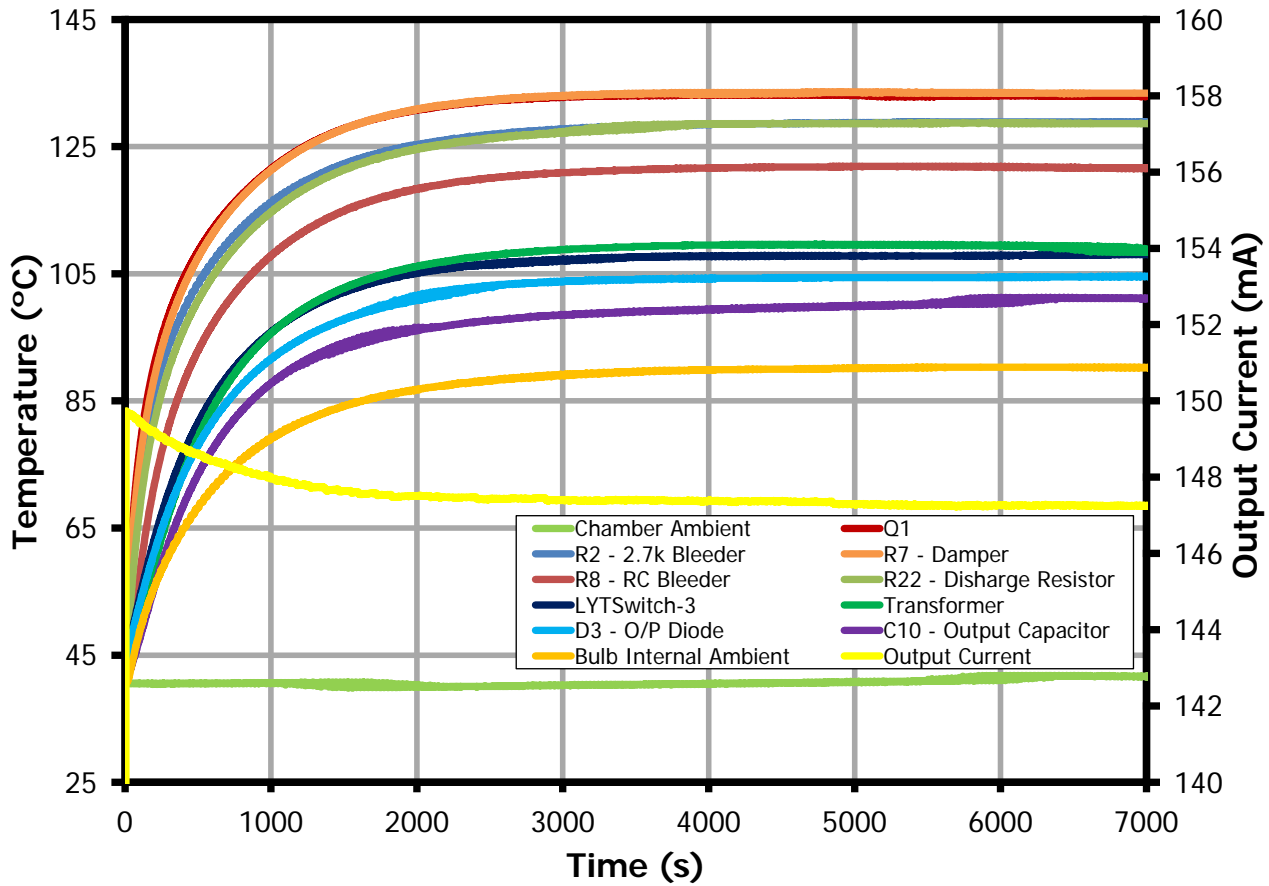

Figure 26 – Component Temperature at 230 VAC, 130° Conduction Angle, 40 °C Ambient.

Thermal Measurement (°C)	Chamber Temperature	Q1	Bleeder R2	Damper R7	Passive Bleeder R8	Discharge Resistor R22
Peak Measurement	41.8	133.2	128.9	133.6	121.9	128.7
Final Stabilized Value	41.6	132.8	128.8	133.4	121.5	128.7
Thermal Measurement (°C)	LYTSwitch-3 U1	Transformer	D3	Output Capacitor C10	Output Current mA	Bulb Internal Ambient
Peak Measurement	108.3	109.7	104.6	101.3	149.74	90.3
Final Stabilized Value	108	108.5	104.6	101.1	147.23	90.1



12.6 Dimming with Output Short-Circuit Condition at 40 °C Ambient

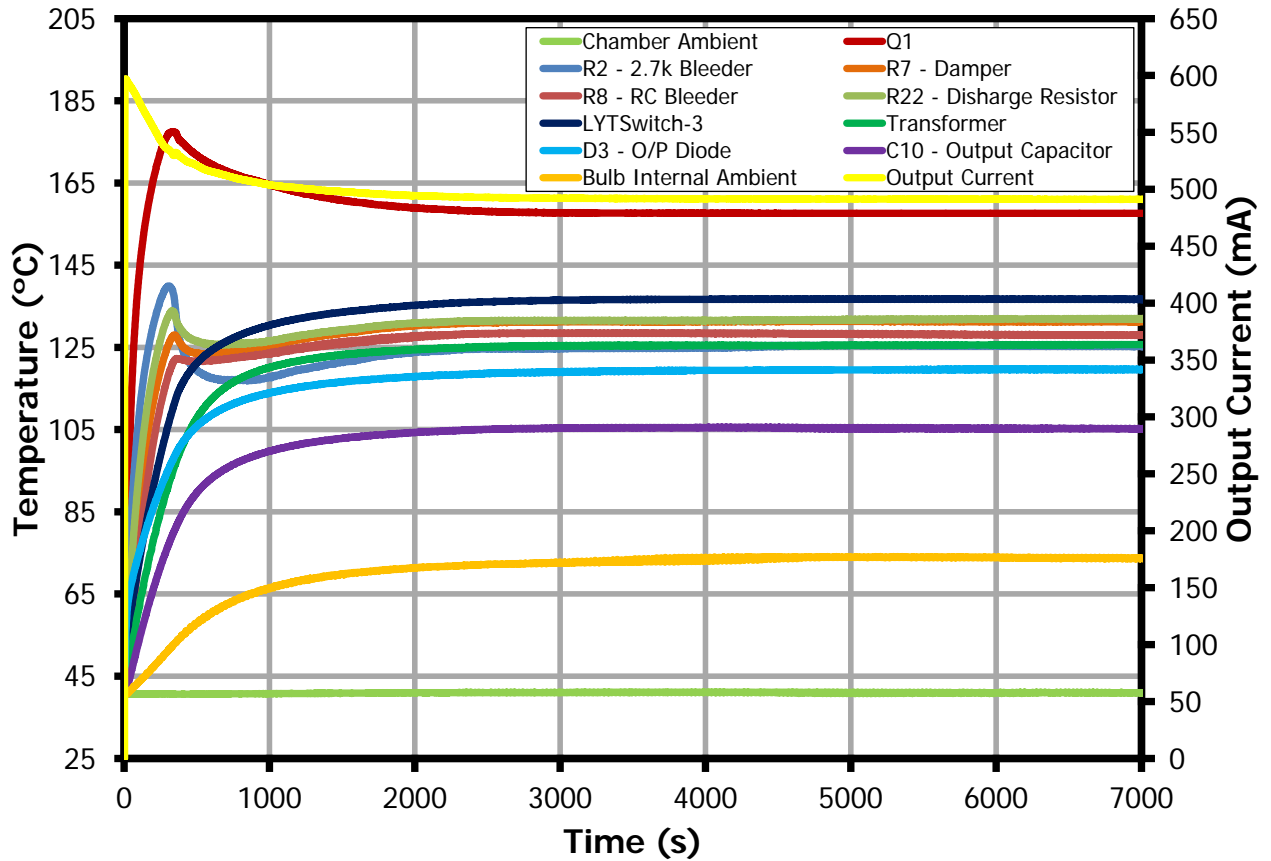

Figure 27 – Component Temperatures at 230 VAC, Tested Using a Dimmer (Jung 225 NVDE) at the Maximum Conduction Angle of 145°, 40 °C Ambient.

Thermal Measurement (°C)	Chamber Temperature	Q1	Bleeder R2	Damper R7	Passive Bleeder R8	Discharge Resistor R22
Peak Measurement	41.2	177.5	139.9	131.3	128.5	133.9
Final Stabilized Value	41.1	157.2	125	130.4	128.1	132.3
Thermal Measurement (°C)	LYTSwitch-3 U1	Transformer	D3	Output Capacitor C10	Output Current mA	Bulb Internal Ambient
Peak Measurement	136.9	125.8	119.9	105.7	597.2	74.1
Final Stabilized Value	136.7	125.6	119.7	105.6	490.8	73.3



12.7 Dimming with TRIAC Dimmer Multi-fire Condition at 40 °C Ambient

Note: Placed a large capacitor across the dimmer to force a TRIAC multi-fire.

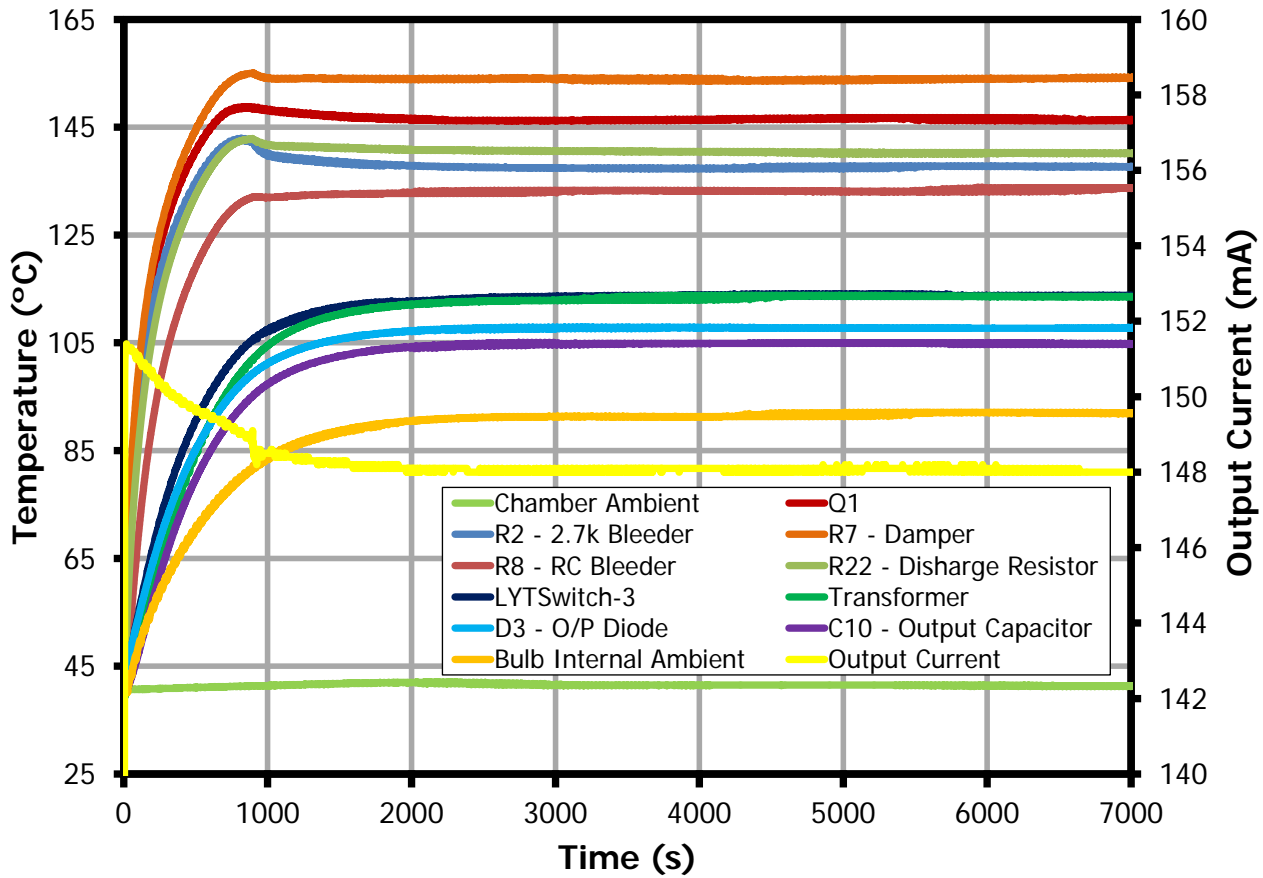

Figure 28 – Component Temperatures at 230 VAC, 145° Conduction Angle, 40 °C Ambient.

Thermal Measurement (°C)	Chamber Temperature	Q1	Bleeder R2	Damper R7	Passive Bleeder R8	Discharge Resistor R22
Peak Measurement	42.1	148.8	143	155.1	133.9	142.9
Final Stabilized Value	41.1	146.8	138.3	154	133.5	140.2
Thermal Measurement (°C)	LYTSwitch-3 U1	Transformer	D3	Output Capacitor C10	Output Current mA	Bulb Internal Ambient
Peak Measurement	114.1	113.8	108	105.1	151.4	92.9
Final Stabilized Value	113.7	113.4	108	104.7	148.1	92.4



12.8 10 Hour Burn-in at 40 °C Ambient

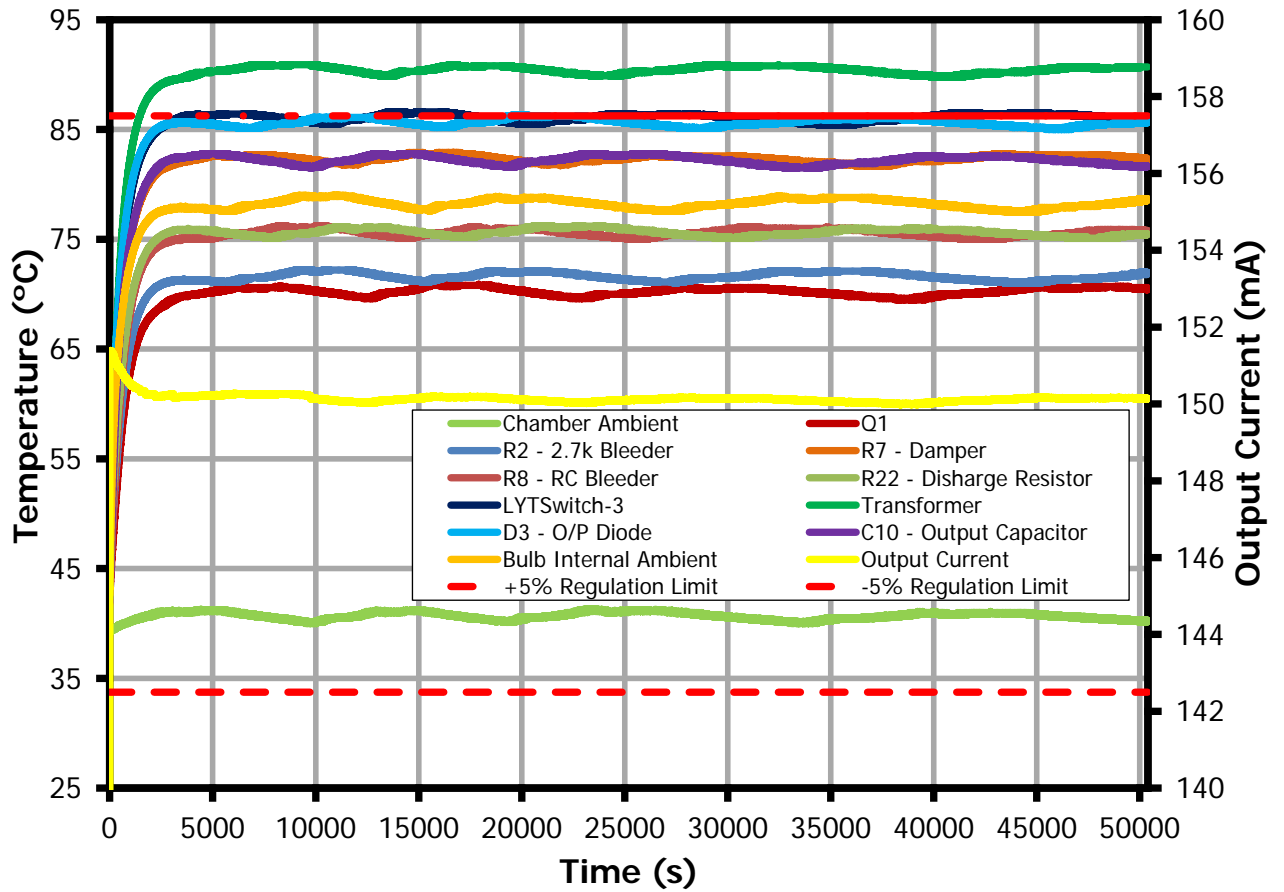

Figure 29 – Component Temperatures at 230 VAC, 40 °C Ambient, 10-hour Burn-in Test.



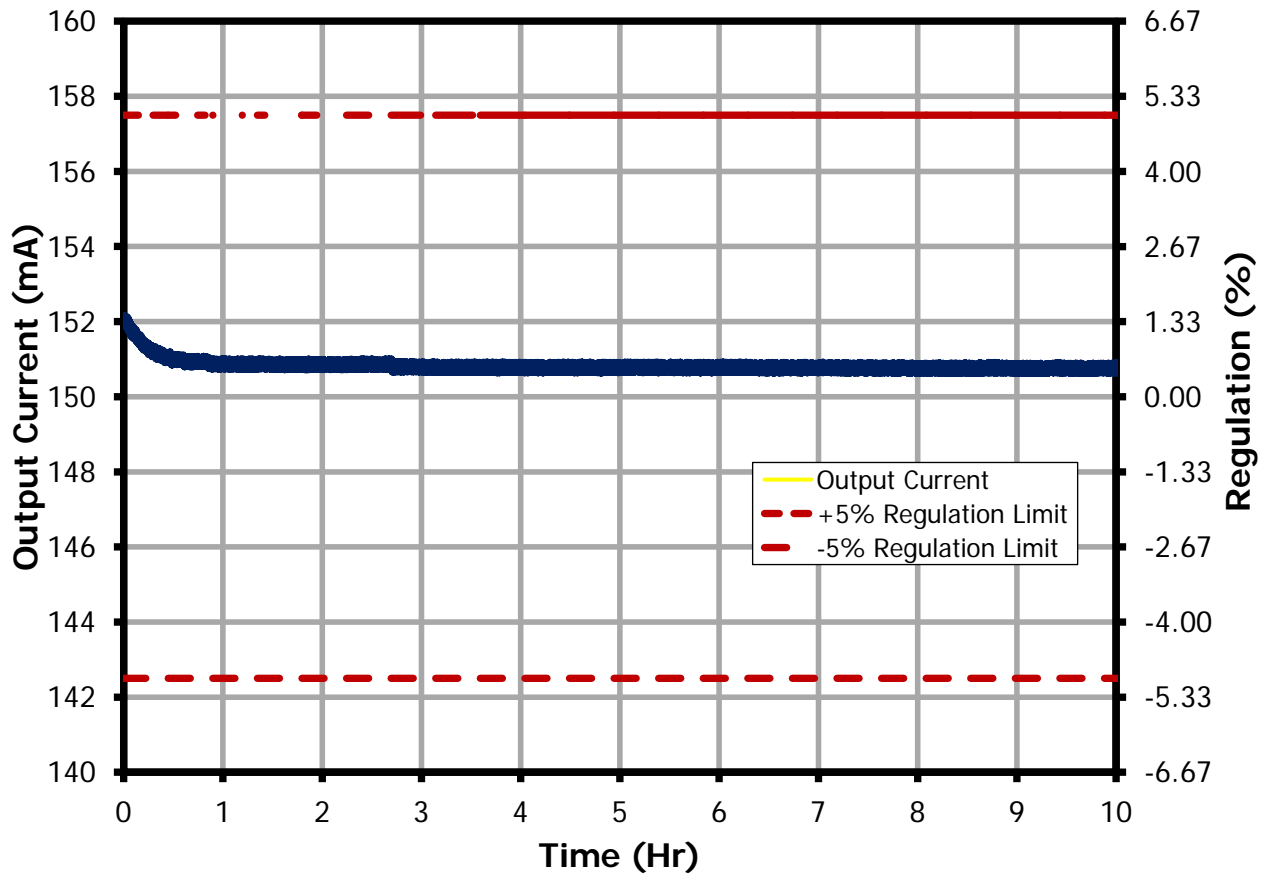

Figure 30 – Output Current Plot at 230 VAC, 40 °C Ambient, 10-hour Burn-in Test. Data Taken From the Power Meter Illustrated in the Previous Figure.



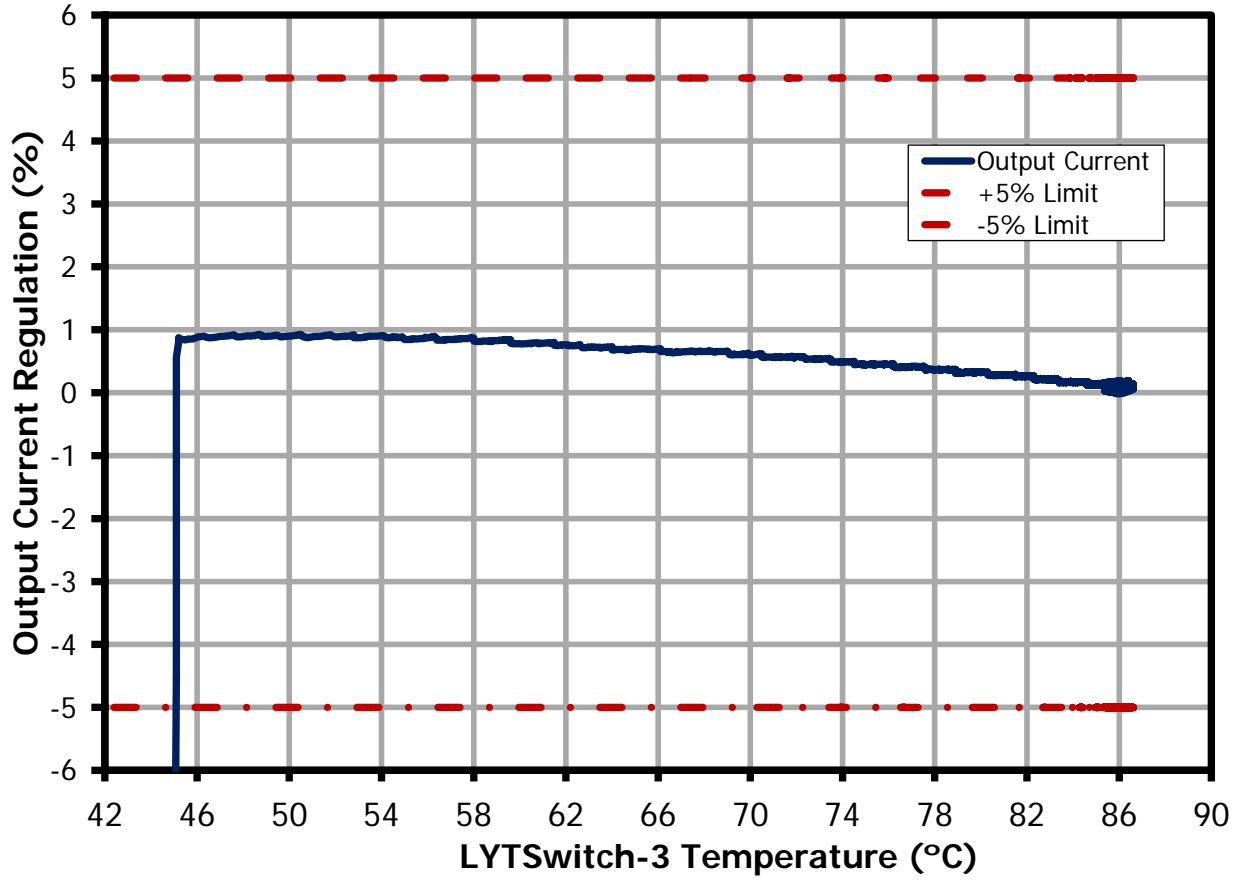

Figure 31 – Output Current Regulation with Respect to the LYTSwitch-3 Temperature at 230 VAC, 40 °C Ambient, 10-hour Burn-in Test. Data Taken From the Data Logger.



13 Waveforms

13.1 Input Voltage and Input Current Waveforms

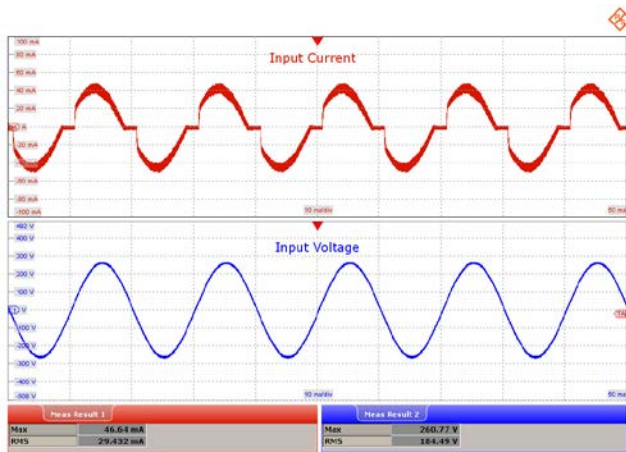

Figure 32 – 185 VAC, 30 V LED Load.
 Upper: I_{IN}, 20 mA / div.
 Lower: V_{IN}, 100 V / div., 10 ms / div.
 Peak I_{IN}: 46.64 mA.
 Peak V_{IN}: 260.77 V.

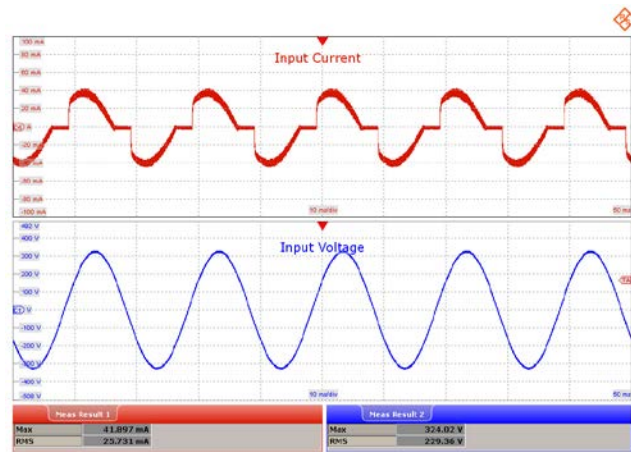

Figure 33 – 230 VAC, 30 V LED Load.
 Upper: I_{IN}, 20 mA / div.
 Lower: V_{IN}, 100 V / div., 10 ms / div.
 Peak I_{IN}: 41.897 mA.
 Peak V_{IN}: 324.02 V.

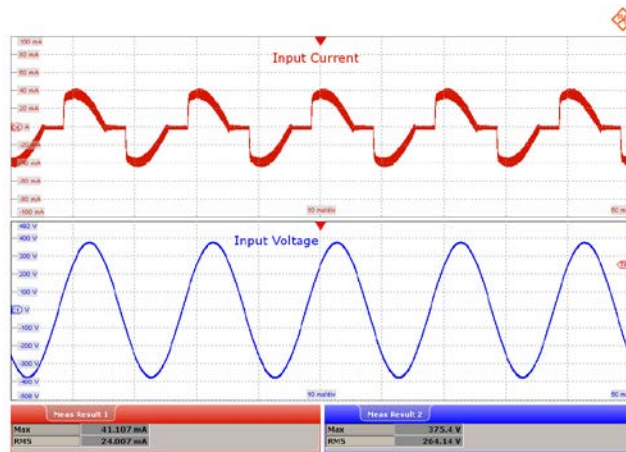

Figure 34 – 265 VAC, 30 V LED Load.
 Upper: I_{IN}, 20 mA / div.
 Lower: V_{IN}, 100 V / div., 10 ms / div.
 Peak I_{IN}: 41.107 mA.
 Peak V_{IN}: 375.4 V.

13.2 Output Current Rise and Fall

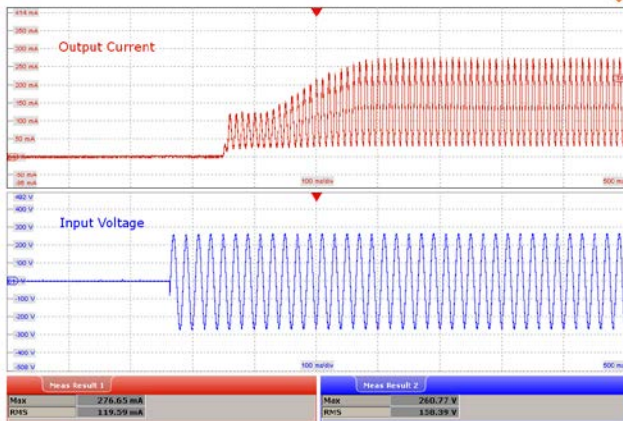

Figure 35 – 185 VAC, 30 V LED Load, Output Rise.
 Upper: I_{OUT} , 50 mA / div.
 Lower: V_{IN} , 100 V / div., 100 ms / div.
 Peak I_{OUT} : 276.65 mA.
 Peak V_{IN} : 260.77 V.

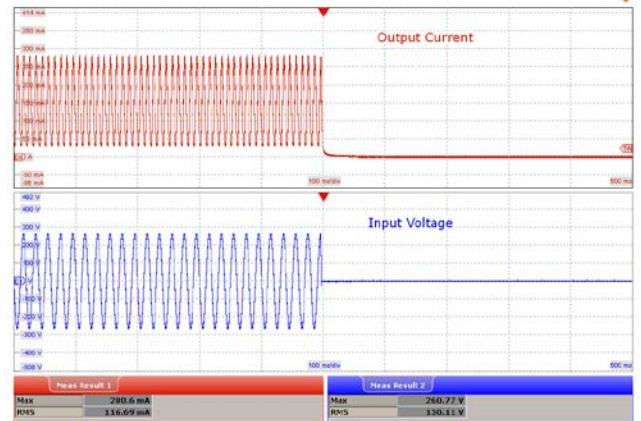

Figure 36 – 185 VAC, 30 V LED Load, Output Fall.
 Upper: I_{OUT} , 50 mA / div.
 Lower: V_{IN} , 100 V / div., 100 ms / div.
 Peak I_{OUT} : 280.6 mA.
 Peak V_{IN} : 260.77 V.

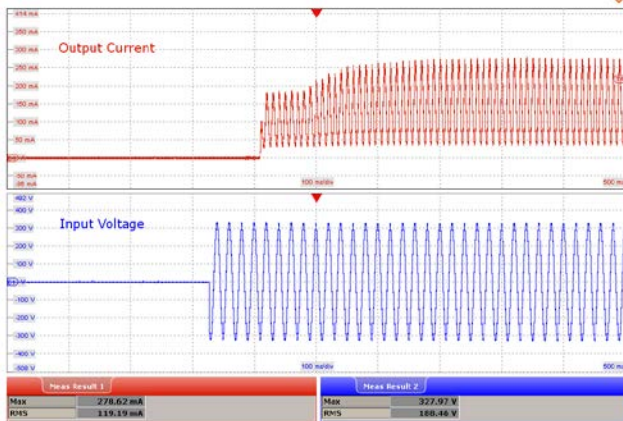

Figure 37 – 230 VAC, 30 V LED Load, Output Rise.
 Upper: I_{OUT} , 50 mA / div.
 Lower: V_{IN} , 100 V / div., 100 ms / div.
 Peak I_{OUT} : 278.62 mA.
 Peak V_{IN} : 327.97 V.

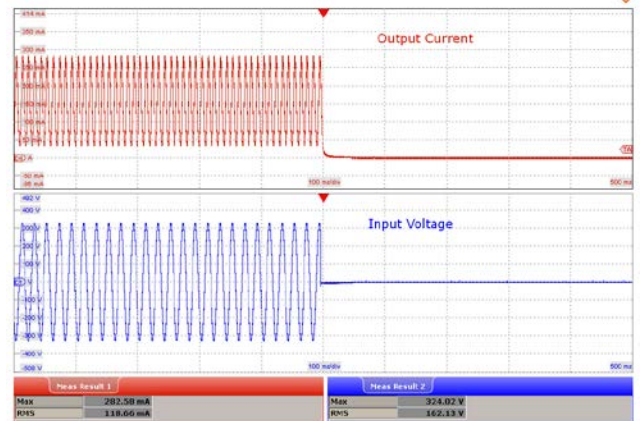

Figure 38 – 230 VAC, 30 V LED Load, Output Fall.
 Upper: I_{OUT} , 50 mA / div.
 Lower: V_{IN} , 100 V / div., 100 ms / div.
 Peak I_{OUT} : 282.58 mA.
 Peak V_{IN} : 324.02 V.



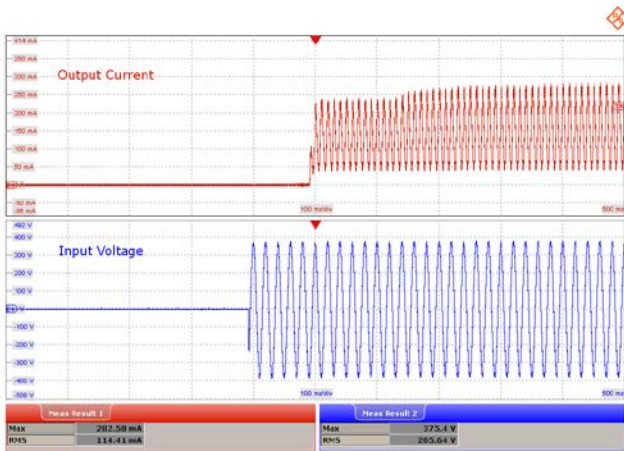

Figure 39 – 265 VAC, 30 V LED Load, Output Rise.
 Upper: I_{OUT} , 50 mA / div.
 Lower: V_{IN} , 100 V / div., 100 ms / div.
 Peak I_{OUT} : 282.58 mA.
 Peak V_{IN} : 375.4 V.

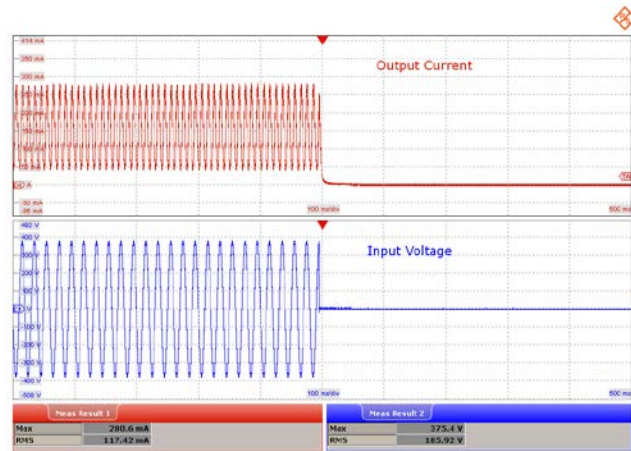

Figure 40 – 265 VAC, 30 V LED Load, Output Fall.
 Upper: I_{OUT} , 50 mA / div.
 Lower: V_{IN} , 100 V / div., 100 ms / div.
 Peak I_{OUT} : 280.6 mA.
 Peak V_{IN} : 375.4 V.

13.3 Drain Voltage and Current in Normal Operation

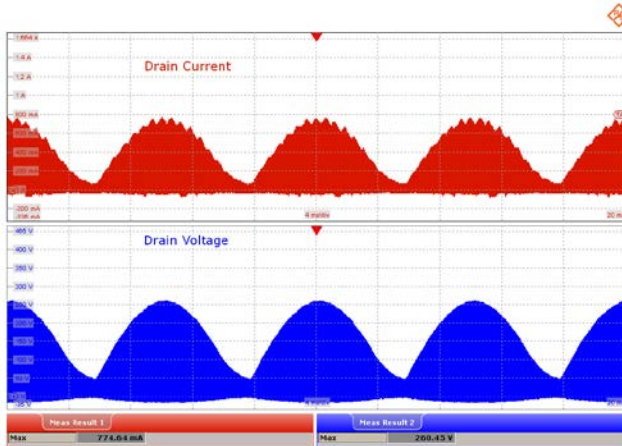

Figure 41 – 185 VAC, 30 V LED Load.
 Upper: I_{DRAIN} , 200 mA / div.
 Lower: V_{DRAIN} , 50 V / div., 4 ms / div.
 Peak I_{DRAIN} : 774.64 mA.
 Peak V_{DRAIN} : 260.45 V.



Figure 42 – 185 VAC, 30 V LED Load.
 Upper: I_{DRAIN} , 200 mA / div.
 Lower: V_{DRAIN} , 50 V / div., 5 μ s / div.
 Peak I_{DRAIN} : 774.64 mA.
 Peak V_{DRAIN} : 260.45 V.

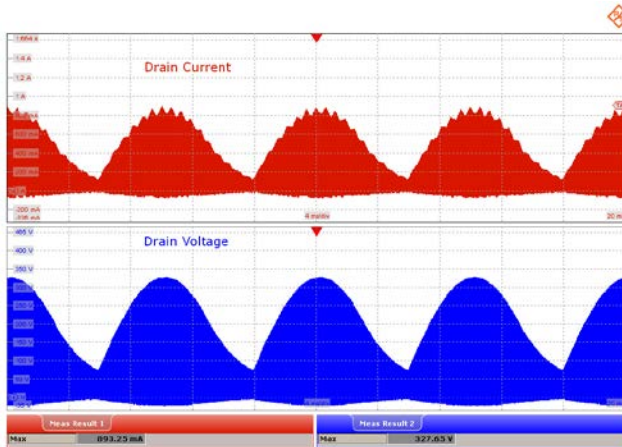

Figure 43 – 230 VAC, 30 V LED Load.
 Upper: I_{DRAIN} , 200 mA / div.
 Lower: V_{DRAIN} , 50 V / div., 4 ms / div.
 Peak I_{DRAIN} : 893.25 mA.
 Peak V_{DRAIN} : 327.65 V.



Figure 44 – 230 VAC, 30 V LED Load.
 Upper: I_{DRAIN} , 200 mA / div.
 Lower: V_{DRAIN} , 50 V / div., 5 μ s / div.
 Peak I_{DRAIN} : 893.25 mA.
 Peak V_{DRAIN} : 327.65 V.



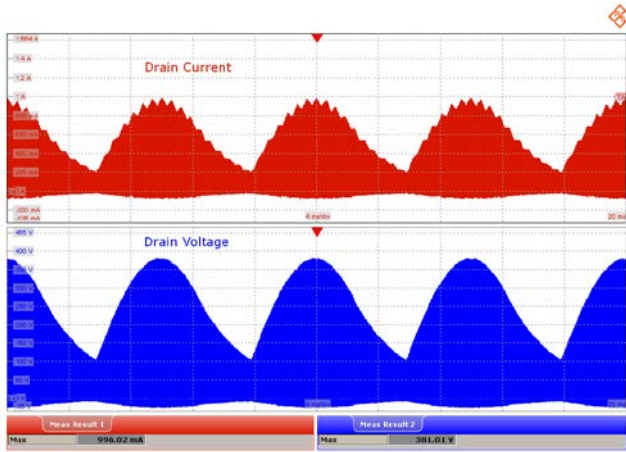

Figure 45 – 265 VAC, 30 V LED Load.
 Upper: I_{DRAIN} , 200 mA / div.
 Lower: V_{DRAIN} , 50 V / div., 4 ms / div.
 Peak I_{DRAIN} : 996.02 mA.
 Peak V_{DRAIN} : 381.01 V.

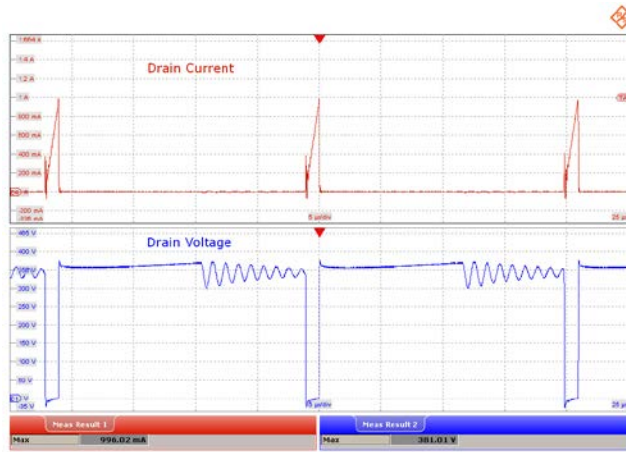

Figure 46 – 265 VAC, 30 V LED Load.
 Upper: I_{DRAIN} , 200 mA / div.
 Lower: V_{DRAIN} , 50 V / div., 5 μ s / div.
 Peak I_{DRAIN} : 996.02 mA.
 Peak V_{DRAIN} : 381.01 V.

13.4 Drain Voltage and Current Start-up Profile



Figure 47 – 185 VAC, 30 V LED Load, Start-up.
 Upper: I_{DRAIN} , 400 mA / div.
 Lower: V_{DRAIN} , 50 V / div., 20 ms / div.
 Peak I_{DRAIN} : 1.913 A.
 Peak V_{DRAIN} : 268.36 V.



Figure 48 – 185 VAC, 30 V LED Load, Start-up.
 Upper: I_{DRAIN} , 400 mA / div.
 Lower: V_{DRAIN} , 50 V / div., 10 μ s / div.
 Peak I_{DRAIN} : 1.913 A.
 Peak V_{DRAIN} : 268.36 V.

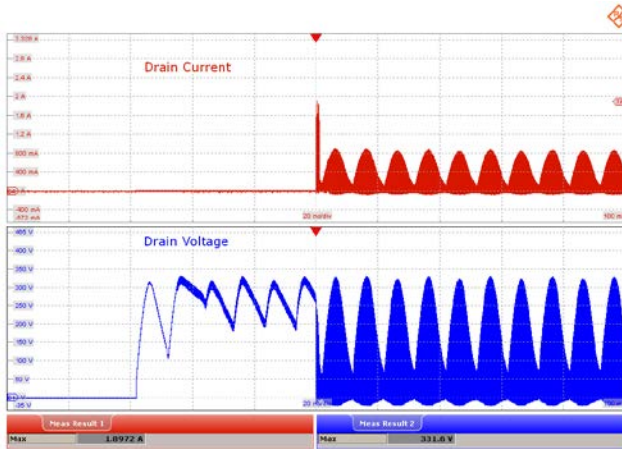

Figure 49 – 230 VAC, 30 V LED Load, Start-up.
 Upper: I_{DRAIN} , 400 mA / div.
 Lower: V_{DRAIN} , 50 V / div., 20 ms / div.
 Peak I_{DRAIN} : 1.8972 A.
 Peak V_{DRAIN} : 331.6 V.

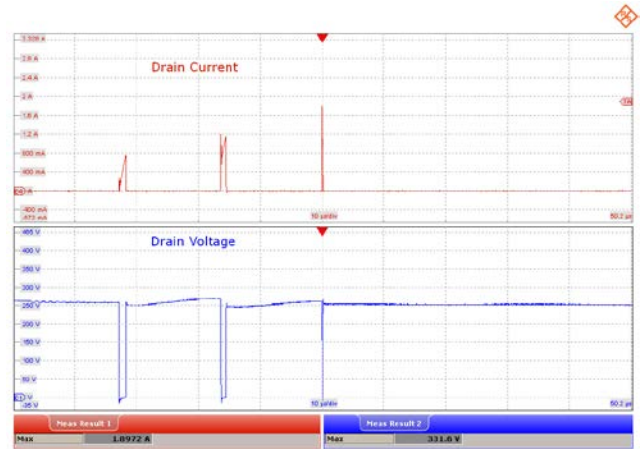

Figure 50 – 230 VAC, 30 V LED Load, Start-up.
 Upper: I_{DRAIN} , 400 mA / div.
 Lower: V_{DRAIN} , 50 V / div., 10 μ s / div.
 Peak I_{DRAIN} : 1.8972 A.
 Peak V_{DRAIN} : 331.6 V.



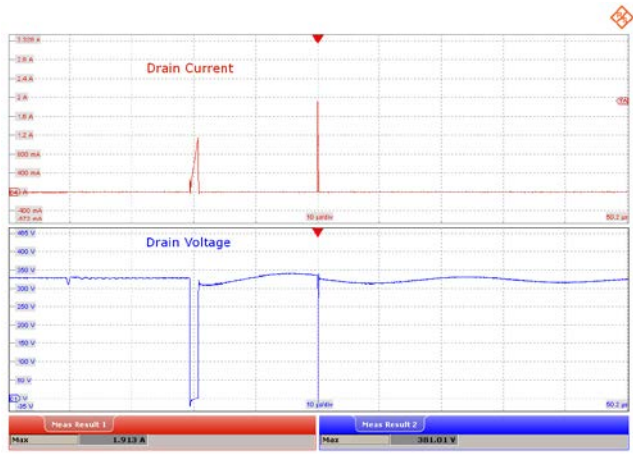
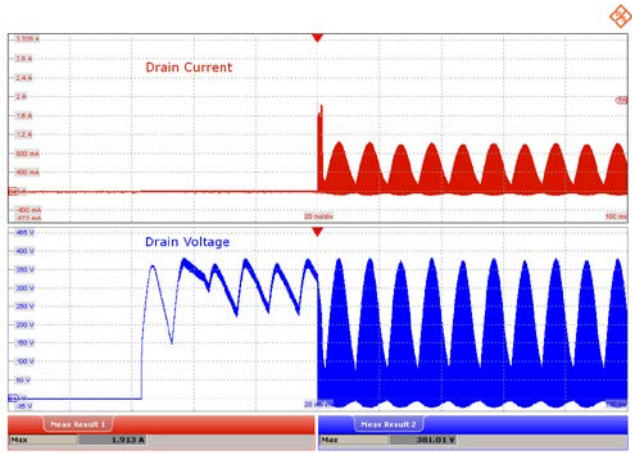

Figure 51 – 265 VAC, 30 V LED Load, Start-up.
 Upper: I_{DRAIN} , 400 mA / div.
 Lower: V_{DRAIN} , 50 V / div., 20 ms / div.
 Peak I_{DRAIN} : 1.913 A.
 Peak V_{DRAIN} : 381.01 V.

Figure 52 – 265 VAC, 30 V LED Load, Start-up.
 Upper: I_{DRAIN} , 400 mA / div.
 Lower: V_{DRAIN} , 50 V / div., 10 μ s / div.
 Peak I_{DRAIN} : 1.913 A.
 Peak V_{DRAIN} : 381.01 V.

13.5 Drain Voltage and Current during Output Short-Circuit Condition

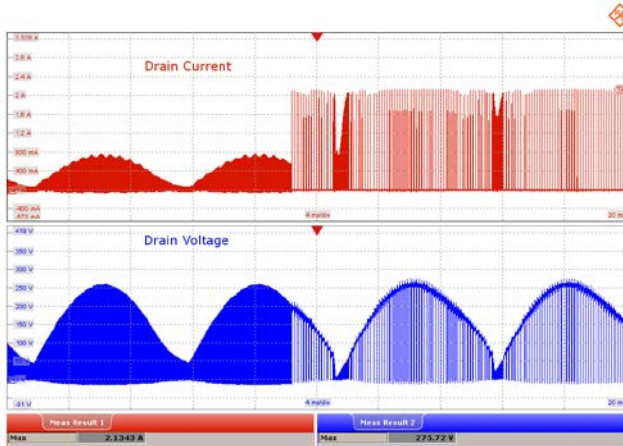

Figure 53 – 185 VAC, Output Short.
 Upper: I_{DRAIN} , 400 mA / div.
 Lower: V_{DRAIN} , 50 V / div., 4 ms / div.
 Peak I_{DRAIN} : 2.1343 A.
 Peak V_{DRAIN} : 275.72 V.

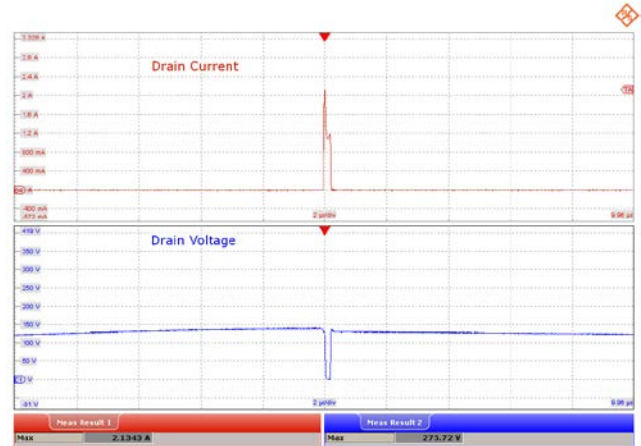

Figure 54 – 185 VAC, Output Short.
 Upper: I_{DRAIN} , 400 mA / div.
 Lower: V_{DRAIN} , 50 V / div., 2 µs / div.
 Peak I_{DRAIN} : 2.1343 A.
 Peak V_{DRAIN} : 275.72 V.

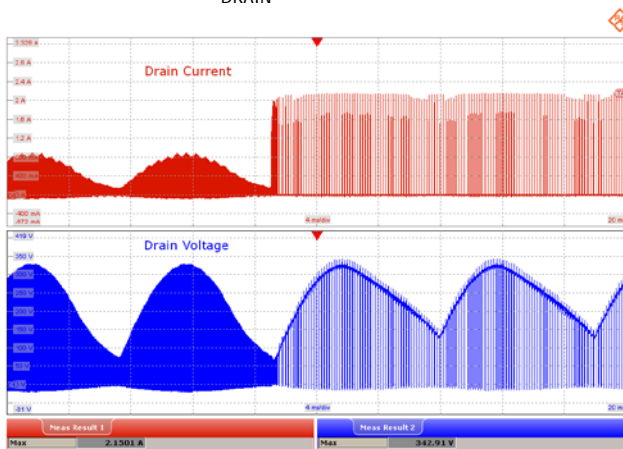

Figure 55 – 265 VAC, Output Short.
 Upper: I_{DRAIN} , 400 mA / div.
 Lower: V_{DRAIN} , 50 V / div., 4 ms / div.
 Peak I_{DRAIN} : 2.1501 A.
 Peak V_{DRAIN} : 342.91 V.



Figure 56 – 265 VAC, Output Short.
 Upper: I_{DRAIN} , 400 mA / div.
 Lower: V_{DRAIN} , 50 V / div., 2 µs / div.
 Peak I_{DRAIN} : 2.1501 A.
 Peak V_{DRAIN} : 342.91 V.



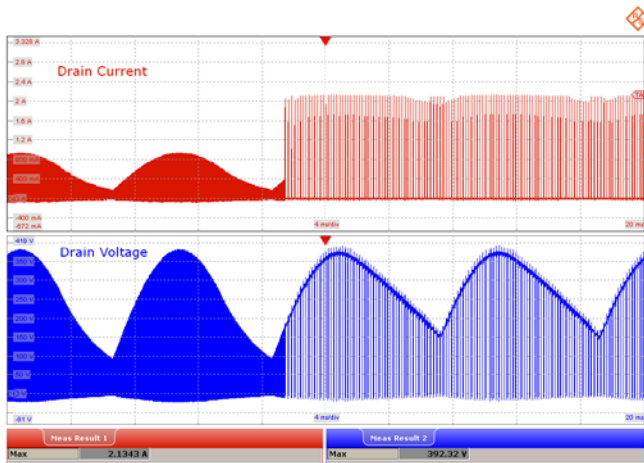

Figure 57 – 265 VAC, Output Short.
 Upper: I_{DRAIN} , 400 mA / div.
 Lower: V_{DRAIN} , 50 V / div., 4 ms / div.
 Peak I_{DRAIN} : 2.1343 A.
 Peak V_{DRAIN} : 392.32 V.



Figure 58 – 265 VAC, Output Short.
 Upper: I_{DRAIN} , 400 mA / div.
 Lower: V_{DRAIN} , 50 V / div., 2 μ s / div.
 Peak I_{DRAIN} : 2.1343 A.
 Peak V_{DRAIN} : 392.32 V.

Input		Input Measurement During Output Short			Output Measurement During Output Short		
VAC (V_{RMS})	Freq (Hz)	V_{IN} (V_{RMS})	I_{IN} (mA_{RMS})	P_{IN} (W)	V_{OUT} (V_{RMS})	I_{OUT} (mA_{RMS})	P_{OUT} (W)
185	50	184.94	22.53	2.12	---	728.00	---
200	50	199.94	22.15	2.19	---	747.30	---
220	50	219.99	20.01	2.25	---	757.80	---
230	50	230.02	17.04	2.18	---	742.30	---
240	50	239.97	15.96	2.19	---	735.40	---
265	50	265.00	14.49	2.26	---	737.50	---

13.6 Output Diode Voltage and Current in Normal Operation

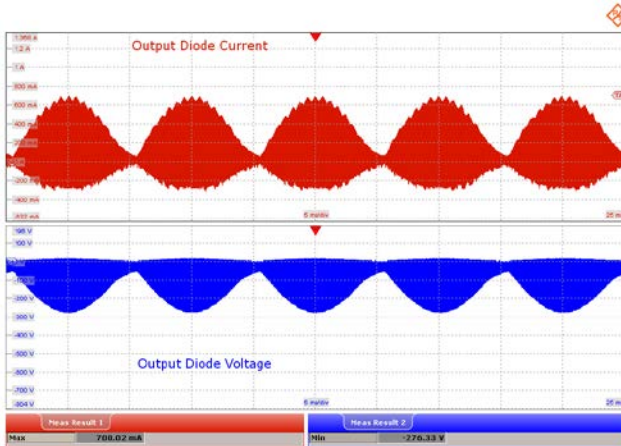

Figure 59 – 185 VAC, 30 V LED Load.
 Upper: I_{DIODE} , 200 mA / div.
 Lower: V_{DIODE} , 100 V / div., 5 ms / div.
 Peak I_{DIODE} : 700.02 mA.
 Peak V_{DIODE} : 276.33 V.

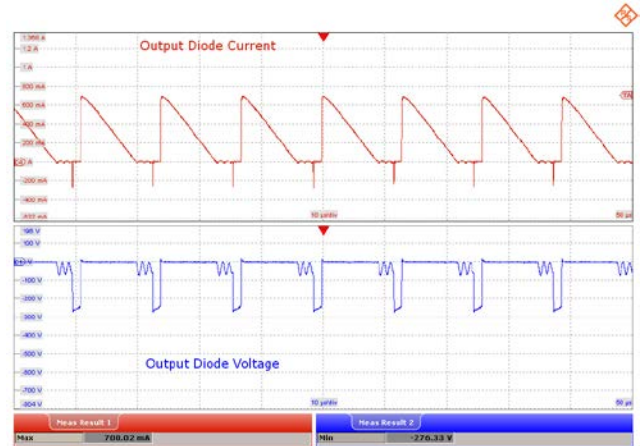

Figure 60 – 185 VAC, 30 V LED Load.
 Upper: I_{DIODE} , 200 mA / div.
 Lower: V_{DIODE} , 100 V / div., 10 μs / div.
 Peak I_{DIODE} : 700.02 mA.
 Peak V_{DIODE} : 276.33 V.

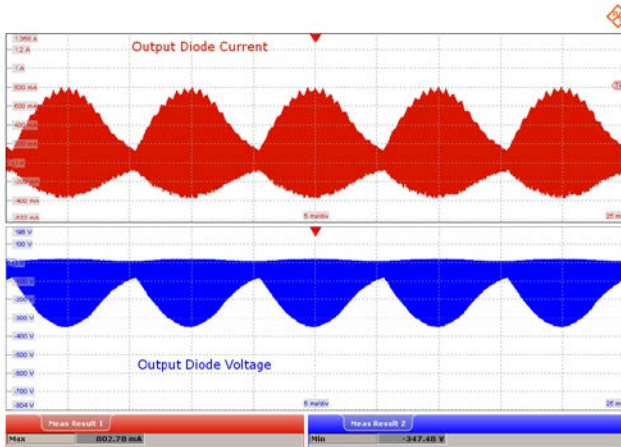

Figure 61 – 230 VAC, 30 V LED Load.
 Upper: I_{DIODE} , 200 mA / div.
 Lower: V_{DIODE} , 100 V / div., 5 ms / div.
 Peak I_{DIODE} : 802.78 mA.
 Peak V_{DIODE} : 347.48 V.

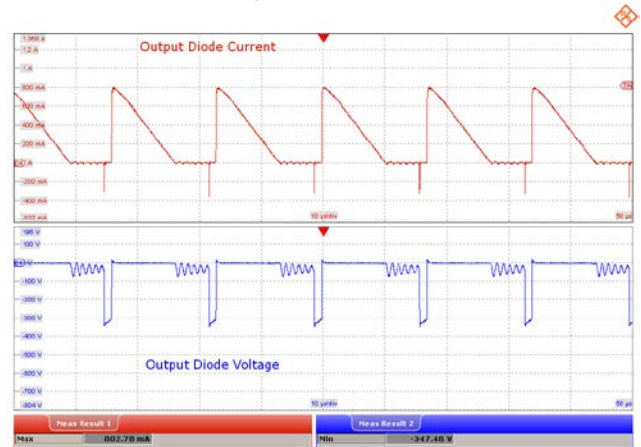

Figure 62 – 230 VAC, 30 V LED Load.
 Upper: I_{DIODE} , 200 mA / div.
 Lower: V_{DIODE} , 100 V / div., 10 μs / div.
 Peak I_{DIODE} : 802.78 mA.
 Peak V_{DIODE} : 347.48 V.



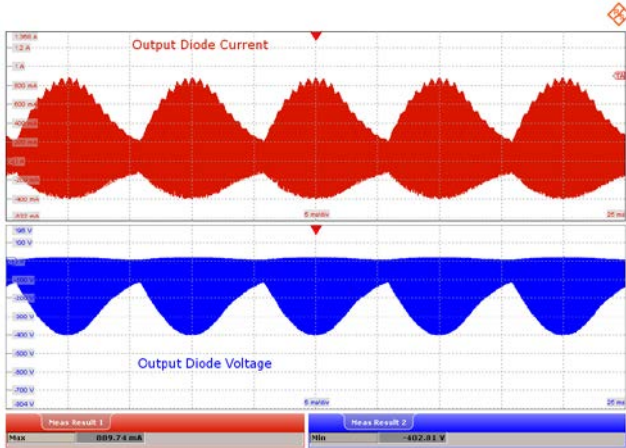

Figure 63 – 265 VAC, 30 V LED Load.
 Upper: I_{DIODE} , 200 mA / div.
 Lower: V_{DIODE} , 100 V / div., 5 ms / div.
 Peak I_{DIODE} : 889.74 mA.
 Peak V_{DIODE} : 402.81 V.

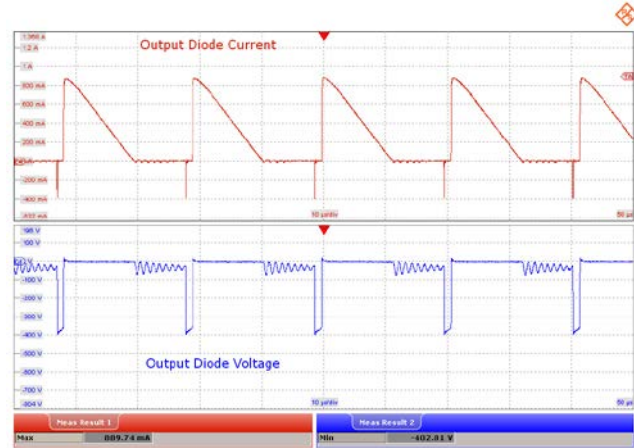

Figure 64 – 265 VAC, 30 V LED Load.
 Upper: I_{DIODE} , 200 mA / div.
 Lower: V_{DIODE} , 100 V / div., 10 µs / div.
 Peak I_{DIODE} : 889.74 mA.
 Peak V_{DIODE} : 402.81 V.

13.7 Output Voltage and Current – Open LED Load

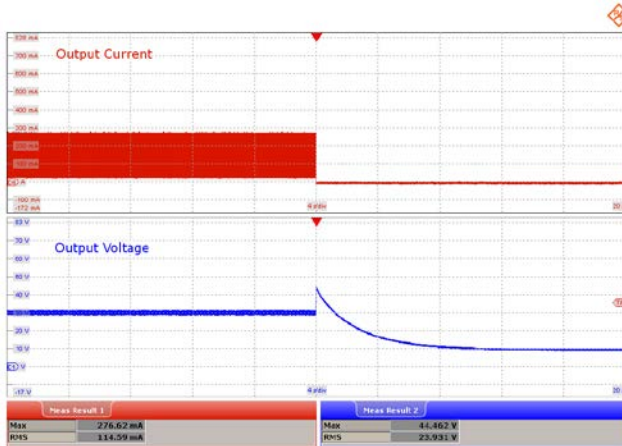

Figure 65 – 185 VAC, 30 V LED Load, Running Open Load.
 Upper: I_{OUT} , 100 mA / div.
 Lower: V_{OUT} , 10 V / div., 4 s / div.
 Peak I_{OUT} : 276.62 mA.
 Peak V_{OUT} : 44.462 V.

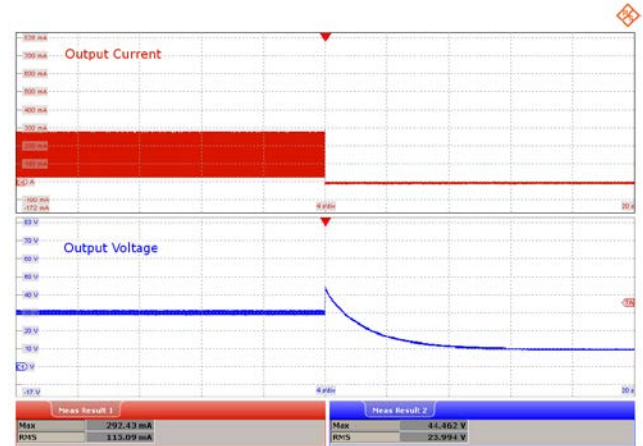

Figure 66 – 230 VAC, 30 V LED Load, Running Open Load.
 Upper: I_{OUT} , 100 mA / div.
 Lower: V_{OUT} , 10 V / div., 4 s / div.
 Peak I_{OUT} : 292.43 mA.
 Peak V_{OUT} : 44.462 V.

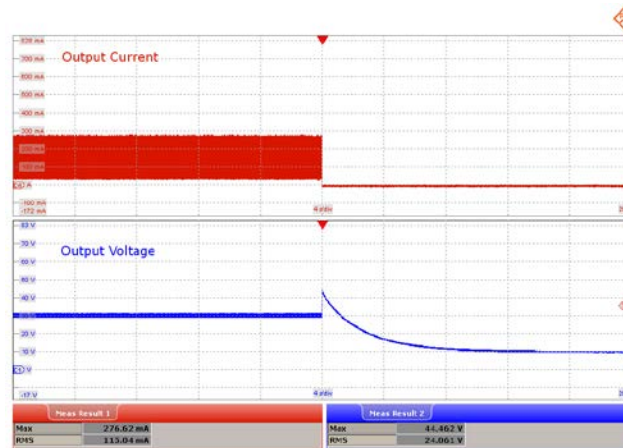

Figure 67 – 265 VAC, 30 V LED Load, Running Open Load.
 Upper: I_{OUT} , 100 mA / div.
 Lower: V_{OUT} , 10 V / div., 4 s / div.
 Peak I_{OUT} : 276.62 mA.
 Peak V_{OUT} : 44.462 V.



13.8 Output Ripple Current

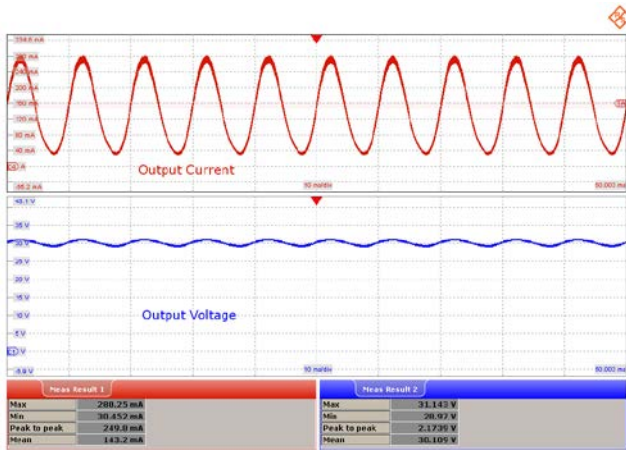

Figure 68 – 185 VAC, 50 Hz, 30 V LED Load.
Upper: I_{OUT} , 50 mA / div., 5 ms / div.

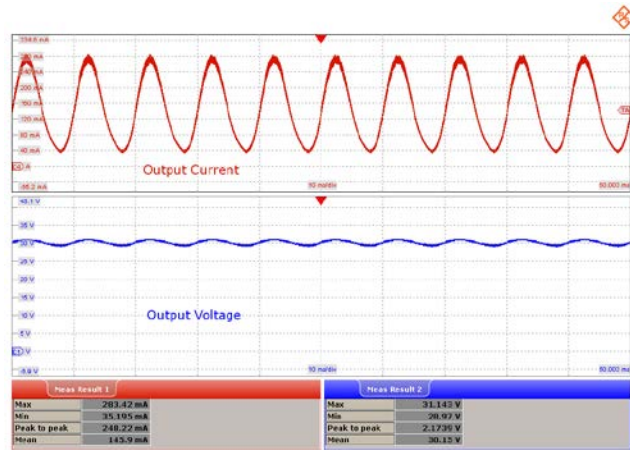

Figure 69 – 230 VAC, 50 Hz, 30 V LED Load.
Upper: I_{OUT} , 50 mA / div., 5 ms / div.

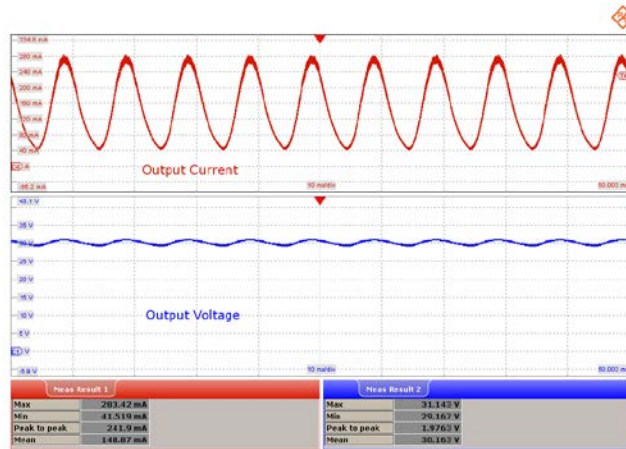

Figure 70 – 265 VAC, 50 Hz, 30 V LED Load.
Upper: I_{OUT} , 50 mA / div., 5 ms / div.

V_{IN} (VAC)	$I_{O(MAX)}$ (mA)	$I_{O(MIN)}$ (mA)	I_{MEAN}	Ripple Ratio (I_{RP-P}/I_{MEAN})	% Flicker $100 \times (I_{RP-P} / I_{O(MAX)} + I_{O(MIN)})$
185	280.25	30.45	143.2	1.74	80.4
230	283.42	35.20	145.9	1.70	77.9
265	283.42	41.52	148.9	1.62	74.5

14 Dimming Waveforms

14.1 *Input Voltage and Input Current Waveforms – Leading Edge Dimmer*

Input: 230 VAC, 50 Hz

Output: 30 V LED load

Dimmer: Berker 2875

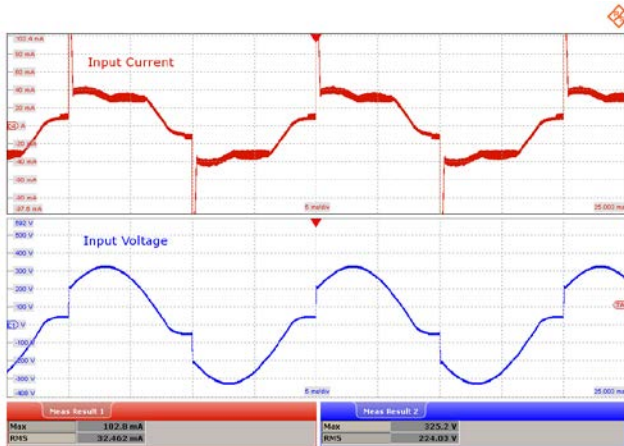

Figure 71 – 145° Conduction Angle.
Upper: I_{IN} , 20 mA / div.
Lower: V_{IN} , 100 V / div., 5 ms / div.
Peak V_{IN} : 325.2 V.
 V_{RMS} : 224.03 V

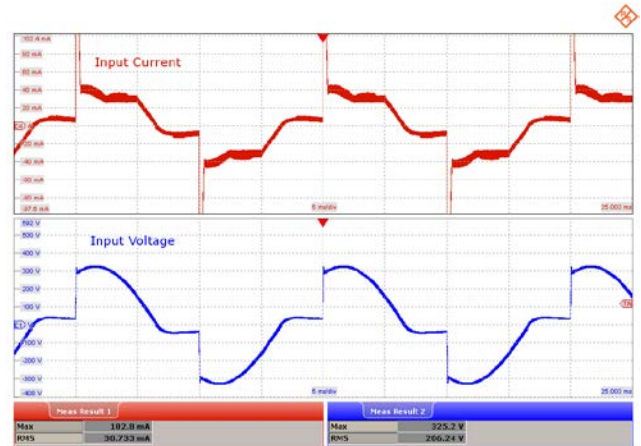

Figure 72 – 120° Conduction Angle.
Upper: I_{IN} , 20 mA / div.
Lower: V_{IN} , 100 V / div., 5 ms / div.
Peak V_{IN} : 325.2 V.
 V_{RMS} : 206.24 V

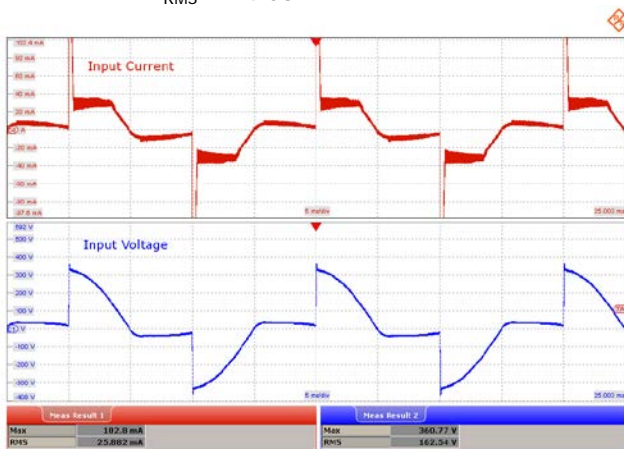

Figure 73 – 90° Conduction Angle.
Upper: I_{IN} , 20 mA / div.
Lower: V_{IN} , 100 V / div., 5 ms / div.
Peak V_{IN} : 360.77 V.
 V_{RMS} : 162.54 V



Figure 74 – 45° Conduction Angle.
Upper: I_{IN} , 20 mA / div.
Lower: V_{IN} , 100 V / div., 5 ms / div.
Peak V_{IN} : 246.15 V.
 V_{RMS} : 69.662 V

14.2 Output Current Waveforms – Leading Edge Dimmer

Input: 230 VAC, 50 Hz
 Output: 30 V LED load
 Dimmer: Berker 2875

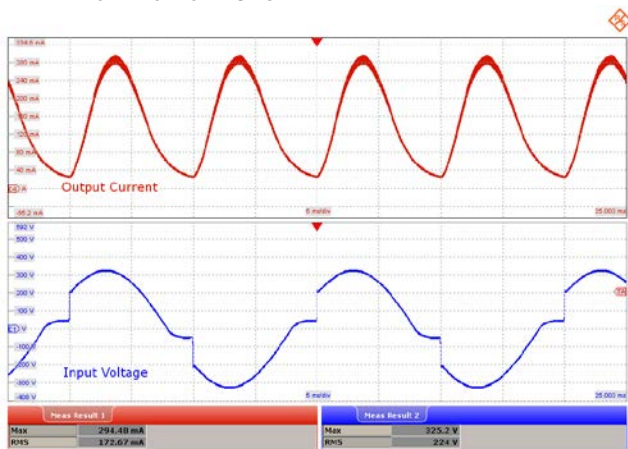

Figure 75 – 145° Conduction Angle.
 Upper: I_{OUT} , 40 mA / div.
 Lower: V_{IN} , 100 V / div., 5 ms / div.
 Peak I_{OUT} : 294.48 mA
 Peak V_{IN} : 325.2 V.

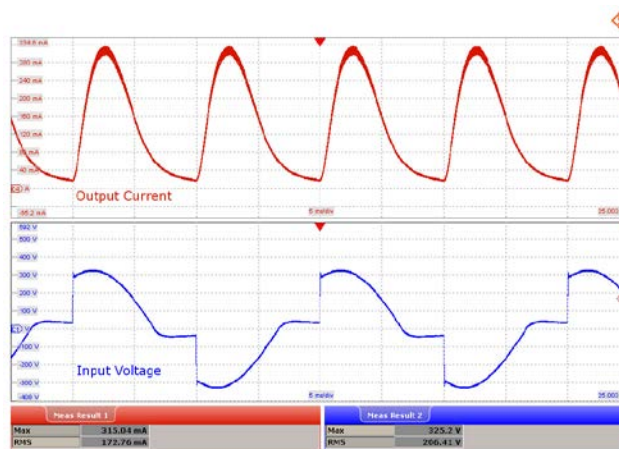

Figure 76 – 120° Conduction Angle.
 Upper: I_{OUT} , 40 mA / div.
 Lower: V_{IN} , 100 V / div., 5 ms / div.
 Peak I_{OUT} : 315.04 mA
 Peak V_{IN} : 325.2 V.

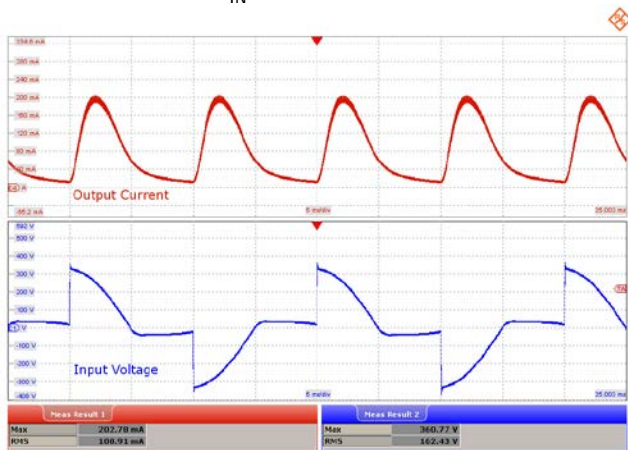

Figure 77 – 90° Conduction Angle.
 Upper: I_{OUT} , 40 mA / div.
 Lower: V_{IN} , 100 V / div., 5 ms / div.
 Peak I_{OUT} : 202.78 mA
 Peak V_{IN} : 360.77 V.

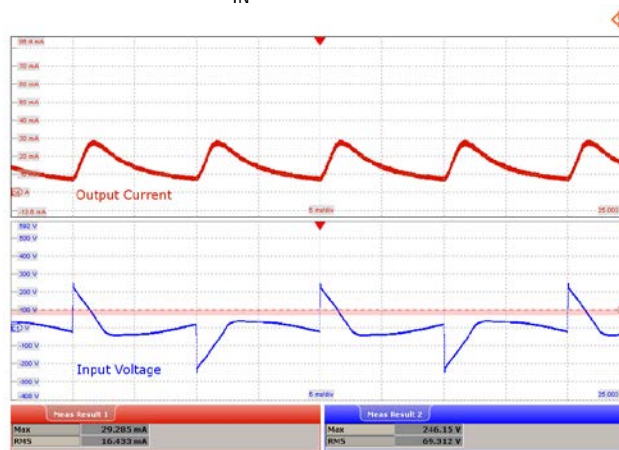

Figure 78 – 45° Conduction Angle.
 Upper: I_{OUT} , 10 mA / div.
 Lower: V_{IN} , 100 V / div., 5 ms / div.
 Peak I_{OUT} : 29.285 mA
 Peak V_{IN} : 246.15 V.

14.3 Input Voltage and Input Current Waveforms – Trailing Edge Dimmer

Input: 230 VAC, 50 Hz

Output: 30 V LED load

Dimmer: GIRA 0307 00-I02

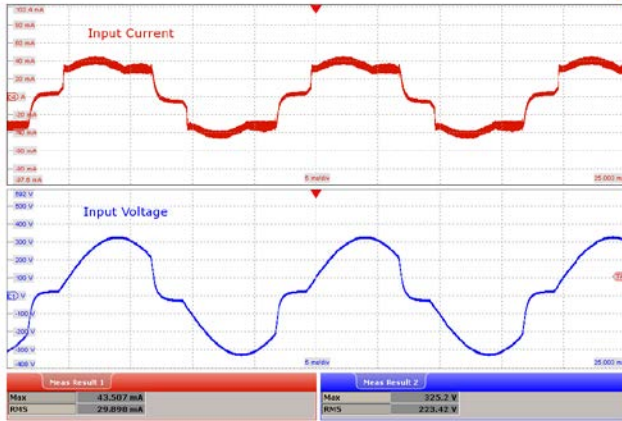

Figure 79 – 145° Conduction Angle.
 Upper: I_{IN} , 20 mA / div.
 Lower: V_{IN} , 100 V / div., 5 ms / div.
 Peak V_{IN} : 325.2 V.
 V_{RMS} : 223.42 V.

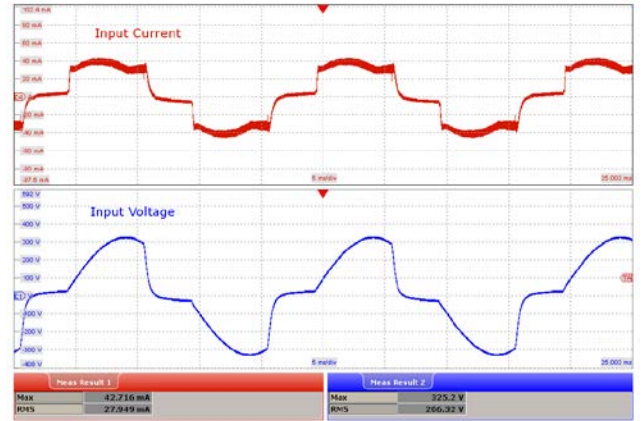

Figure 80 – 120° Conduction Angle.
 Upper: I_{IN} , 20 mA / div.
 Lower: V_{IN} , 100 V / div., 5 ms / div.
 Peak V_{IN} : 325.2 V.
 V_{RMS} : 206.32 V.



Figure 81 – 90° Conduction Angle.
 Upper: I_{IN} , 20 mA / div.
 Lower: V_{IN} , 100 V / div., 5 ms / div.
 Peak V_{IN} : 325.2 V.
 V_{RMS} : 162.39 V



Figure 82 – 52° Conduction Angle.
 Upper: I_{IN} , 20 mA / div.
 Lower: V_{IN} , 100 V / div., 5 ms / div.
 Peak V_{IN} : 242.2V.
 V_{RMS} : 85.304 V



14.4 Output Current Waveforms – Trailing Edge Dimmer

Input: 230 VAC, 50 Hz
 Output: 30 V LED load
 Dimmer: GIRA 0307 00-102

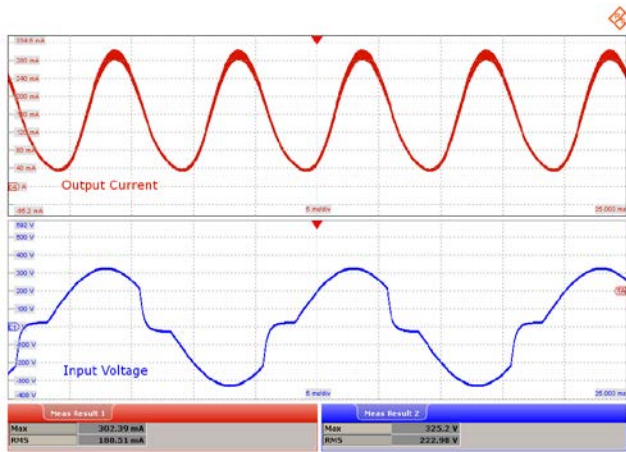

Figure 83 – 145° Conduction Angle.
 Upper: I_{OUT}, 40 mA / div.
 Lower: V_{IN}, 100 V / div., 5 ms / div.
 Peak I_{OUT}: 302.39 mA
 Peak V_{IN}: 325.2 V.

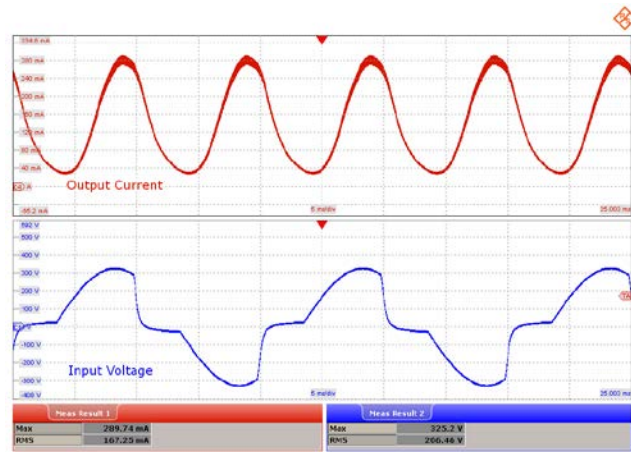

Figure 84 – 120° Conduction Angle.
 Upper: I_{OUT}, 40 mA / div.
 Lower: V_{IN}, 100 V / div., 5 ms / div.
 Peak I_{OUT}: 289.74 mA
 Peak V_{IN}: 325.2 V.

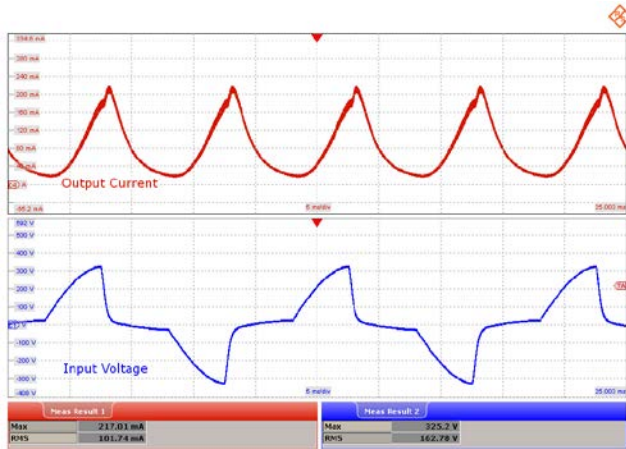

Figure 85 – 90° Conduction Angle.
 Upper: I_{OUT}, 40 mA / div.
 Lower: V_{IN}, 100 V / div., 5 ms / div.
 Peak I_{OUT}: 217.01 mA
 Peak V_{IN}: 325.2 V.

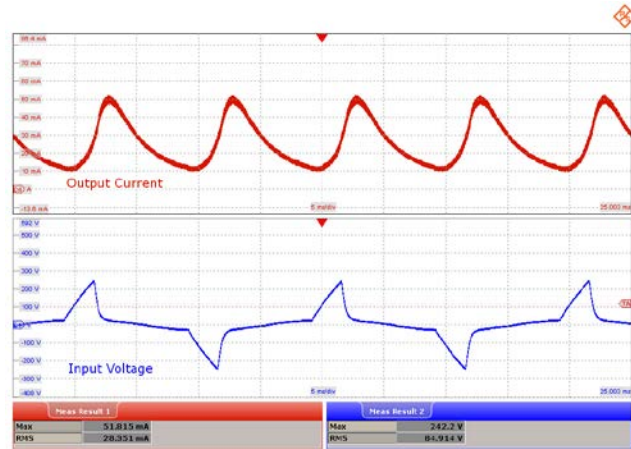

Figure 86 – 45° Conduction Angle.
 Upper: I_{OUT}, 10 mA / div.
 Lower: V_{IN}, 100 V / div., 5 ms / div.
 Peak I_{OUT}: 51.815 mA
 Peak V_{IN}: 242.2 V.

15 AC Cycling Test

No output current overshoot was observed during on - off cycling.

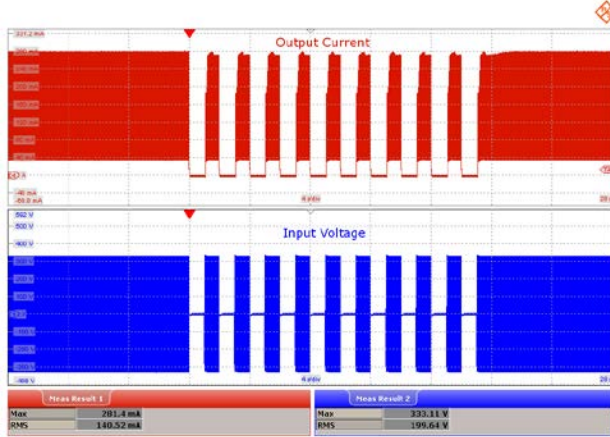

Figure 87 – 230 VAC, 30 V LED Load.
 1 s On – 1 s Off.
 Upper: I_{OUT} , 40 mA / div.
 Lower: V_{IN} , 100 V / div., 4 s / div.
 Peak I_{OUT} : 281.4 mA.
 Peak V_{IN} : 333.11 V.

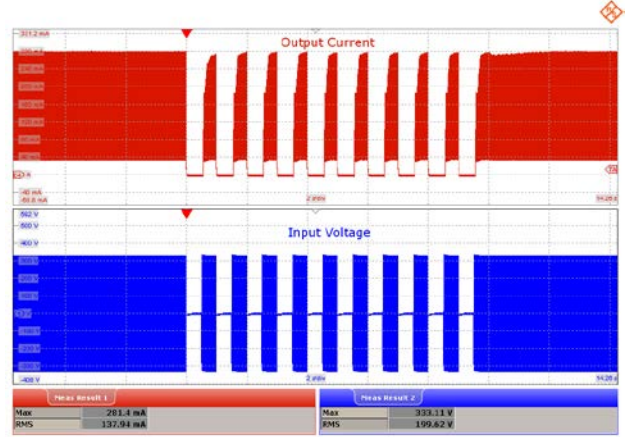

Figure 88 – 230 VAC, 30 V LED Load.
 500 ms On – 500 ms Off.
 Upper: I_{OUT} , 40 mA / div.
 Lower: V_{IN} , 100 V / div., 2 s / div.
 Peak I_{OUT} : 281.4 mA.
 Peak V_{IN} : 333.11 V.



16 Conducted EMI

16.1 Test Set-up

16.1.1 Equipment and Load Used

1. Rohde and Schwarz ENV216 two line V-network.
2. Rohde and Schwarz ESRP EMI test receiver.
3. Hioki 3322 power hitester.
4. Chroma measurement test fixture.
5. 30 V LED load (a Philips 12.5 W E27 220 V – 240 V LED bulb cool daylight converted into a 30 V LED load) with input voltage set at 230 VAC.

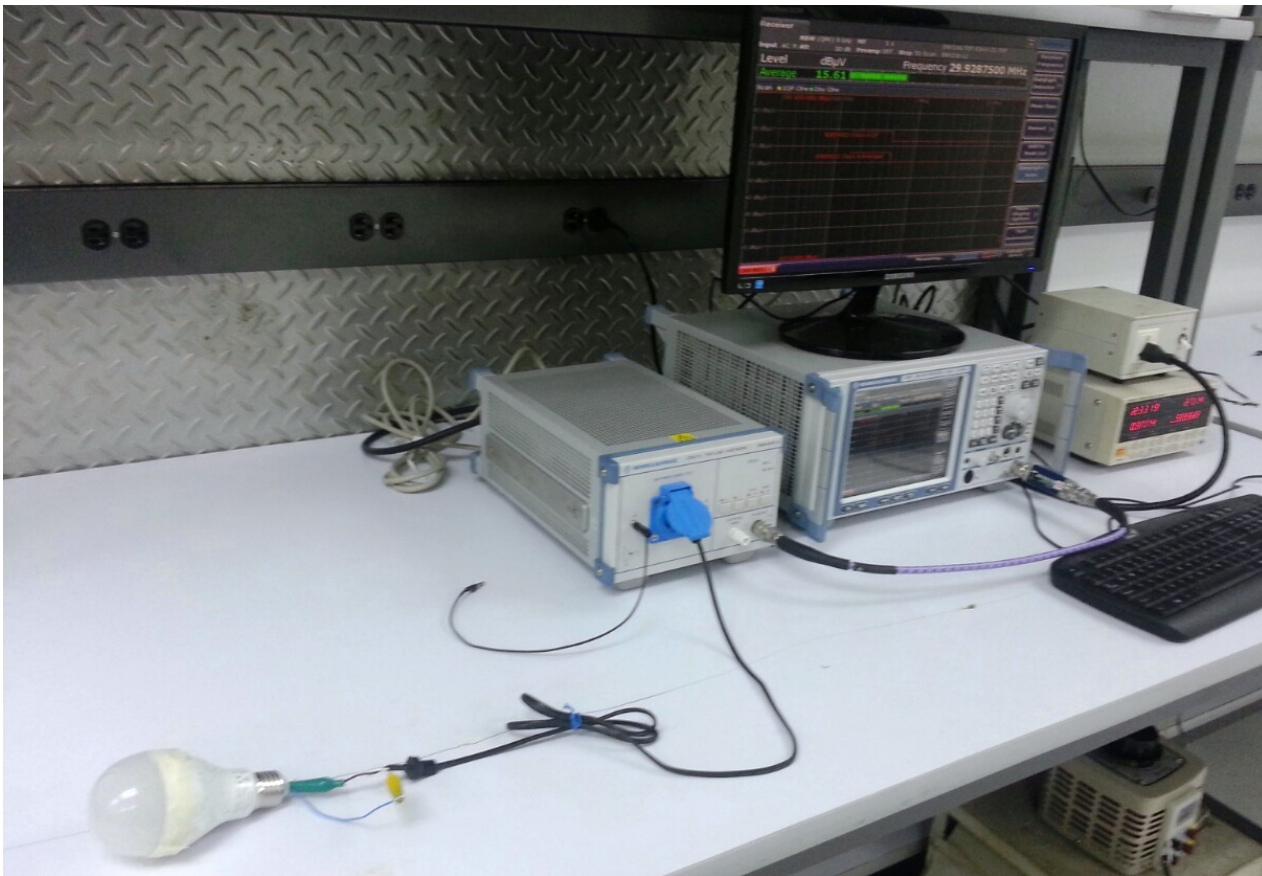

Figure 89 – Conducted EMI Test Set-up.

16.2 EMI Test Result

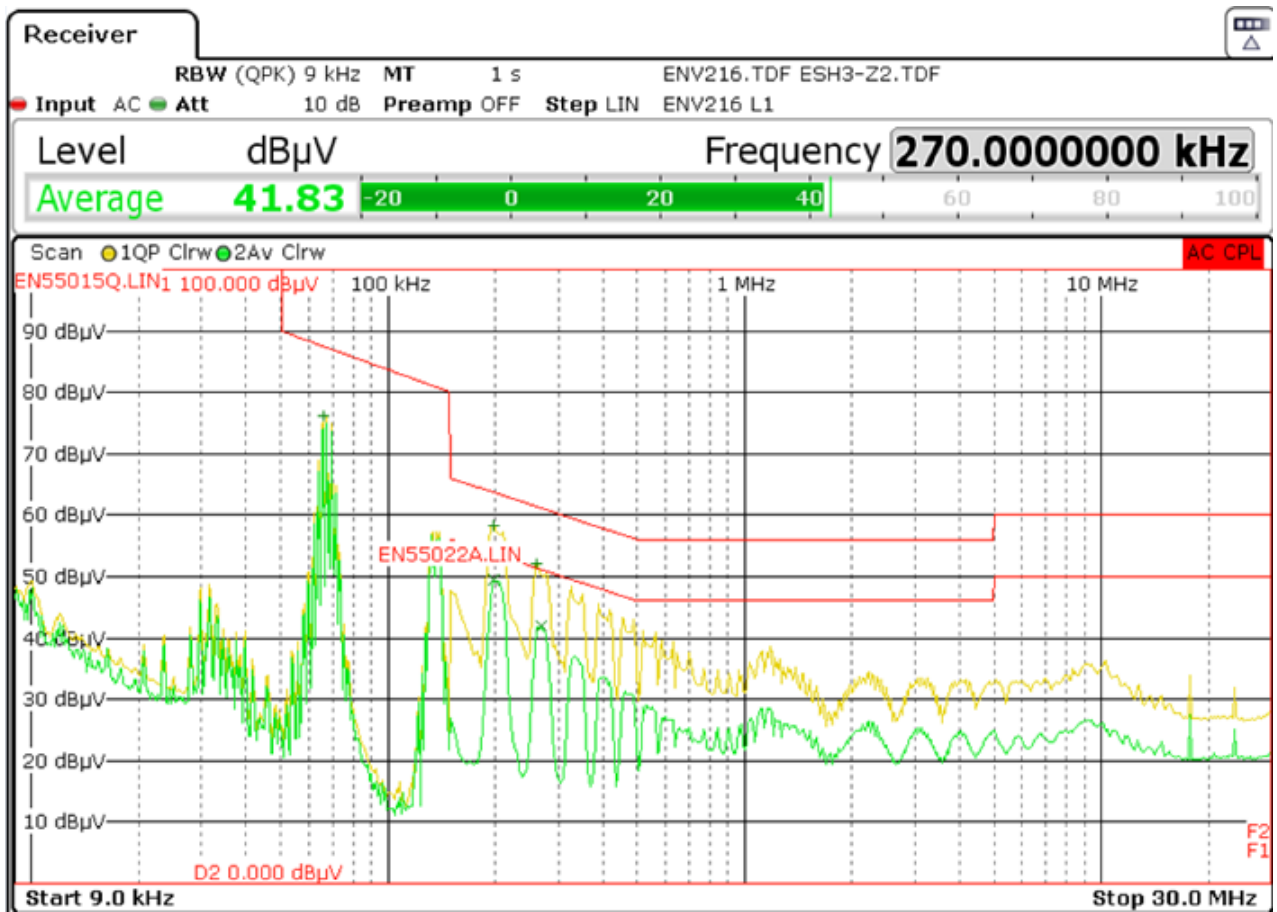

Figure 90 – Conducted EMI, 30 V LED Load, 230 VAC, 50 Hz, and EN55015 B Limits.

Trace/Detector	Frequency	Level dBµV	DeltaLimit
1 Quasi Peak	65.6400 kHz	76.16 N	-11.36 dB
1 Quasi Peak	198.0000 kHz	58.18 N	-5.51 dB
2 Average	198.0000 kHz	49.55 L1	-4.14 dB
1 Quasi Peak	262.0000 kHz	51.97 N	-9.40 dB
2 Average	270.0000 kHz	41.88 L1	-9.24 dB

Figure 91 – Conducted EMI at Line 1, 30 V LED Load, Final Measurement Results.

17 Line Surge

The unit was subjected to ± 2500 V, 100 kHz ring wave and ± 1000 V differential surge using 10 strikes at each condition. A test failure was defined as a non-recoverable interruption of output requiring repair or recycling of input voltage.

Surge Level (V)	Input Voltage (VAC)	Injection Location	Injection Phase (°)	Test Result (Pass/Fail)
+1000	230	L to N	0	Pass
-1000	230	L to N	0	Pass
+1000	230	L to N	90	Pass
-1000	230	L to N	90	Pass

Surge Level (V)	Input Voltage (VAC)	Injection Location	Injection Phase (°)	Test Result (Pass/Fail)
+2500	230	L to N	0	Pass
-2500	230	L to N	0	Pass
+2500	230	L to N	90	Pass
-2500	230	L to N	90	Pass

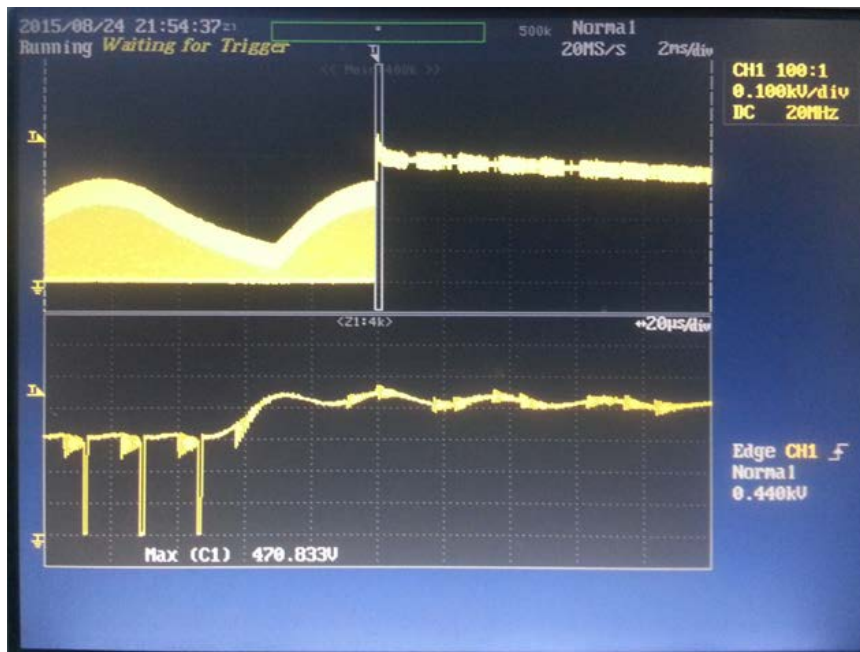

Figure 92 – +1000 kV Differential Surge, 90° Phase.
 LOWER: V_{DRAIN} , 100 V / div., 20 μ s / div.
 Peak V_{DRAIN} : 470.833 V.

18 Brown-in/Brown-out Test

No failure of any component was seen during the brownout test of 0.5 V / sec AC cut-in and cut-off.

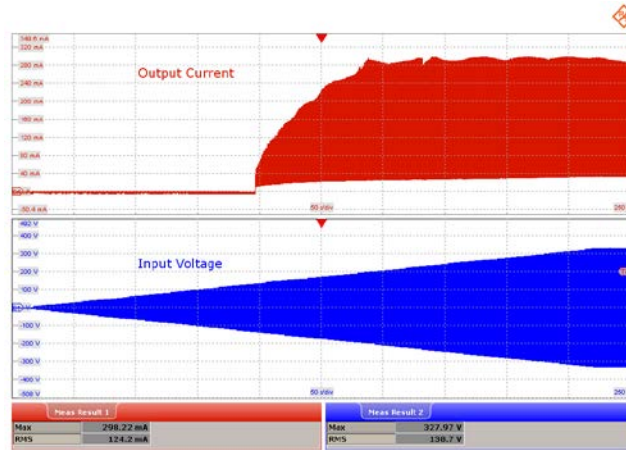

Figure 93 – Brown-in Test at 0.5 V / s, 230 VAC.
 The unit is able to operate normally without any failure and without flicker.
 Upper: I_{OUT}, 40 mA / div.
 Lower: V_{IN}, 100 V / div.
 Time Scale: 50 s / div.

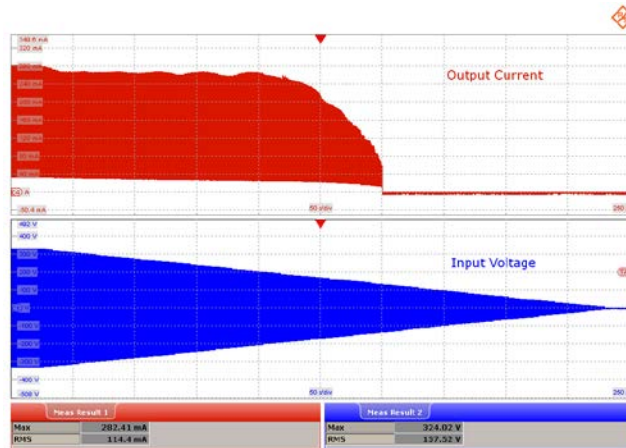

Figure 94 – Brown-out Test at 1 V / s, 230 VAC.
 The unit is able to operate normally without any failure and without flicker.
 Upper: I_{OUT}, 40 mA / div.
 Lower: V_{IN}, 100 V / div.
 Time Scale: 50 s / div.

19 Revision History

Date	Author	Revision	Description and Changes	Reviewed
08-Apr-16	AO	1.0	Initial release	Apps & Mktg



For the latest updates, visit our website: www.power.com

Power Integrations reserves the right to make changes to its products at any time to improve reliability or manufacturability. Power Integrations does not assume any liability arising from the use of any device or circuit described herein. POWER INTEGRATIONS MAKES NO WARRANTY HEREIN AND SPECIFICALLY DISCLAIMS ALL WARRANTIES INCLUDING, WITHOUT LIMITATION, THE IMPLIED WARRANTIES OF MERCHANTABILITY, FITNESS FOR A PARTICULAR PURPOSE, AND NON-INFRINGEMENT OF THIRD PARTY RIGHTS.

Patent Information

The products and applications illustrated herein (including transformer construction and circuits' external to the products) may be covered by one or more U.S. and foreign patents, or potentially by pending U.S. and foreign patent applications assigned to Power Integrations. A complete list of Power Integrations' patents may be found at www.power.com. Power Integrations grants its customers a license under certain patent rights as set forth at <http://www.power.com/ip.htm>.

The PI Logo, TOPSwitch, TinySwitch, LinkSwitch, LYTSwitch, InnoSwitch, DPA-Switch, PeakSwitch, CAPZero, SENZero, LinkZero, HiperPFS, HiperTFS, HiperLCS, Qspeed, EcoSmart, Clampless, E-Shield, Filterfuse, FluxLink, StackFET, PI Expert and PI FACTS are trademarks of Power Integrations, Inc. Other trademarks are property of their respective companies. ©Copyright 2015 Power Integrations, Inc.

Power Integrations Worldwide Sales Support Locations**WORLD HEADQUARTERS**

5245 Hellyer Avenue
San Jose, CA 95138, USA.
Main: +1-408-414-9200
Customer Service:
Phone: +1-408-414-9665
Fax: +1-408-414-9765
e-mail: usasales@power.com

GERMANY

Lindwurmstrasse 114
80337, Munich
Germany
Phone: +49-895-527-39110
Fax: +49-895-527-39200
e-mail: eurosales@power.com

JAPAN

Kosei Dai-3 Building
2-12-11, Shin-Yokohama,
Kohoku-ku, Yokohama-shi,
Kanagawa 222-0033
Japan
Phone: +81-45-471-1021
Fax: +81-45-471-3717
e-mail: japansales@power.com

TAIWAN

5F, No. 318, Nei Hu Rd.,
Sec. 1
Nei Hu District
Taipei 11493, Taiwan R.O.C.
Phone: +886-2-2659-4570
Fax: +886-2-2659-4550
e-mail:
taiwansales@power.com

CHINA (SHANGHAI)

Rm 2410, Charity Plaza, No. 88,
North Caoxi Road,
Shanghai, PRC 200030
Phone: +86-21-6354-6323
Fax: +86-21-6354-6325
e-mail: chinasales@power.com

INDIA

#1, 14th Main Road
Vasanthanagar
Bangalore-560052
India
Phone: +91-80-4113-8020
Fax: +91-80-4113-8023
e-mail: indiasales@power.com

KOREA

RM 602, 6FL
Korea City Air Terminal B/D,
159-6
Samsung-Dong, Kangnam-Gu,
Seoul, 135-728 Korea
Phone: +82-2-2016-6610
Fax: +82-2-2016-6630
e-mail: koreasales@power.com

UK

Cambridge Semiconductor,
a Power Integrations company
Westbrook Centre, Block 5,
2nd Floor
Milton Road
Cambridge CB4 1YG
Phone: +44 (0) 1223-446483
e-mail: eurosales@power.com

CHINA (SHENZHEN)

17/F, Hivac Building, No. 2, Keji
Nan 8th Road, Nanshan District,
Shenzhen, China, 518057
Phone: +86-755-8672-8689
Fax: +86-755-8672-8690
e-mail: chinasales@power.com

ITALY

Via Milanese 20, 3rd. Fl.
20099 Sesto San Giovanni (MI)
Italy
Phone: +39-024-550-8701
Fax: +39-028-928-6009
e-mail: eurosales@power.com

SINGAPORE

51 Newton Road,
#19-01/05 Goldhill Plaza
Singapore, 308900
Phone: +65-6358-2160
Fax: +65-6358-2015
e-mail: singaporesales@power.com

