



Design Example Report

Title	<i>High Efficiency (>90%), Power Factor Corrected, 7.2 W Output LED Driver Using LinkSwitch™-PL LNK460VG</i>
Specification	185 VAC – 265 VAC Input; 36 V _{TYP} , 200 mA Output
Application	A19 LED Driver
Author	Application Engineering Department
Document Number	DER-303
Date	January 11, 2012
Revision	1.0

Summary and Features

- Single-stage power factor correction combined with constant current (CC) output
- Highly energy efficient, >90%
- Low cost, low component count, small size and single-sided PCB
- Integrated protection, reliability and lifetime features
 - Single shot no-load protection / output short-circuit protected with auto-recovery
 - Auto-recovering thermal shutdown with large hysteresis protects both components and PCB
 - No damage during brown-out conditions
 - No aluminum electrolytic bulk capacitor
- PF >0.9 at 230 VAC, EN6000-3-2 Class D compliant
- % ATHD <20% at 230 VAC; 36 V LED
- Meets IEC ring wave, differential line surge and EN55015 conducted EMI
- Protected in case of open-circuit load
- For TRIAC dimmable version see DER-302

PATENT INFORMATION

The products and applications illustrated herein (including transformer construction and circuits external to the products) may be covered by one or more U.S. and foreign patents, or potentially by pending U.S. and foreign patent applications assigned to Power Integrations. A complete list of Power Integrations' patents may be found at www.powerint.com. Power Integrations grants its customers a license under certain patent rights as set forth at <http://www.powerint.com/ip.htm>.

Table of Contents

1	Introduction.....	4
2	Power Supply Specification	5
3	Schematic.....	6
4	Circuit Description	7
4.1	Input EMI Filtering	7
4.2	Power Circuit.....	7
4.3	Output Feedback.....	7
4.4	Open Load Protection	8
5	PCB Layout	9
6	Bill of Materials	10
7	Inductor Specification	11
7.1	Electrical Diagram	11
7.2	Electrical Specifications.....	11
7.3	Materials.....	11
7.4	Inductor Build Diagram.....	11
7.5	Inductor Construction	11
8	Performance Data	12
8.1	Efficiency.....	12
8.2	Line and Load Regulation.....	13
8.3	Power Factor	14
8.4	A-THD	15
8.5	Harmonics	16
8.5.1	11 LED Load	16
8.5.2	12 LED Load	17
8.5.3	13 LED Load	18
8.6	Test Data.....	19
8.6.1	Test Data, 11 LED Load.....	19
8.6.2	Test Data, 12 LED Load.....	19
8.6.3	Test Data, 13 LED Load.....	19
8.6.4	230 VAC 50 Hz, 11 LED Load Harmonics Data	20
8.6.5	230 VAC 50 Hz, 12 LED Load Harmonics Data	21
8.6.6	230 VAC 50 Hz, 13 LED Load Harmonics Data	22
9	Thermal Performance.....	23
9.1	$V_{IN} = 185$ VAC, 50 Hz, 36 V LED Load.....	23
9.2	$V_{IN} = 265$ VAC, 60 Hz, 36 V LED Load.....	23
10	Waveforms.....	24
10.1	Input Voltage and Input Current Waveforms	24
10.2	Output Current and Output Voltage at Normal Operation.....	25
10.3	Output Current/Voltage Rise and Fall.....	26
10.4	Input Voltage and Output Current Waveform at Start-up.....	27
10.5	Drain Voltage and Current at Normal Operation.....	28
10.6	Start-up Drain Voltage and Current.....	29
10.7	Output Current and Drain Voltage During Output Short Condition	29
10.8	Open Load Output Voltage.....	30



- 10.9 Brown-in and Brown-out Condition31
- 11 Conducted EMI32
 - 11.1 Test Set-up.....32
 - 11.2 EMI Test Result33
- 12 Line Surge34
 - 12.1 Line Surge Waveform34
 - 12.1.1 500 V 1.2 / 50 μ s Surge Test Drain Waveforms Worst Case.....34
 - 12.1.2 Increasing Differential Sure Withstand to 1 kV34
 - 12.2 Line Surge Summary35
- 13 Revision History36

Important Note: Although this board is designed to satisfy safety isolation requirements, the engineering prototype has not been agency approved. Therefore, all testing should be performed using an isolation transformer to provide the AC input to the prototype board.



1 Introduction

The document describes a non-isolated, high efficiency, high power factor (PF) LED driver designed to drive a nominal LED string voltage of 36 V at 200 mA from an input voltage range of 185 VAC to 265 VAC (47 Hz – 63 Hz). The LED driver utilizes the LNK460VG from the LinkSwitch-PL family of ICs.

The topology used is a single-stage non-isolated buck that meets the stringent space and efficiency requirements for this design. LinkSwitch-PL based designs provide a high power factor (>0.9) meeting international requirements.

This design was not optimized for operation with phase dimmers. If this is a requirement, please see DER-302.

This document contains the LED driver specification, schematic, PCB details, bill of materials, transformer documentation and typical performance characteristics.

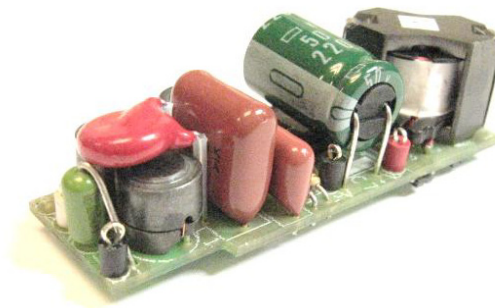

Figure 1 – Populated Circuit Board.

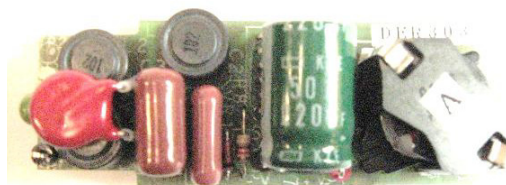

Figure 2 – Populated Circuit Board, Top View.

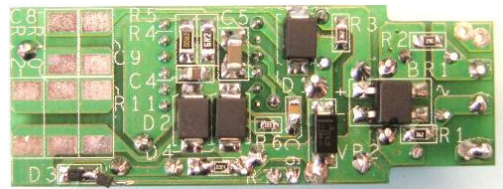

Figure 3 – Populated Circuit Board, Bottom View.



2 Power Supply Specification

The table below represents the minimum acceptable performance of the design. Actual performance is listed in the results section.

Description	Symbol	Min	Typ	Max	Units	Comment
Input Voltage Frequency	V_{IN} f_{LINE}	185	230 50	265	VAC Hz	2 Wire – no P.E.
Output Output Voltage Output Current Total Output Power Continuous Output Power	V_{OUT} I_{OUT} P_{OUT}		36 200 7.2		V mA W	$V_{OUT} = 36\text{ V}$, $V_{IN} = 230\text{ VAC}$, $25\text{ }^{\circ}\text{C}$
Efficiency Full Load	η	90			%	Measured at P_{OUT} $25\text{ }^{\circ}\text{C}$
Environmental Conducted EMI Safety Ring Wave (100 kHz) Differential Mode (L1-L2) Differential Surge						
			CISPR 15B / EN55015B Non-Isolated			
			2.5		kV	
			500		V	1 kV with minor changes. See Section 12.
Power Factor		0.9				Measured at $V_{OUT(TYP)}$, $I_{OUT(TYP)}$ and 230 VAC, 50 Hz
Harmonic Currents			EN 61000-3-2 Class D (C)			Class C specifies Class D Limits when $P_{IN} < 25\text{ W}$
Ambient Temperature	T_{AMB}		50		$^{\circ}\text{C}$	Free convection, sea level



3 Schematic

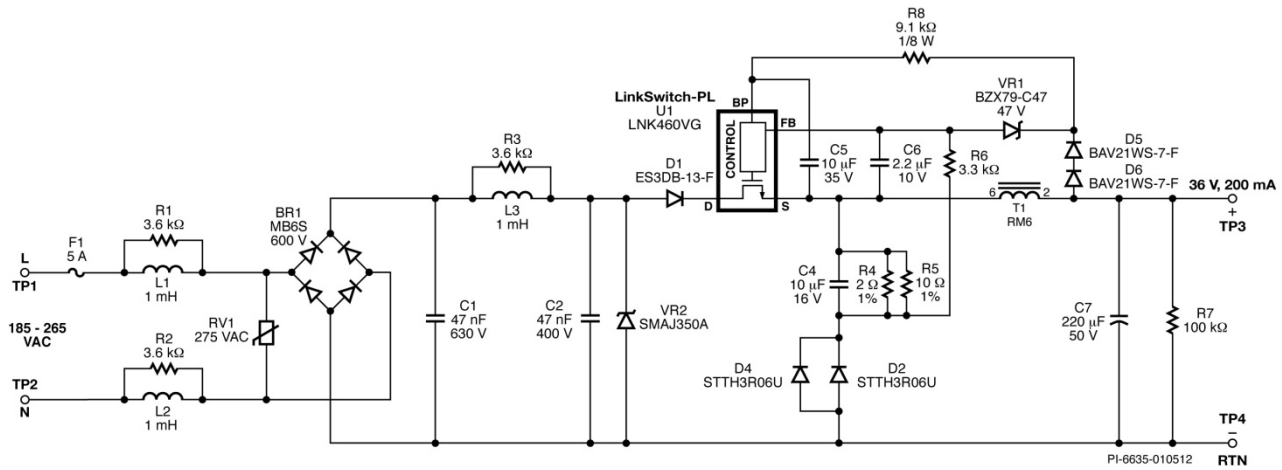

Figure 4 – Schematic.



4 Circuit Description

The LinkSwitch-PL (U1) is a highly integrated primary-side controller intended for use in LED driver applications. The LinkSwitch-PL provides high power factor while regulating the output current across a range of input (185 VAC to 265 VAC) in a single conversion stage. The design also supports the output voltage variations typically encountered in LED driver applications. All of the control circuitry responsible for these functions plus the high-voltage power MOSFET is incorporated into the IC.

4.1 Input EMI Filtering

Inductors L1-L3 and C1-C2 filter the input switching current presented by the buck converter to the line. Resistor R1, R2 and R3 across L1, L2 and L3 damp any resonances between the input inductors, capacitors and the AC line impedance which would otherwise cause peaks in conducted EMI measurements.

MOV RV1 provides a clamp to limit the maximum voltage during differential line surge events. Zener diode VR2 was added to increase immunity to differential line surge. Bridge rectifier BR1 rectifies the AC line voltage with capacitor C2 providing a low impedance path (decoupling) for the switching current. A low value of capacitance (sum of C1 and C2) is necessary to maintain a power factor of greater than 0.9.

4.2 Power Circuit

The circuit is configured as a buck converter with the pin of U1 connected on top of the freewheeling diodes D2 and D4 and DRAIN (D) pin connected to the positive side of the DC rectified input thru D1. Diode D1 is used to prevent reverse current from flowing through U1. An RM6 core size was selected to optimize the inductor for highest system efficiency. Capacitor C7 is selected to give an output current ripple of $\leq \pm 50\%$.

Capacitor C5 provides local decoupling for the BYPASS (BP) pin of U1 which is the supply pin for the internal controller. During start-up, C5 is charged to ~6 V from an internal high-voltage current source connected to the DRAIN pin. At this point U1 starts switching and the operating supply current is also provided from inductor T1 via R8, D5 and D6.

The series combination of D5 and D6 was used to provide very fast recovery and low capacitance. This was required minimize the current pulled out of the FB pin when charging the reverse capacitance of D5 and D6 when U1 power MOSFET is conducting. A single ultrafast diode (UF4005) may be used with the result of slightly poorer output regulation.

4.3 Output Feedback

Resistor R4 and R5 are used to sense the diode current of the buck converter. Its value is adjusted to center the output current at 200 mA at nominal input voltage. Capacitor C4 is used to filter the high frequency component of the diode current which helps improve



overall efficiency. Resistor R6 and C6 provide additional filtering to lower the ripple voltage feed to the FEEDBACK (FB) pin of U1 for improved regulation.

4.4 Open Load Protection

The LED driver is protected in the event of accidental open load operation by monitoring the voltage across the output inductor during energy decay (current flowing in D2 and D4). Zener diode VR1 sets the OVP threshold which forces U1 to enter cycle-skipping mode.

During open load condition, the output capacitor can be charged to a voltage that exceeds the threshold of VR1 because of the leakage current that flows to the output capacitor even when U1 is off. Resistor R7 is used limit the maximum output voltage by partially discharging the output during open load, but with the tradeoff on efficiency during normal operation. This resistor also ensures the LED load quickly turns off when AC is removed.

For designs which require absolute OVP protection for the output capacitor, a Zener diode with Zener voltage greater than or equal to VR1 Zener voltage can be added across the output.



Want More?

Use your smartphone and free software from www.neoreader.com (or any other free QR Code Reader from your smartphone's App Store) and you will be connected to related content



5 PCB Layout

The PCB used is the same as DER-302 with R13 replaced by F1 and TRIAC dimmer interface components not populated.

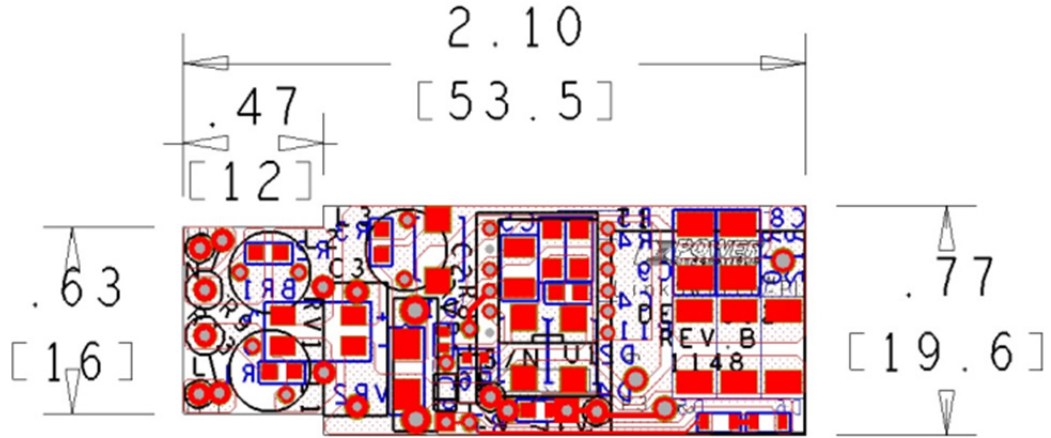

Figure 5 – PCB Layout and Outline (in/[mm]).

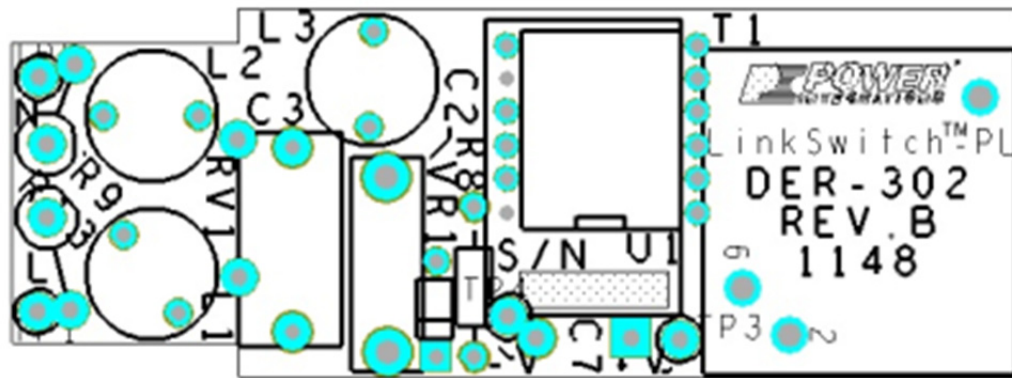

Figure 6 – Top Side.

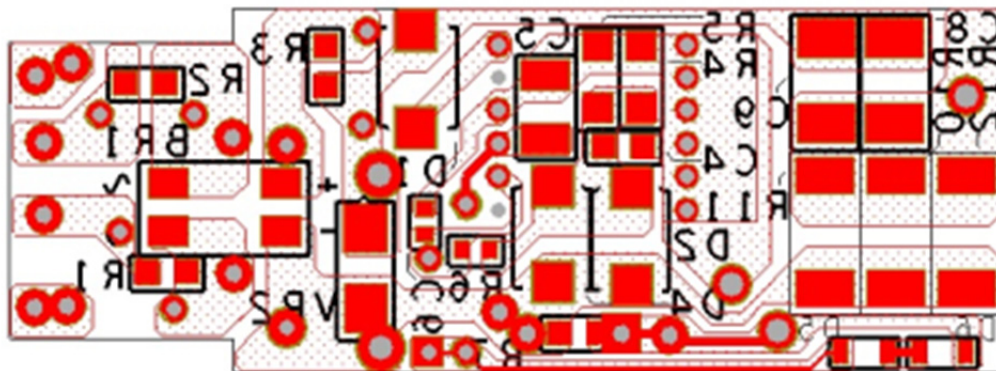

Figure 7 – Bottom Side.

Note: In revision A of the PCB, D5 and D6 are located in the location marked D3.



6 Bill of Materials

Item	Qty	Ref Des	Description	Mfg Part Number	Mfg
1	1	BR1	600 V, 0.5 A, Bridge Rectifier, SMD, MBS-1, 4-SOIC	MB6S-TP	Micro Commercial
2	1	C1	47 nF, 630 V, Film	ECQ-E6473KF	Panasonic
3	1	C2	47 nF, 400 V, Film	ECQ-E4473KF	Panasonic
4	1	C4	10 μ F, 16 V, Ceramic, X5R, 0805	GRM21BR61C106KE15L	Murata
5	1	C5	10 μ F, 35 V, Ceramic, Y5V, 1210	GMK325F106ZH-T	Taiyo Yuden
6	1	C6	2.2 μ F, 10 V, Ceramic, X5R, 0603	GRM188R61A225KE34D	Murata
7	1	C7	220 μ F, 50 V, Electrolytic, (10 x 16)	EKZE500ELL221MJ16S	Nippon Chemi-Con
8	1	D1	200 V, 3 A, DIODE SUPER FAST SMD, SMB	ES3DB-13-F	Diodes, Inc.
9	2	D2 D4	600 V, 3 A, Fast Recovery, 35 ns, SMB Case	STTH3R06U	ST Micro
10	2	D5, D6	250 V, 0.2 A, Fast Switching, 50 ns, SOD-323	BAV21WS-7-F	Diodes, Inc.
11	1	F1	5 A, 250 V, Fast, Microfuse, Axial	0263005.MXL	Littlefuse
12	3	L1 L2 L3	1 mH, 0.23 A, Ferrite Core	CTSCH875DF-102K	CT Parts
13	3	R1 R2 R3	3.6 k Ω , 5%, 1/8 W, Thick Film, 0805	ERJ-6GEYJ362V	Panasonic
14	1	R4	2.00 Ω , 1%, 1/4 W, Thick Film, 1206	MCR18EZHFL2R00	Rohm Semi
15	1	R5	10 Ω , 1%, 1/4 W, Thick Film, 1206	ERJ-8ENF10R0V	Panasonic
16	1	R6	3.3 k Ω , 5%, 1/10 W, Thick Film, 0603	ERJ-3GEYJ332V	Panasonic
17	1	R7	100 k, 5%, 1/8 W, Thick Film, 0805	ERJ-6GEYJ104V	Panasonic
18	1	R8	9.1 k Ω , 5%, 1/8 W, Carbon Film	CFR-12JB-9K1	Yageo
19	1	RV1	275 V, 23 J, 7 mm, RADIAL	V275LA4P	Littlefuse
20	1	T1	Bobbin, RM6, Vertical, 6 pins	B65808-N1006-D1	Epcos
21	1	U1	LinkSwitch-PL, eDIP-12P	LNK460VG	Power Integrations
22	1	VR1	47 V, 500 mW, 5%, DO-35	BZX79-C47	Taiwan Semi
23	1	VR2	350 V, 400 W, 5%, DO214AC (SMA)	SMAJ350A	Littlefuse



7 Inductor Specification

7.1 Electrical Diagram

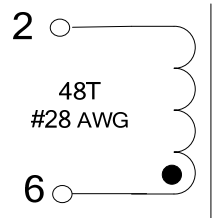

Figure 8 – Inductor Electrical Diagram.

7.2 Electrical Specifications

Primary Inductance	Pins 2-6, all other windings open, measured at 100 kHz, 0.4 V _{RMS}	360 μH ±7%
Resonant Frequency	Pins 2-6, all other windings open	2 MHz (Min.)

7.3 Materials

Item	Description
[1]	Core: TDKPC95RM06-Z.
[2]	Bobbin: B-RM6-V-6pins-(3/3) with mounting clip, CLIP-RM6.
[3]	Tape, Polyester film, 3M 1350F-1 or equivalent, 6.4 mm wide.
[4]	Wire: Magnet, #28 AWG, solderable double coated.

7.4 Inductor Build Diagram

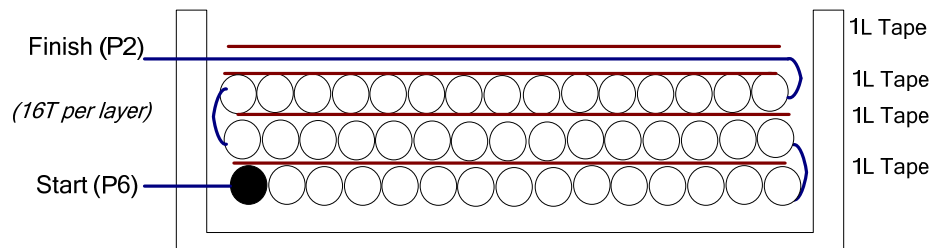

Figure 9 – Inductor Build Diagram.

7.5 Inductor Construction

Bobbin Preparation	Place the bobbin item [2] on the mandrel such that pin side on the left side. Winding direction is the clockwise direction.
WDG 1	Starting at pin 6, wind 48 turns of wire item [4] in three layers. Apply one layer of tape item [3] per layer. Finish at pin 2.
Final Assembly	Grind core to get 0.36 mH inductance.



8 Performance Data

All measurements performed at room temperature using an LED load. The following data were measured using 3 sets of loads to represent the load range of 33 V ~ 39 V output voltage). Refer to the table on Section 8.6 for the complete set of test data values.

8.1 Efficiency

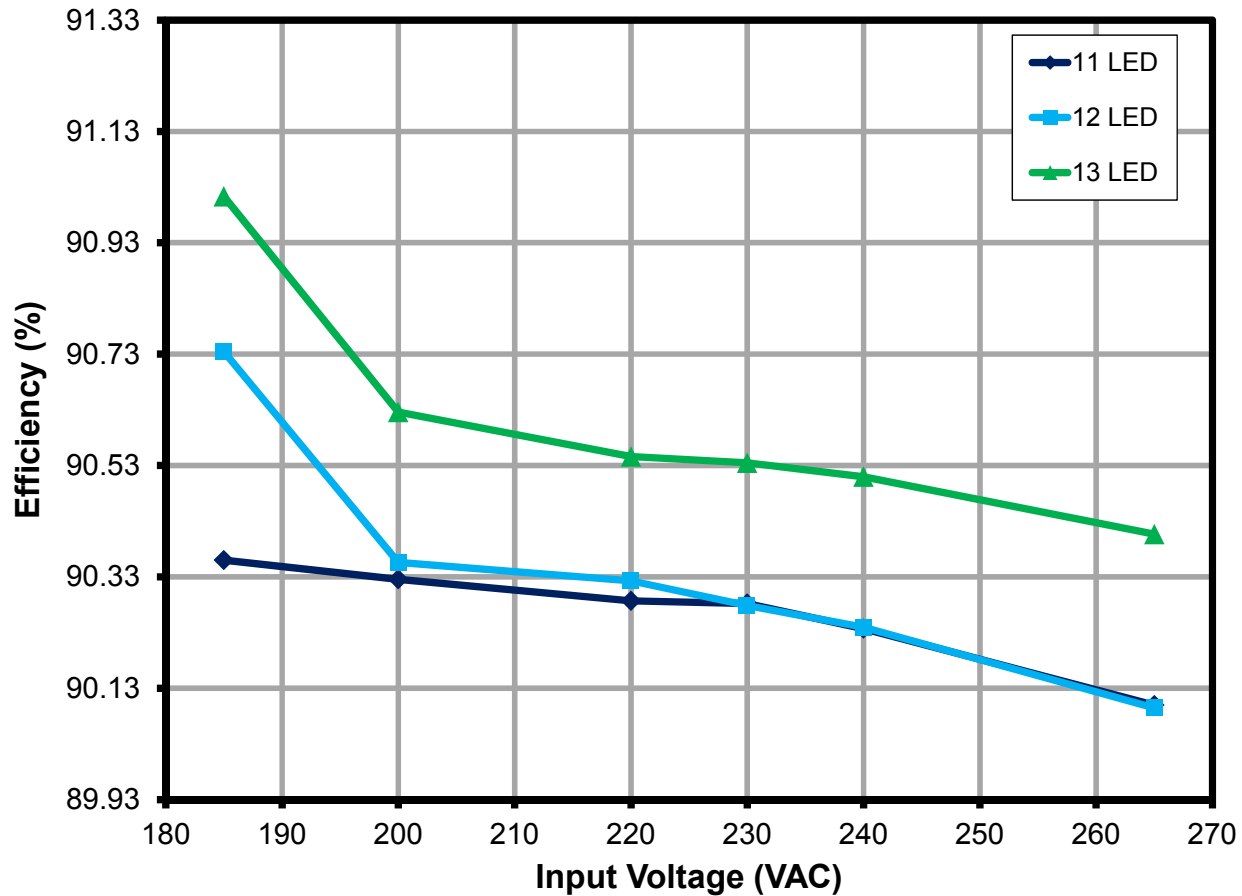

Figure 10 – Efficiency vs. Line and Load.



8.2 Line and Load Regulation

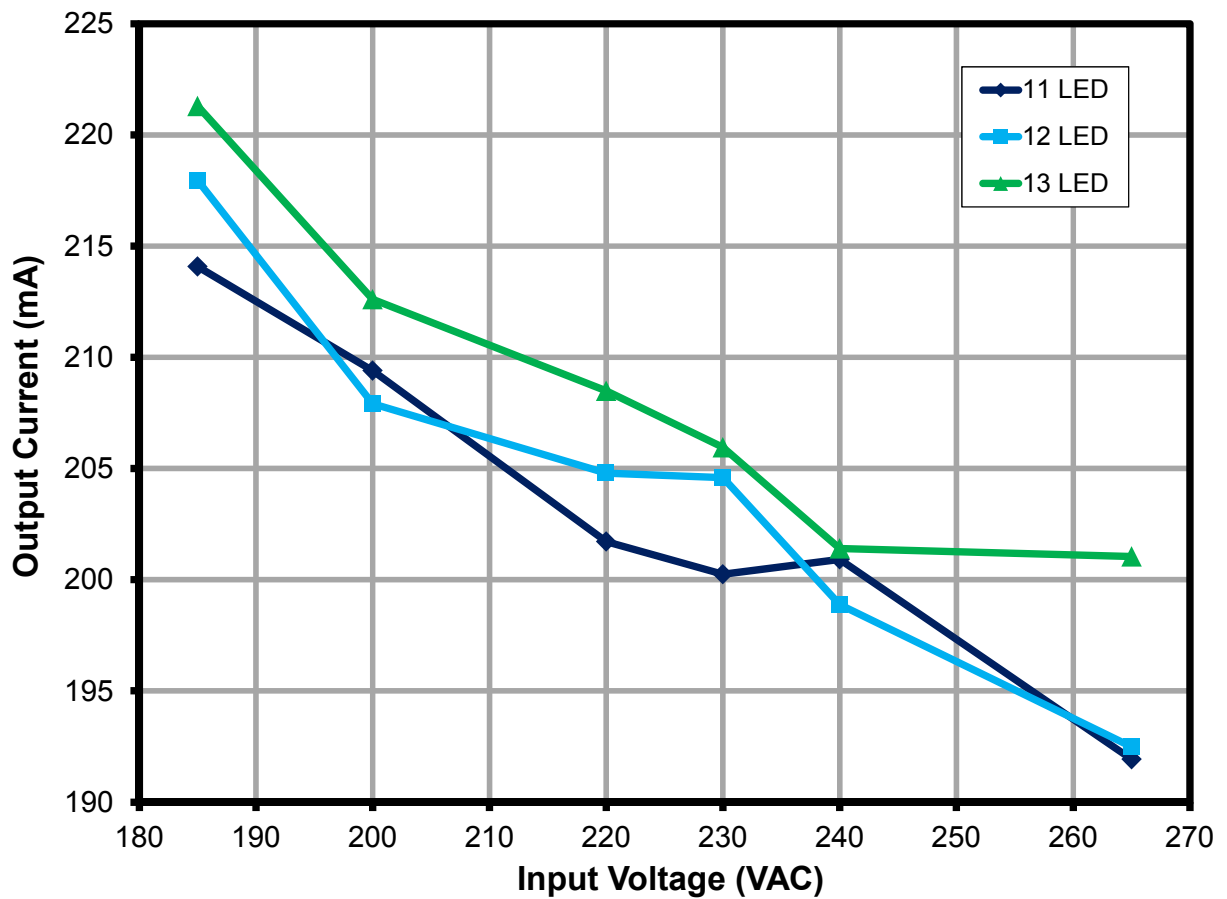

Figure 11 – Regulation vs. Line and Load.



8.3 Power Factor

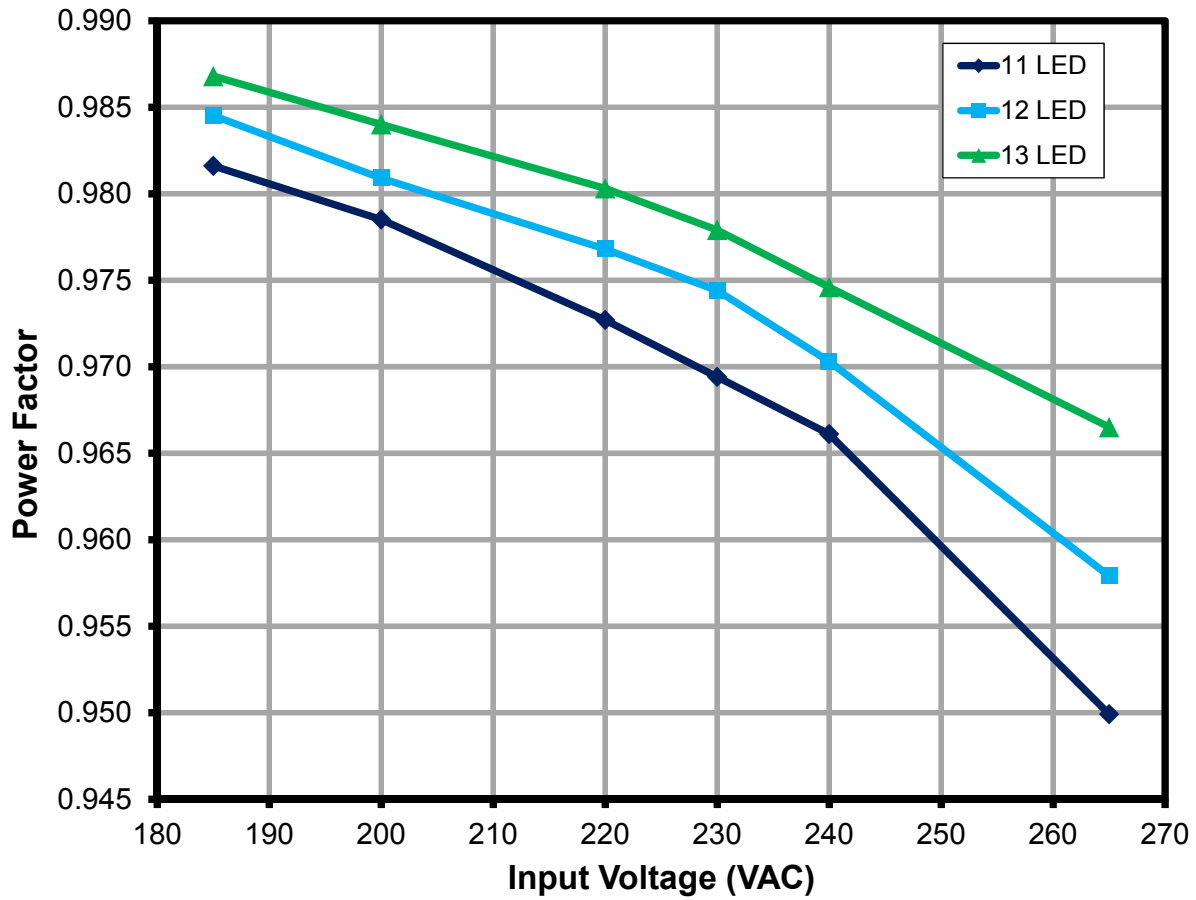

Figure 12 – Power Factor vs. Line and Load.



8.4 A-THD

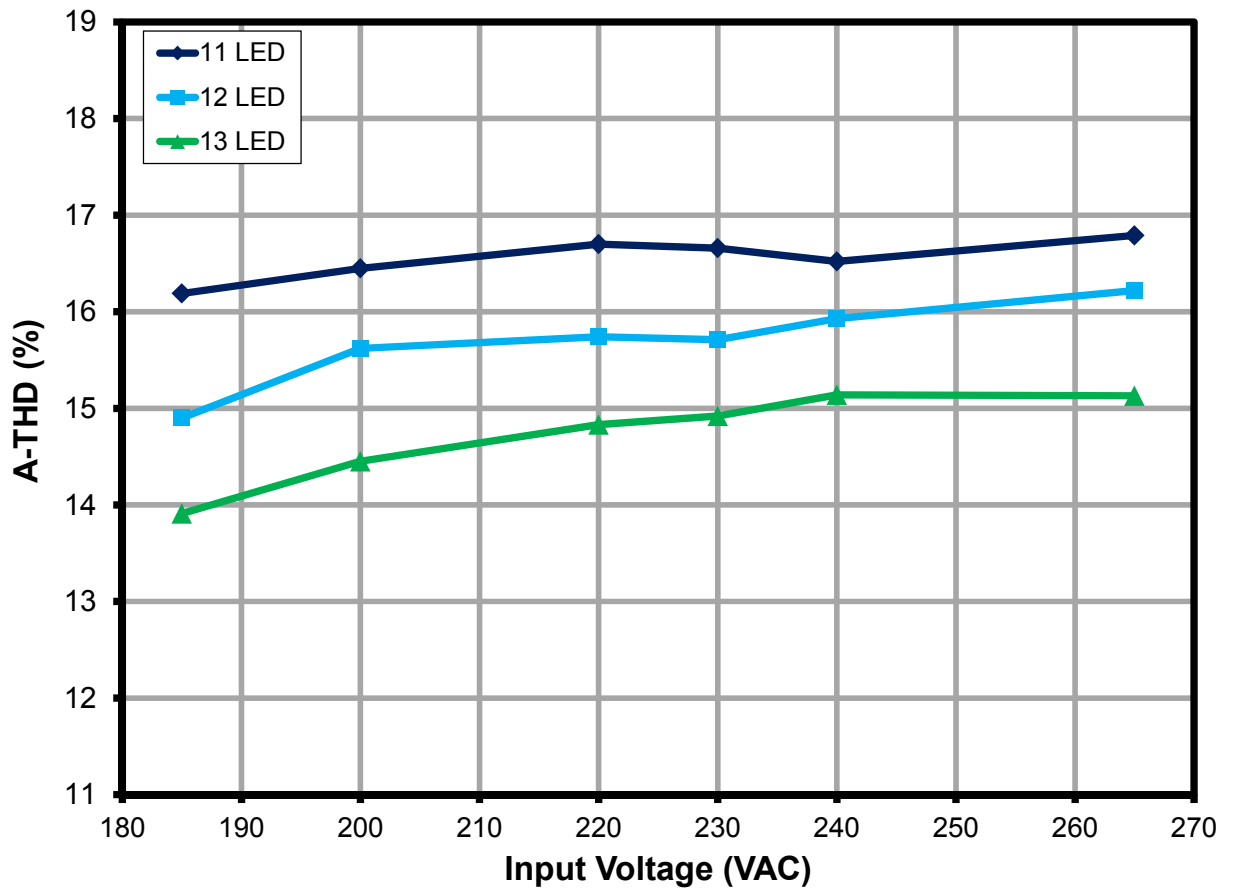

Figure 13 – A-THD vs. Line and Load.



8.5 Harmonics

The design met the limits for Class C equipment for an active input power of <25 W. In this case IEC61000-3-2 specifies that harmonic currents shall not exceed the limits of Class D equipment¹. Therefore the limits shown in the charts below are Class D limits which must not be exceeded to meet Class C compliance.

8.5.1 11 LED Load

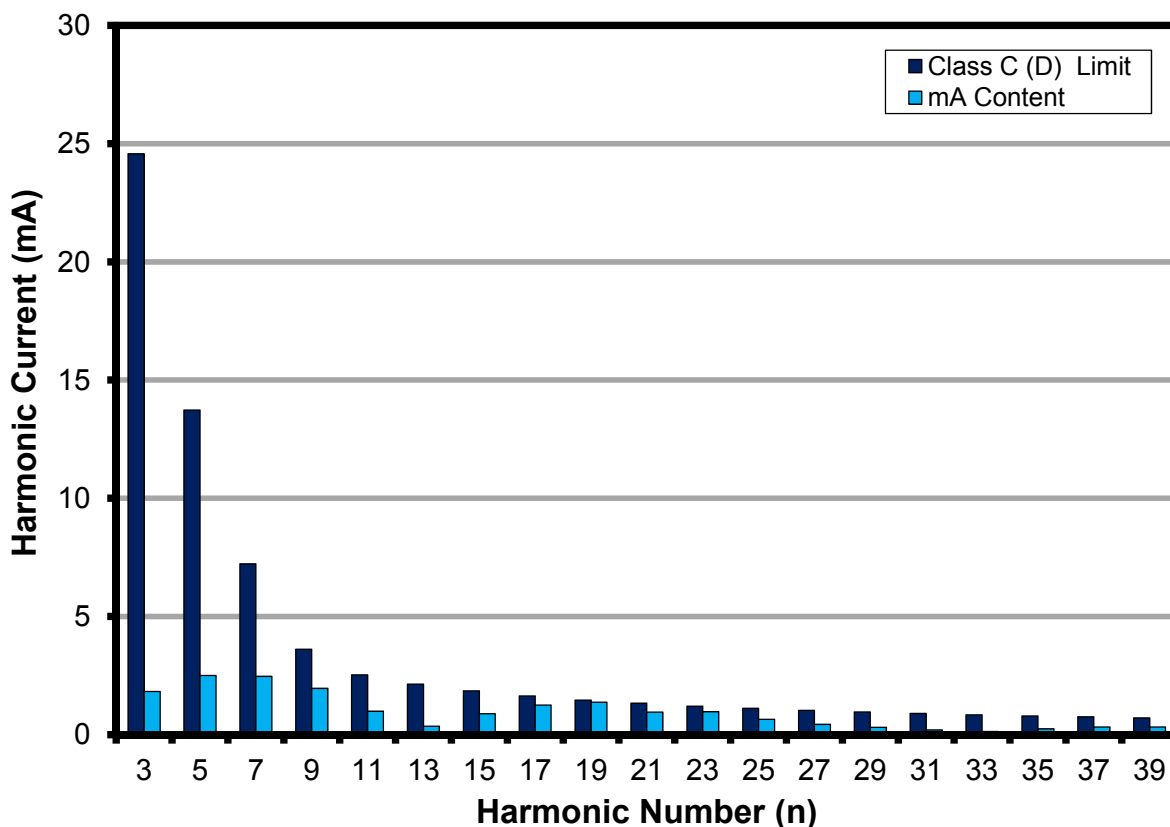

Figure 14 – 11 LED Load Input Current Harmonics at 230 VAC, 50 Hz.

¹ IEC6000-3-2 Section 7.3, table 2, column 2.



8.5.2 12 LED Load

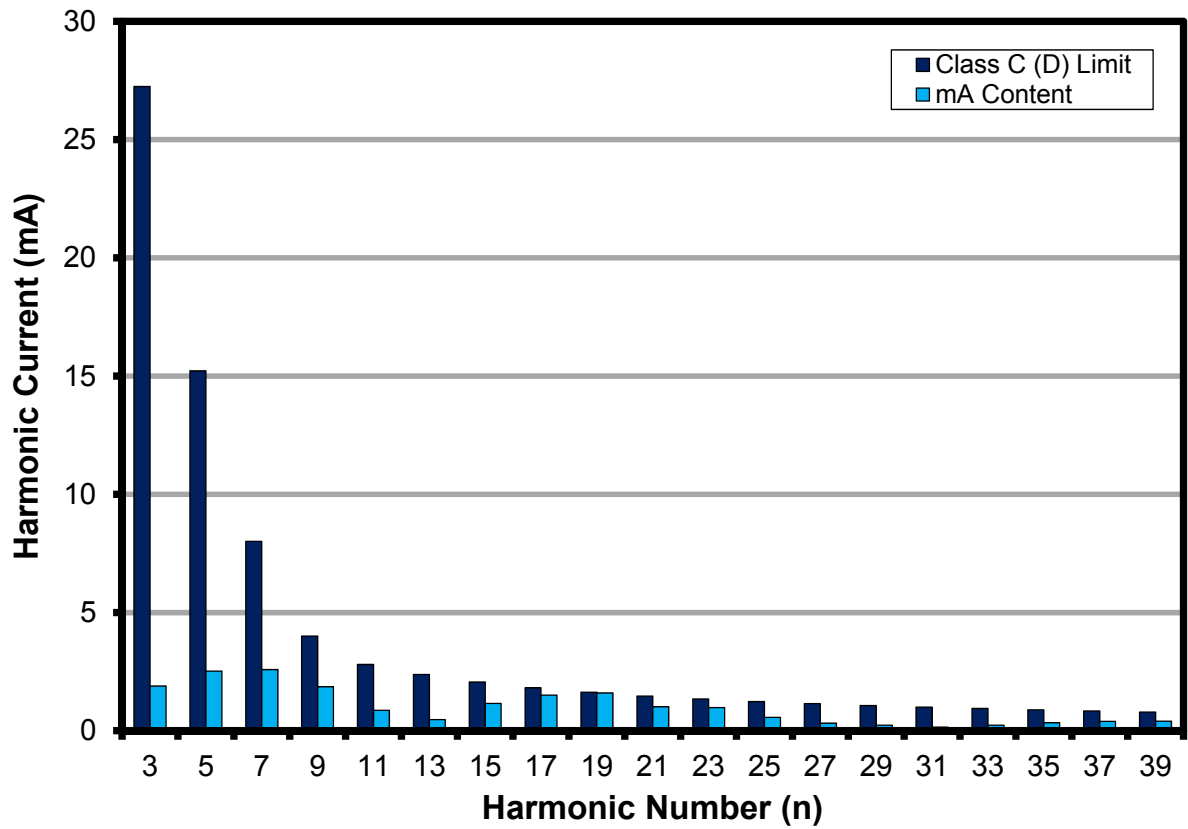

Figure 15 – 12 LED Load Input Current Harmonics at 230 VAC, 50 Hz.



8.5.3 13 LED Load

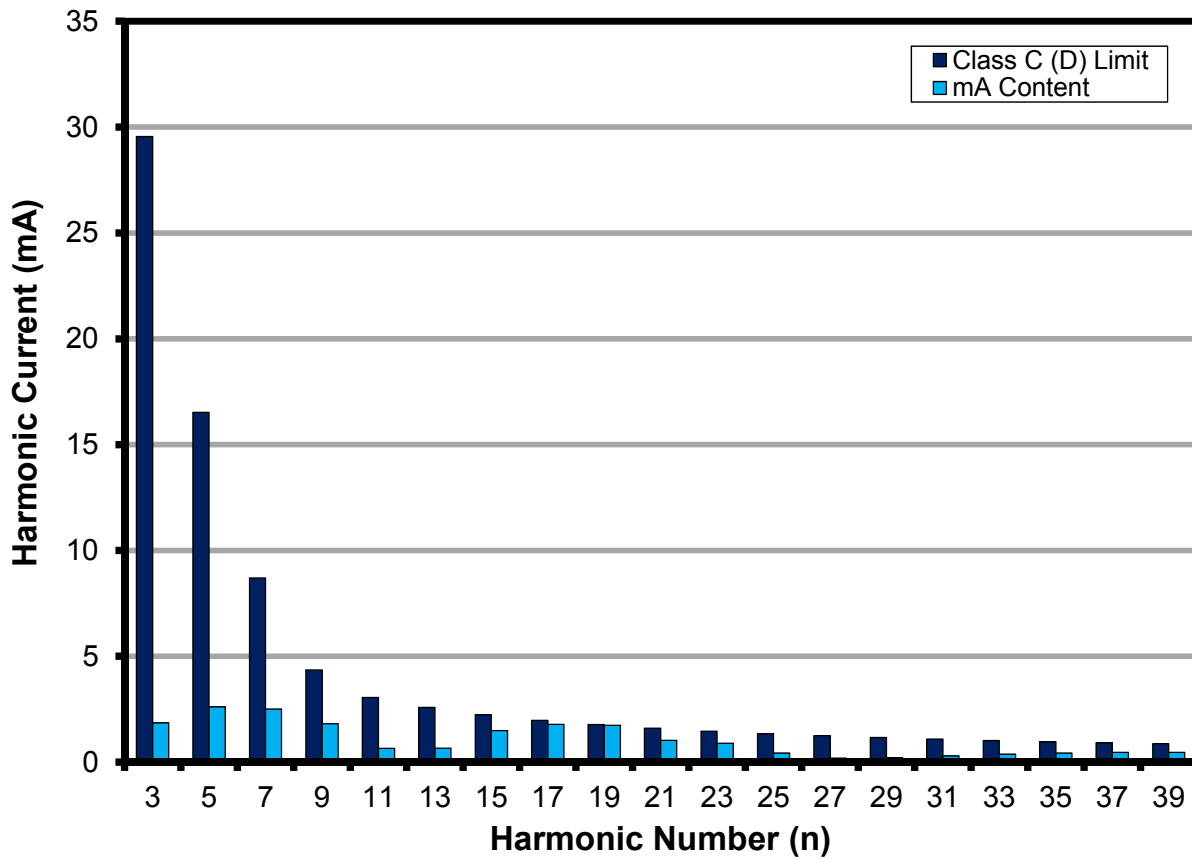

Figure 16 – 13 LED Load Input Current Harmonics at 230 VAC, 50 Hz.



8.6 Test Data

All measurements were taken with the board at open frame, 25 °C ambient, and 50 Hz line frequency.

8.6.1 Test Data, 11 LED Load

Input Measurement					Load Measurement			Calculation		
V _{IN} (V _{RMS})	I _{IN} (mA _{RMS})	P _{IN} (W)	PF	%ATHD	V _{OUT} (V _{DC})	I _{OUT} (mA _{DC})	P _{OUT} (W)	P _{CAL} (W)	Efficiency (%)	Loss (W)
185.04	42.77	7.770	0.982	16.19	32.48	214.08	7.02	6.95	90.36	0.75
200.08	38.75	7.585	0.979	16.45	32.42	209.40	6.85	6.79	90.33	0.73
220.10	34.03	7.287	0.973	16.7	32.33	201.71	6.58	6.52	90.29	0.71
230.16	32.40	7.228	0.969	16.66	32.30	200.24	6.53	6.47	90.28	0.70
240.12	31.28	7.256	0.966	16.52	32.30	200.91	6.55	6.49	90.24	0.71
265.14	27.47	6.919	0.950	16.79	32.21	191.92	6.23	6.18	90.10	0.69

8.6.2 Test Data, 12 LED Load

Input Measurement					Load Measurement			Calculation		
V _{IN} (V _{RMS})	I _{IN} (mA _{RMS})	P _{IN} (W)	PF	%ATHD	V _{OUT} (V _{DC})	I _{OUT} (mA _{DC})	P _{OUT} (W)	P _{CAL} (W)	Efficiency (%)	Loss (W)
185.03	47.01	8.564	0.985	14.9	35.33	217.96	7.77	7.70	90.73	0.79
200.07	41.53	8.150	0.981	15.62	35.12	207.91	7.36	7.30	90.36	0.79
220.09	37.30	8.019	0.977	15.74	35.07	204.79	7.24	7.18	90.32	0.78
230.15	35.73	8.013	0.974	15.71	35.06	204.59	7.23	7.17	90.28	0.78
240.11	33.38	7.776	0.970	15.93	35.00	198.88	7.02	6.96	90.24	0.76
265.13	29.61	7.521	0.958	16.22	34.93	192.48	6.78	6.72	90.09	0.75

8.6.3 Test Data, 13 LED Load

Input Measurement					Load Measurement			Calculation		
V _{IN} (V _{RMS})	I _{IN} (mA _{RMS})	P _{IN} (W)	PF	%ATHD	V _{OUT} (V _{DC})	I _{OUT} (mA _{DC})	P _{OUT} (W)	P _{CAL} (W)	Efficiency (%)	Loss (W)
185.03	51.35	9.376	0.987	13.91	38.24	221.30	8.53	8.46	91.01	0.84
200.07	45.68	8.993	0.984	14.45	38.03	212.61	8.15	8.08	90.63	0.84
220.10	40.84	8.811	0.980	14.83	37.97	208.49	7.98	7.92	90.55	0.83
230.15	38.63	8.695	0.978	14.92	37.93	205.95	7.87	7.81	90.53	0.82
240.12	36.29	8.493	0.975	15.14	37.88	201.40	7.69	7.63	90.51	0.81
265.14	33.11	8.485	0.967	15.13	37.87	201.04	7.67	7.61	90.41	0.81



8.6.4 230 VAC 50 Hz, 11 LED Load Harmonics Data

V	Freq	I (mA)	P	PF	%THD
230	50.00	32.40	7.2280	0.9694	16.66
nth Order	mA Content	% Content	Limit <25 W	Limit >25 W	Remarks
1	31.90				
2	0.02	0.06%		2.00%	
3	1.83	5.74%	24.5752	29.08%	Pass
5	2.51	7.86%	13.7332	10.00%	Pass
7	2.47	7.74%	7.2280	7.00%	Pass
9	1.96	6.13%	3.6140	5.00%	Pass
11	0.99	3.10%	2.5298	3.00%	Pass
13	0.36	1.13%	2.1406	3.00%	Pass
15	0.88	2.77%	1.8552	3.00%	Pass
17	1.26	3.94%	1.6369	3.00%	Pass
19	1.37	4.30%	1.4646	3.00%	Pass
21	0.96	2.99%	1.3251	3.00%	Pass
23	0.97	3.05%	1.2099	3.00%	Pass
25	0.66	2.05%	1.1131	3.00%	Pass
27	0.44	1.38%	1.0307	3.00%	Pass
29	0.31	0.98%	0.9596	3.00%	Pass
31	0.20	0.62%	0.8977	3.00%	Pass
33	0.14	0.43%	0.8433	3.00%	Pass
35	0.24	0.76%	0.7951	3.00%	Pass
37	0.32	1.02%	0.7521	3.00%	Pass
39	0.33	1.03%	0.7135	3.00%	Pass
41	0.26	0.81%			
43	0.22	0.70%			
45	0.27	0.83%			
47	0.29	0.91%			
49	0.28	0.89%			



8.6.5 230 VAC 50 Hz, 12 LED Load Harmonics Data

V	Freq	I (mA)	P	PF	%THD
230	50.00	35.73	8.0130	0.9744	15.71
nth Order	mA Content	% Content	Limit <25 W	Limit >25 W	Remarks
1	35.26				
2	0.01	0.03%		2.00%	
3	1.89	5.36%	27.2442	29.23%	Pass
5	2.52	7.15%	15.2247	10.00%	Pass
7	2.59	7.34%	8.0130	7.00%	Pass
9	1.86	5.26%	4.0065	5.00%	Pass
11	0.86	2.45%	2.8046	3.00%	Pass
13	0.47	1.34%	2.3731	3.00%	Pass
15	1.16	3.28%	2.0567	3.00%	Pass
17	1.50	4.27%	1.8147	3.00%	Pass
19	1.59	4.52%	1.6237	3.00%	Pass
21	1.01	2.86%	1.4691	3.00%	Pass
23	0.98	2.78%	1.3413	3.00%	Pass
25	0.56	1.60%	1.2340	3.00%	Pass
27	0.31	0.89%	1.1426	3.00%	Pass
29	0.23	0.66%	1.0638	3.00%	Pass
31	0.15	0.43%	0.9952	3.00%	Pass
33	0.24	0.68%	0.9349	3.00%	Pass
35	0.34	0.96%	0.8814	3.00%	Pass
37	0.40	1.13%	0.8338	3.00%	Pass
39	0.40	1.14%	0.7910	3.00%	Pass
41	0.28	0.78%			
43	0.28	0.80%			
45	0.31	0.88%			
47	0.26	0.74%			
49	0.30	0.84%			



8.6.6 230 VAC 50 Hz, 13 LED Load Harmonics Data

V	Freq	I (mA)	P	PF	%THD
230	50.00	38.63	8.6950	0.9779	14.92
nth Order	mA Content	% Content	Limit <25 W	Limit >25 W	Remarks
1	38.17				
2	0.02	0.04%		2.00%	
3	1.85	4.84%	29.5630	29.34%	Pass
5	2.61	6.84%	16.5205	10.00%	Pass
7	2.50	6.56%	8.6950	7.00%	Pass
9	1.81	4.74%	4.3475	5.00%	Pass
11	0.64	1.68%	3.0433	3.00%	Pass
13	0.66	1.72%	2.5751	3.00%	Pass
15	1.48	3.88%	2.2317	3.00%	Pass
17	1.77	4.65%	1.9692	3.00%	Pass
19	1.73	4.54%	1.7619	3.00%	Pass
21	1.03	2.69%	1.5941	3.00%	Pass
23	0.88	2.31%	1.4555	3.00%	Pass
25	0.42	1.11%	1.3390	3.00%	Pass
27	0.18	0.47%	1.2398	3.00%	Pass
29	0.21	0.54%	1.1543	3.00%	Pass
31	0.29	0.75%	1.0799	3.00%	Pass
33	0.37	0.97%	1.0144	3.00%	Pass
35	0.43	1.12%	0.9565	3.00%	Pass
37	0.46	1.19%	0.9048	3.00%	Pass
39	0.45	1.18%	0.8584	3.00%	Pass
41	0.33	0.87%			
43	0.28	0.73%			
45	0.35	0.93%			
47	0.29	0.75%			
49	0.15	0.38%			



9 Thermal Performance

Images captured after running for >30 minutes at room temperature (25 °C), open frame for the conditions specified.

9.1 $V_{IN} = 185 \text{ VAC}, 50 \text{ Hz}, 36 \text{ V LED Load}$

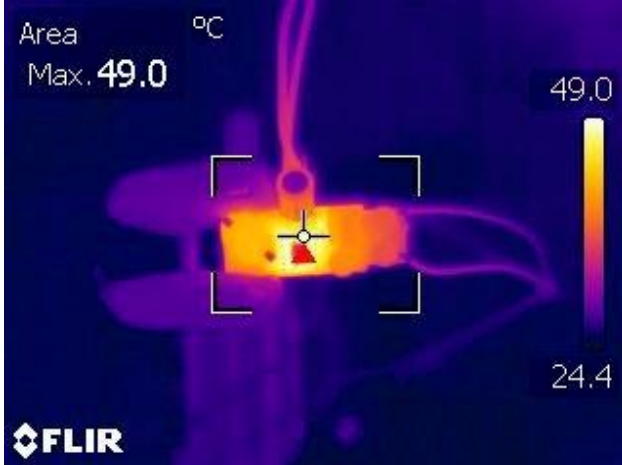

Figure 17 – Top Side.
U1- LNK460VG: 49 °C.

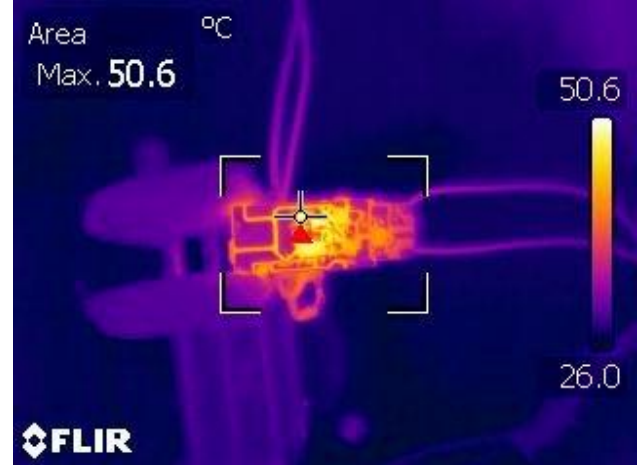

Figure 18 – Bottom Side.
R4- Current Sense Resistor: 50.6 °C.

9.2 $V_{IN} = 265 \text{ VAC}, 60 \text{ Hz}, 36 \text{ V LED Load}$

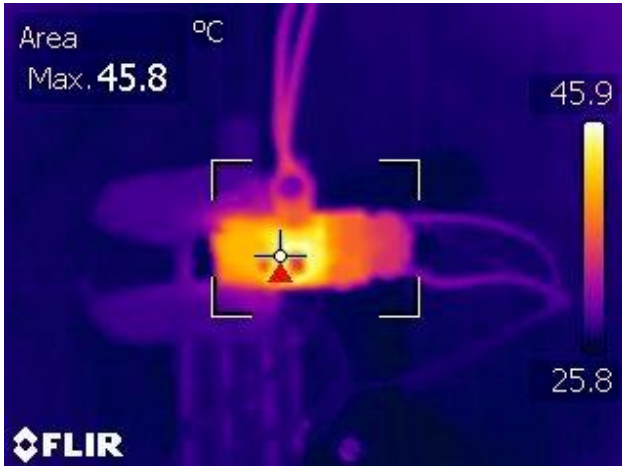

Figure 19 – Top Side.
U1- LNK460VG: 45.8 °C.

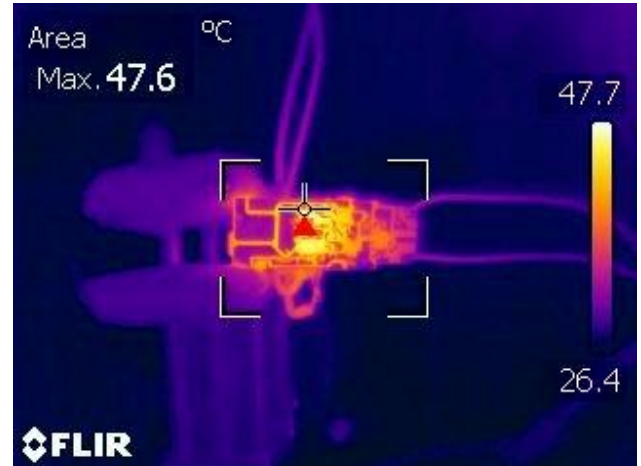

Figure 20 – Bottom Side.
R4- Current Sense Resistor: 47.6 °C.



10 Waveforms

10.1 Input Voltage and Input Current Waveforms

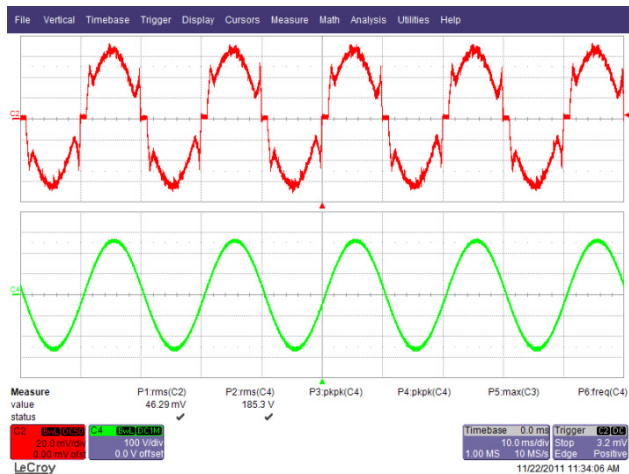

Figure 21 – 185 VAC, Full Load.
 Upper: I_{IN} , 20 mA / div.
 Lower: V_{IN} , 100 V, 10 ms / div.

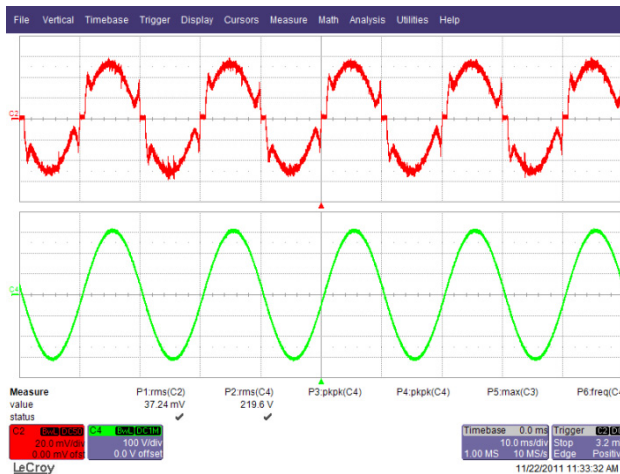

Figure 22 – 220 VAC, Full Load.
 Upper: I_{IN} , 20 mA / div.
 Lower: V_{IN} , 100 V, 10 ms / div.

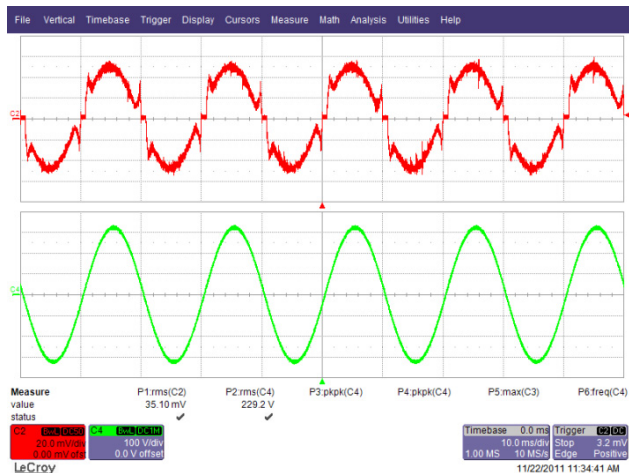

Figure 23 – 230 VAC, Full Load.
 Upper: I_{IN} , 20 mA / div.
 Lower: V_{IN} , 100 V, 10 ms / div.

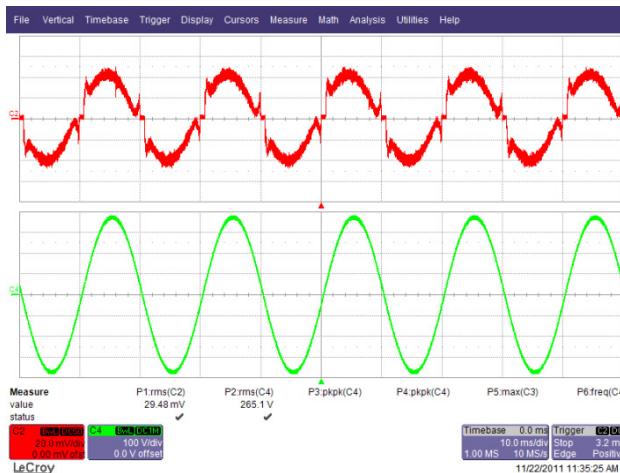

Figure 24 – 265 VAC, Full Load.
 Upper: I_{IN} , 20 mA / div.
 Lower: V_{IN} , 100 V, 10 ms / div.



10.2 Output Current and Output Voltage at Normal Operation

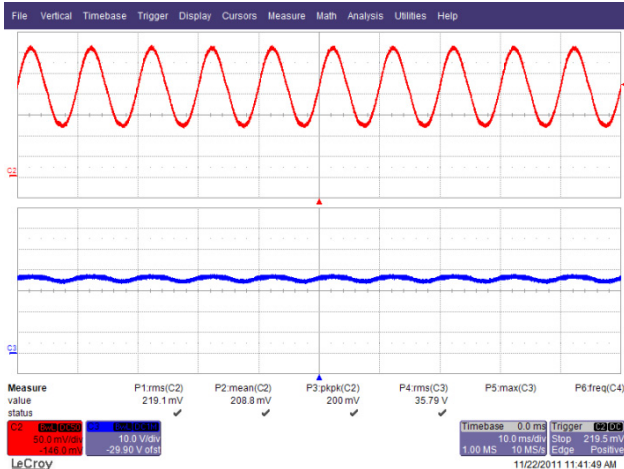

Figure 25 – 185 VAC, 50 Hz Full Load.
Upper: I_{OUT} , 50 mA / div.
Lower: V_{OUT} , 10 V, 10 ms / div.

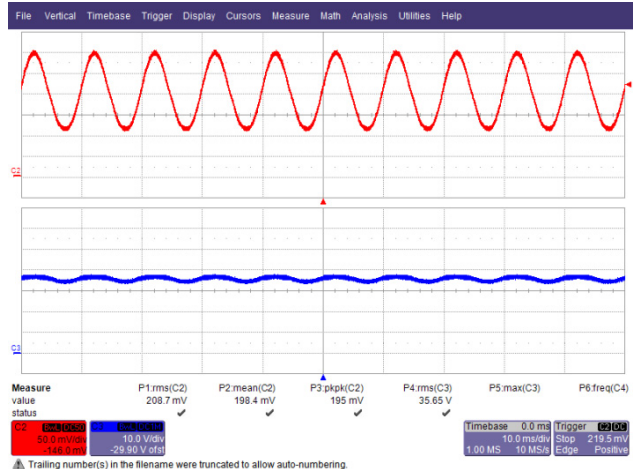

Figure 26 – 220 VAC, 50 Hz Full Load.
Upper: I_{OUT} , 50 mA / div.
Lower: V_{OUT} , 10 V, 10 ms / div.

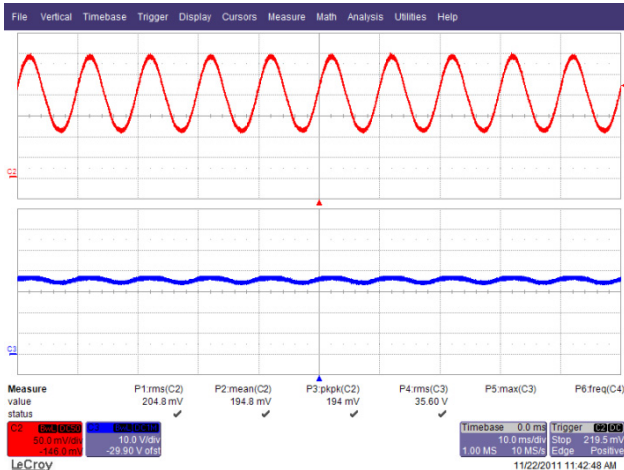

Figure 27 – 230 VAC, 50 Hz Full Load.
Upper: I_{OUT} , 50 mA / div.
Lower: V_{OUT} , 10 V, 10 ms / div.

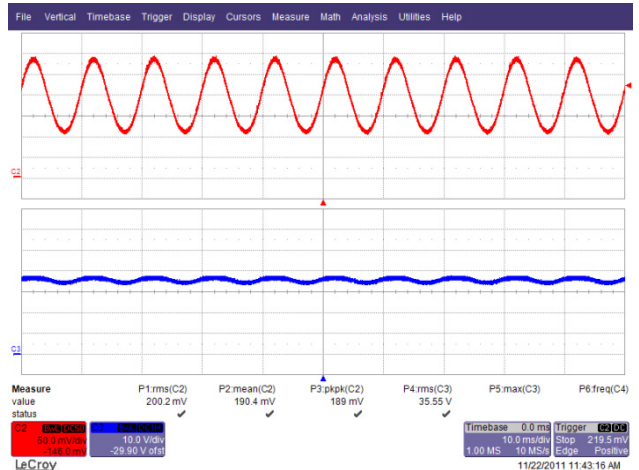

Figure 28 – 265 VAC, 50 Hz Full Load.
Upper: I_{OUT} , 50 mA / div.
Lower: V_{OUT} , 10 V, 10 ms / div.



10.3 Output Current/Voltage Rise and Fall

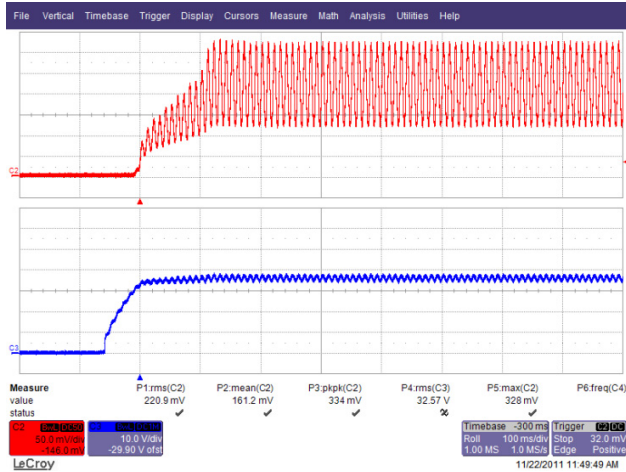

Figure 29 – 185 VAC Output Rise.
 Upper: I_{OUT} , 50 mA / div.
 Lower: V_{OUT} , 10 V, 100 ms / div.

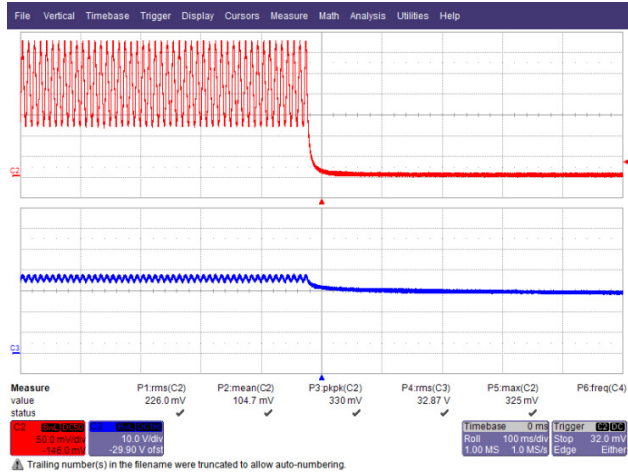

Figure 30 – 185 VAC Output Fall.
 Upper: I_{OUT} , 50 mA / div.
 Lower: V_{OUT} , 10 V, 100 ms / div.

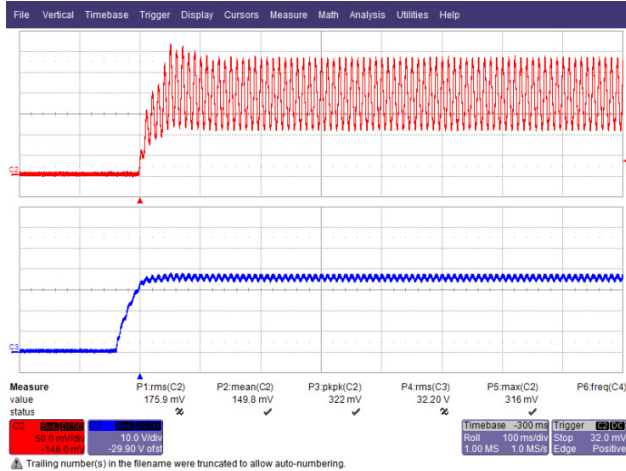

Figure 31 – 265 VAC Output Rise.
 Upper: I_{OUT} , 50 mA / div.
 Lower: V_{OUT} , 10 V, 100 ms / div.

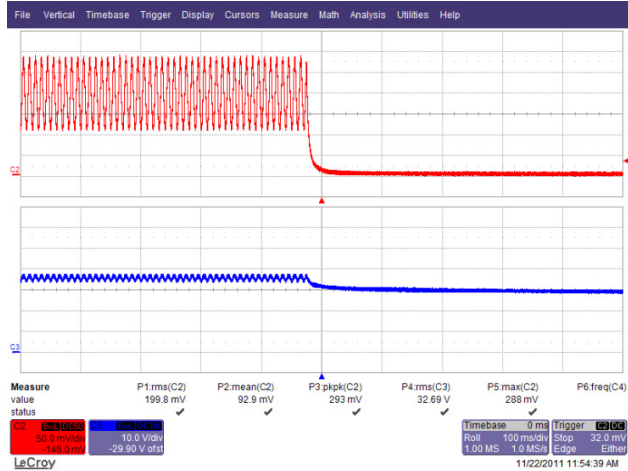

Figure 32 – 265 VAC Output Fall.
 Upper: I_{OUT} , 50 mA / div.
 Lower: V_{OUT} , 10 V, 100 ms / div.



10.4 Input Voltage and Output Current Waveform at Start-up

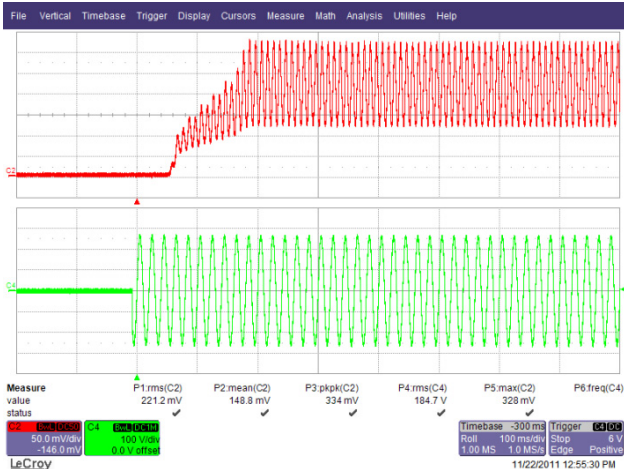

Figure 33 – 185 VAC, 50 Hz.
Upper: I_{OUT} , 50 mA / div.
Lower: V_{IN} , 100 V, 100 ms / div.

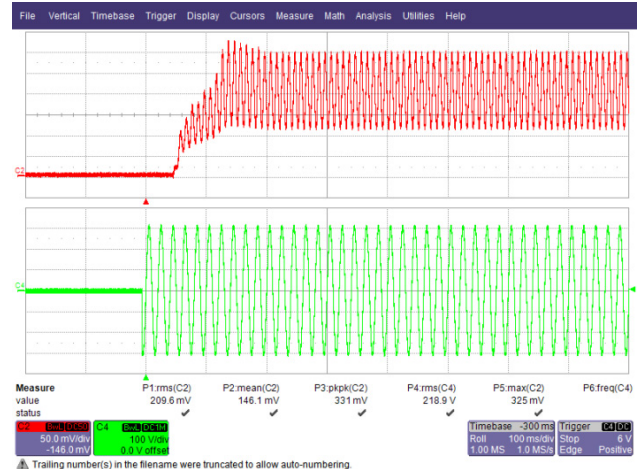

Figure 34 – 220 VAC, 50 Hz.
Upper: I_{OUT} , 50 mA / div.
Lower: V_{IN} , 100 V, 100 ms / div.

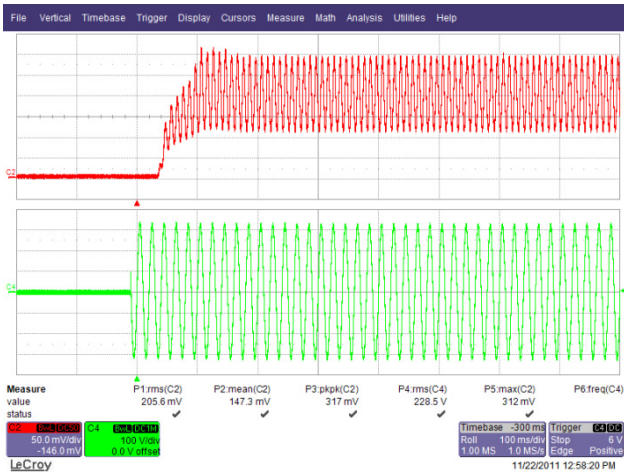

Figure 35 – 230 VAC, 50 Hz.
Upper: I_{OUT} , 50 mA / div.
Lower: V_{IN} , 100 V, 100 ms / div.

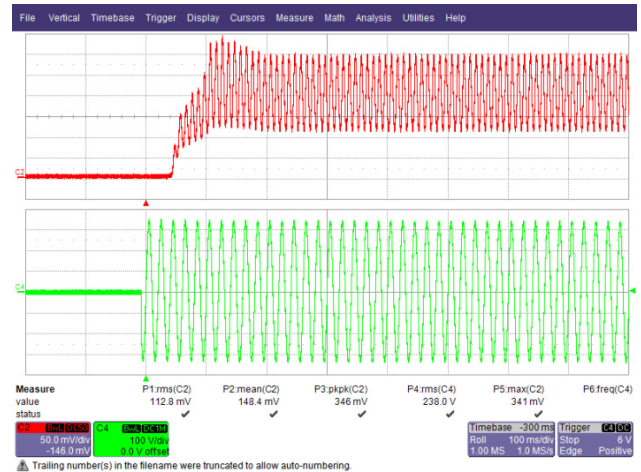

Figure 36 – 240 VAC, 50 Hz.
Upper: I_{OUT} , 50 mA / div.
Lower: V_{IN} , 100 V, 100 ms / div.



10.5 Drain Voltage and Current at Normal Operation

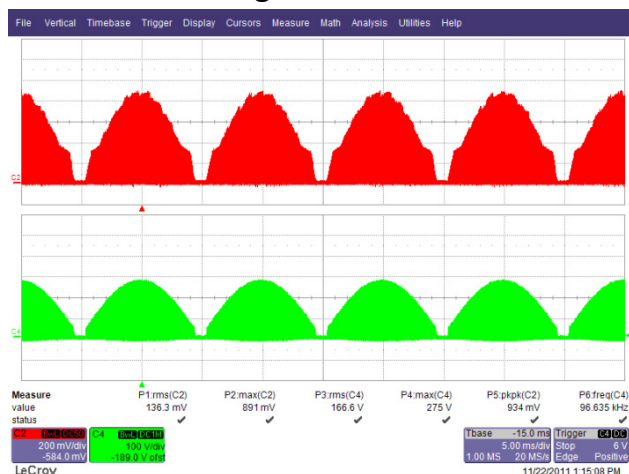

Figure 37 – 185 VAC, 50 Hz.
 Upper: I_{DRAIN} , 200 mA / div.
 Lower: V_{DRAIN} , 100 V, 5 ms / div.



Figure 38 – 185 VAC, 50 Hz.
 Upper: I_{DRAIN} , 200 mA / div.
 Lower: V_{DRAIN} , 100 V, 5 ms / div.

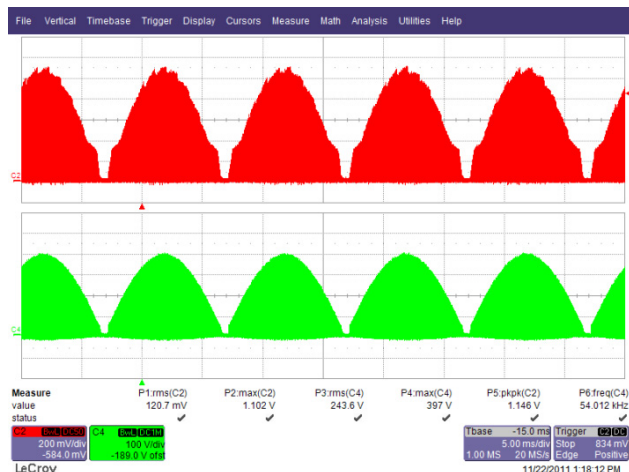

Figure 39 – 265 VAC, 50 Hz.
 Upper: I_{DRAIN} , 200 mA / div.
 Lower: V_{DRAIN} , 100 V, 5 ms / div.



Figure 40 – 265 VAC, 50 Hz.
 Upper: I_{DRAIN} , 200 mA / div.
 Lower: V_{DRAIN} , 100 V, 5 ms / div.



10.6 Start-up Drain Voltage and Current

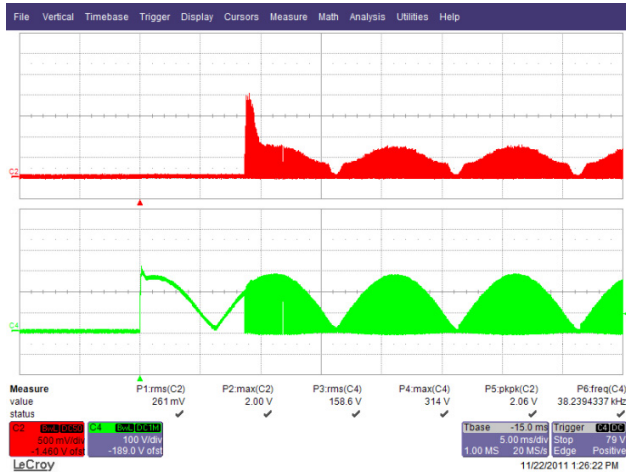

Figure 41 – 185 VAC, 50 Hz.
 Upper: I_{DRAIN}, 500 mA / div.
 Lower: V_{DRAIN}, 100 V, 5 ms / div.

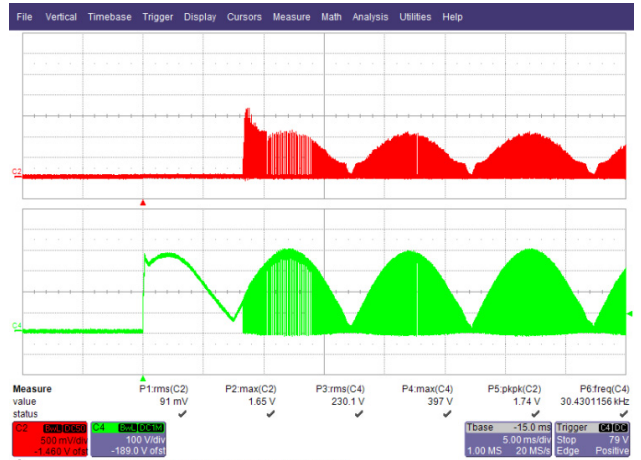

Figure 42 – 265 VAC, 50 Hz.
 Upper: I_{DRAIN}, 500 mA / div.
 Lower: V_{DRAIN}, 100 V, 5 ms / div.

10.7 Output Current and Drain Voltage During Output Short Condition

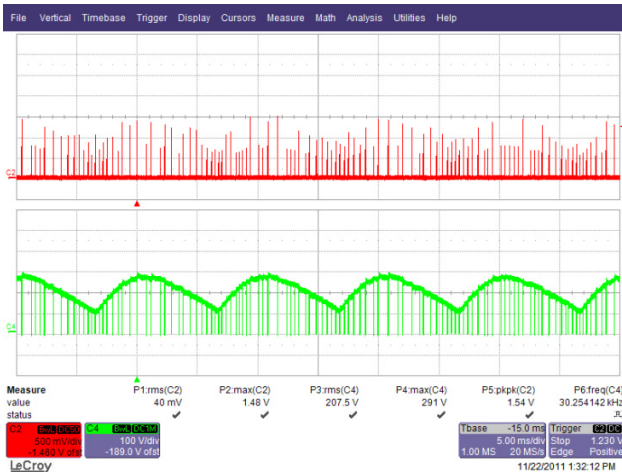

Figure 43 – 185 VAC, 50 Hz Output Short Condition.
 Upper: I_{DRAIN}, 500 mA / div.
 Lower: V_{DRAIN}, 100 V, 5ms / div.

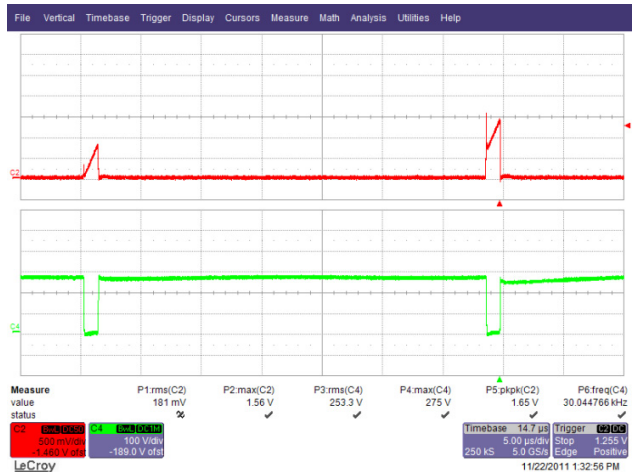

Figure 44 – 185 VAC, 50 Hz Output Short Condition.
 Upper: I_{DRAIN}, 500 mA / div.
 Lower: V_{DRAIN}, 100 V, 5μs / div.



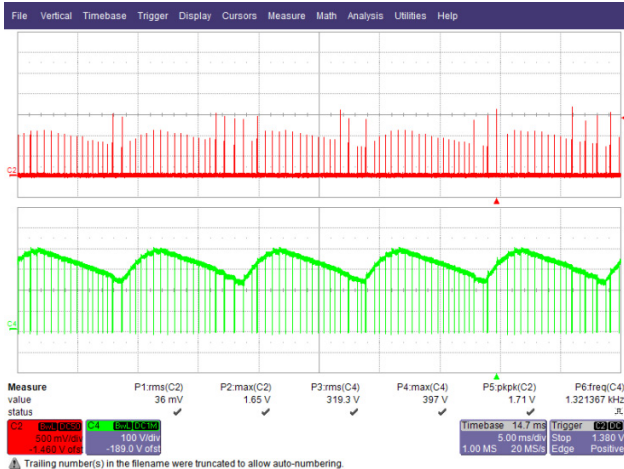

Figure 45 – 265 VAC, 50 Hz Output Short Condition.
 Upper: I_{DRAIN} , 500 mA / div.
 Lower: V_{DRAIN} , 100 V, 5ms / div.

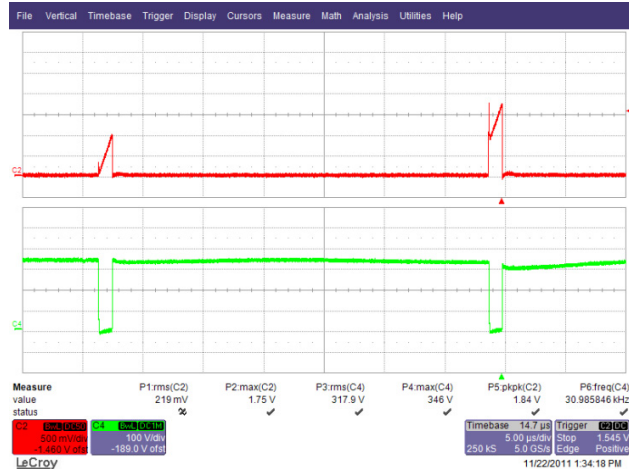

Figure 46 – 265 VAC, 50 Hz Output Short Condition.
 Upper: I_{DRAIN} , 500 mA / div.
 Lower: V_{DRAIN} , 100 V, 5μs / div.

10.8 Open Load Output Voltage

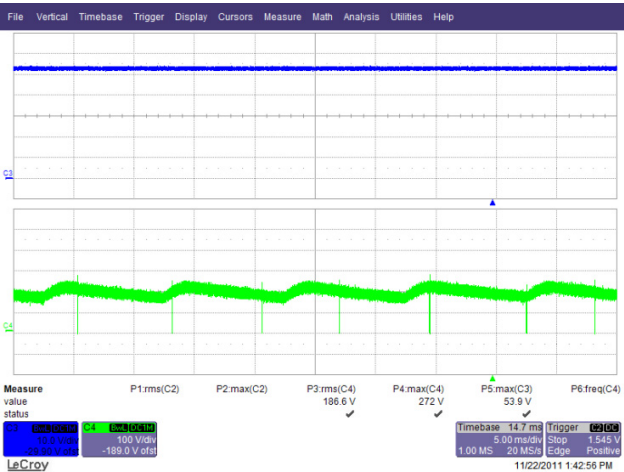

Figure 47 – 185 VAC, 50 Hz Open Load Characteristic.
 Upper: V_{OUT} , 10 V / div.
 Lower: V_{DRAIN} , 100 V / div., 5ms / div.

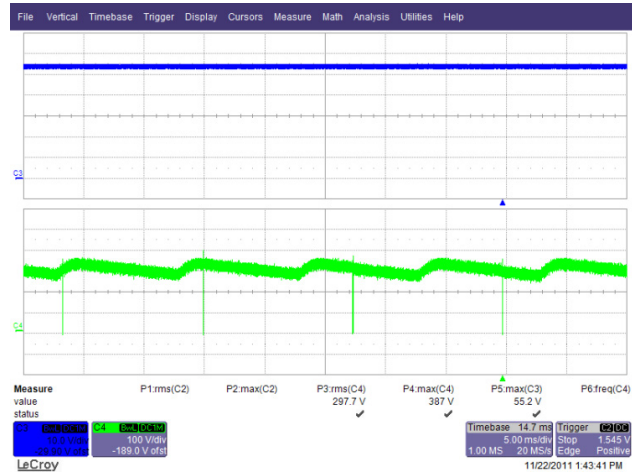

Figure 48 – 265 VAC, 50 Hz Open Load Characteristic.
 Upper: V_{OUT} , 10 V / div.
 Lower: V_{DRAIN} , 100 V / div., 5ms / div.

The 50 V rating of the output cap is exceeded during open load condition. To improve OVP performance, a Zener equivalent to VR1 can be placed across the output to improve clamping.



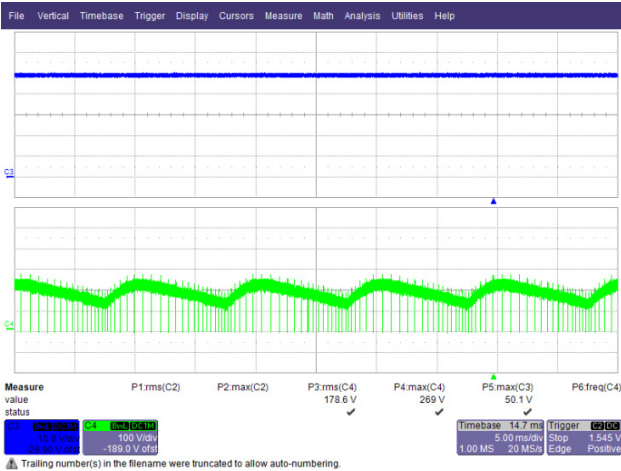

Figure 49 – 185 VAC, 50 Hz Open Load with 47 V Zener Across Output.
 Upper: V_{OUT} , 10 V / div.
 Lower: V_{DRAIN} , 100 V / div., 5ms / div.

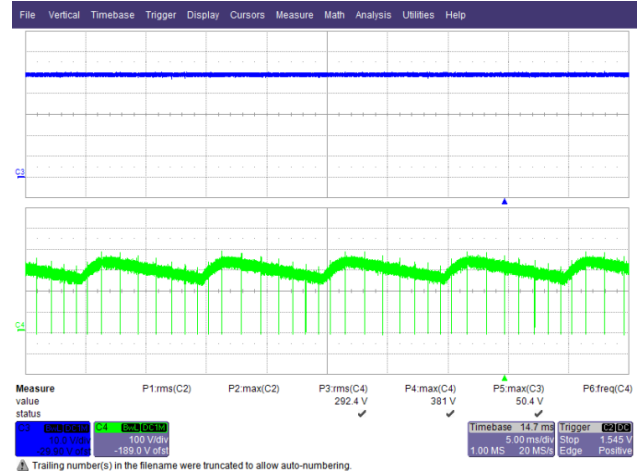

Figure 50 – 265 VAC, 50 Hz Open Load with 47 V Zener Across Output.
 Upper: V_{OUT} , 10 V / div.
 Lower: V_{DRAIN} , 100 V / div., 5ms / div.

10.9 Brown-in and Brown-out Condition

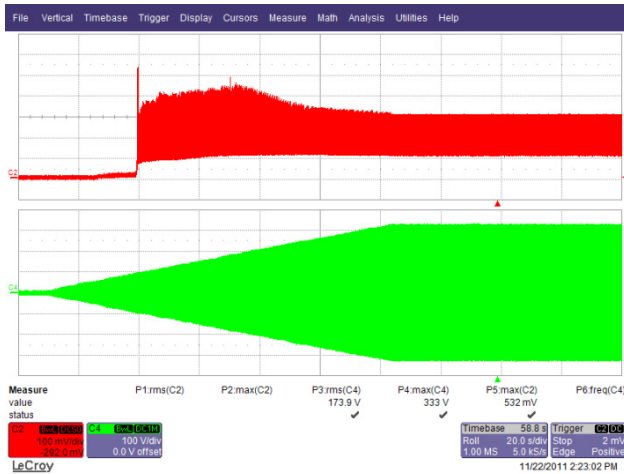

Figure 51 – 0 VAC – 230 VAC, 2 V/ μ s Slew Rate.
 Upper: I_{OUT} , 100 mA / div.
 Lower: V_{INAC} , 100 V, 20 s / div.

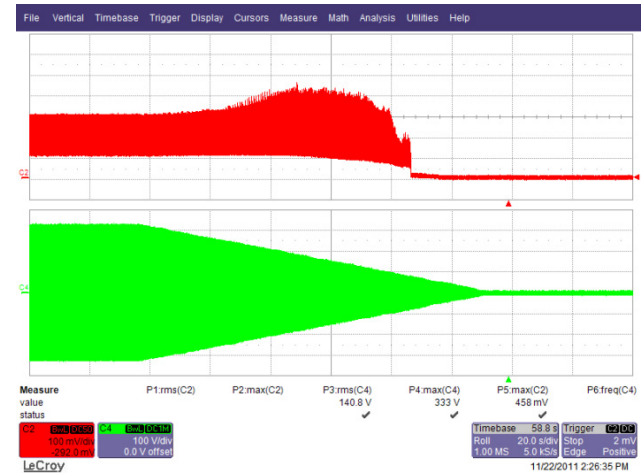

Figure 52 – 230 VAC – 0 VAC, 2 V/ μ s Slew Rate.
 Upper: I_{OUT} , 100 mA / div.
 Lower: V_{INAC} , 100 V, 20 s / div.



11 Conducted EMI

11.1 Test Set-up

The unit was tested using LED load ($\sim 36\text{ V } V_{\text{OUT}}$) with input voltage of 230 VAC, 60 Hz at room temperature.



Figure 53 – EMI Test Set-up With the Unit and LED Load Placed Inside the Cone.



11.2 EMI Test Result

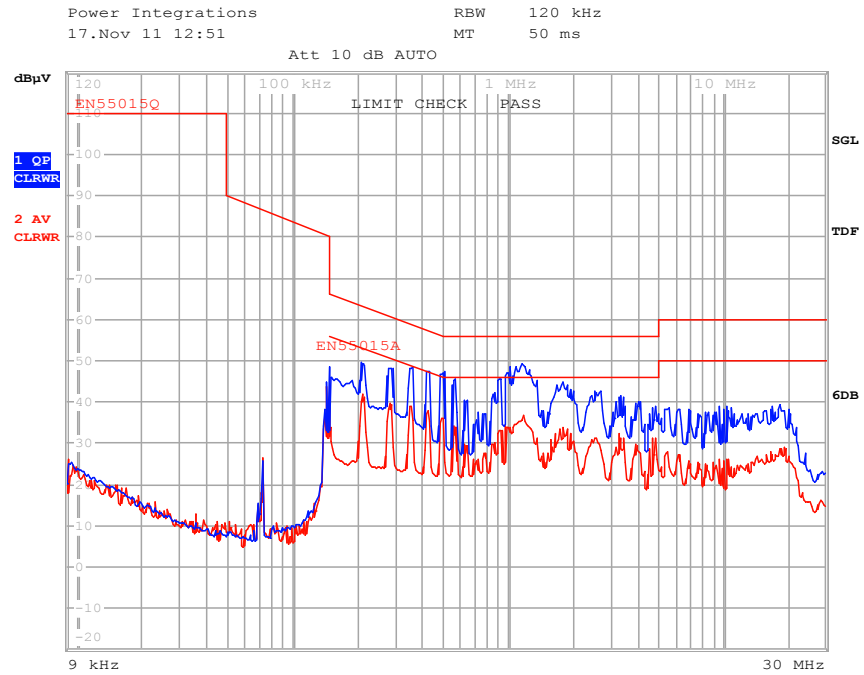

Figure 54 – Conducted EMI, L1 Phase. 36 V / 200 mA Load, 230 VAC, 60 Hz, and EN55015 Limits.

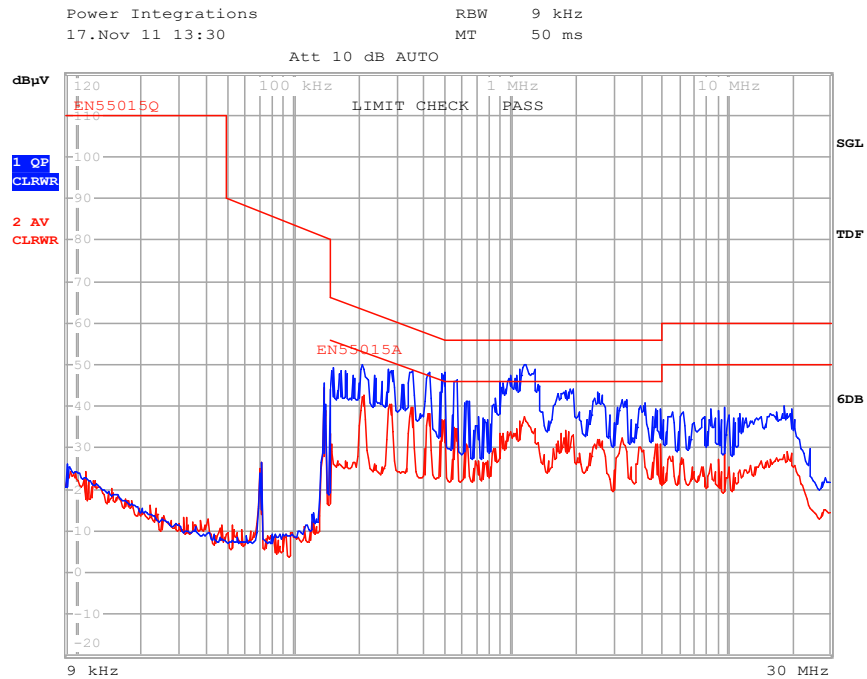

Figure 55 – Conducted EMI, NTL Phase. 36 V / 200 mA Load, 230 VAC, 60 Hz, and EN55015 Limits.



12 Line Surge

12.1 Line Surge Waveform

The power supply was tested for differential 500 V 1.2 / 50 μs surge and for differential 2.5 kV ringing waveform.

12.1.1 500 V 1.2 / 50 μs Surge Test Drain Waveforms Worst Case

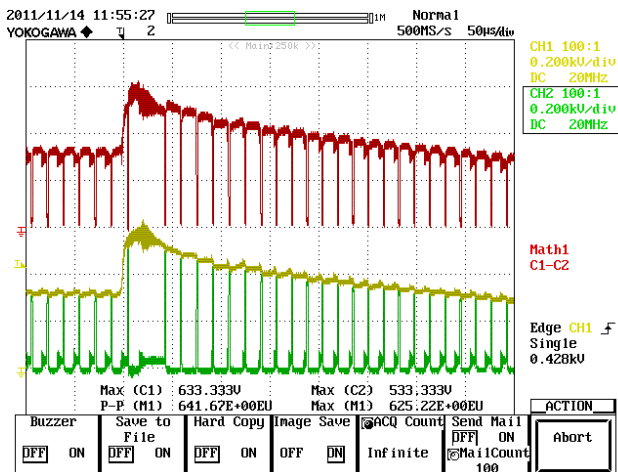

Figure 56 – 230 VAC / 60 Hz, 36 V Load,
Surge +500 V / 90 Degrees.
Upper: $V_{DS} = 642$ PK-PK, 200 V / div.
Middle: V_{DRAIN} , 200 V / div.
Lower: V_{SOURCE} , 200 V / div.

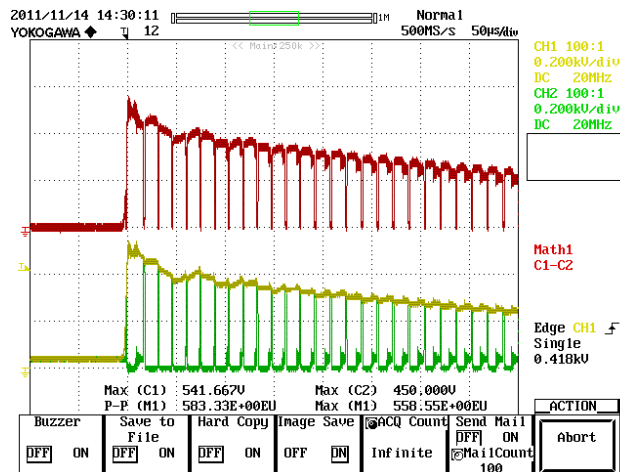

Figure 57 – 230 VAC / 60 Hz, 36 V Load,
Surge +500 V / 0 Degrees.
Upper: $V_{DS} = 583$ PK-PK, 200 V / div.
Middle: V_{DRAIN} , 200 V / div.
Lower : V_{SOURCE} , 200 V / div.

In the above right-side picture, the surge is injected at zero-degrees phase. Before the surge, the bulk cap is uncharged and the controller is not switching. When the surge is injected the bulk cap gets charged and the controller starts to run.

12.1.2 Increasing Differential Sure Withstand to 1 kV

For 1 kV differential surge withstand, due to higher energy vs. 500 V, damper resistors R9 and R13 could potentially open after several strikes. An alternative configuration can be implemented to prevent this. The MOV should be placed before the passive damper resistors R9 and R13 and a safety fuse should be added on the line terminal to protect against failure of the MOV.



12.2 Line Surge Summary

Input voltage was set at 230 VAC / 60 Hz. Output was loaded with 36 V LED string and operation was verified following each surge event.

Differential input line 1.2 / 50 μ s surge testing was completed on one test unit to IEC61000-4-5.

Surge Level (V) 10 strikes / condition	Input Voltage (VAC)	Injection Location	Injection Phase (°)	Test Result (Pass/Fail)
+500	230	L to N	0	Pass
-500	230	L to N	0	Pass
+500	230	L to N	90	Pass
-500	230	L to N	90	Pass

Differential input line ring surge testing was completed on one test unit to IEC61000-4-5.

Surge Level (V) 10 strikes / condition	Input Voltage (VAC)	Injection Location	Injection Phase (°)	Test Result (Pass/Fail)
+2500	230	L to N	0	Pass
-2500	230	L to N	0	Pass
+2500	230	L to N	90	Pass
-2500	230	L to N	90	Pass

Unit passes under all test conditions.



13 Revision History

Date	Author	Revision	Description and Changes	Reviewed
11-Jan-12	VC, CA	1.0	Initial Release	Apps & Mktg



For the latest updates, visit our website: www.powerint.com

Power Integrations reserves the right to make changes to its products at any time to improve reliability or manufacturability. Power Integrations does not assume any liability arising from the use of any device or circuit described herein. POWER INTEGRATIONS MAKES NO WARRANTY HEREIN AND SPECIFICALLY DISCLAIMS ALL WARRANTIES INCLUDING, WITHOUT LIMITATION, THE IMPLIED WARRANTIES OF MERCHANTABILITY, FITNESS FOR A PARTICULAR PURPOSE, AND NON-INFRINGEMENT OF THIRD PARTY RIGHTS.

PATENT INFORMATION

The products and applications illustrated herein (including transformer construction and circuits' external to the products) may be covered by one or more U.S. and foreign patents, or potentially by pending U.S. and foreign patent applications assigned to Power Integrations. A complete list of Power Integrations' patents may be found at www.powerint.com. Power Integrations grants its customers a license under certain patent rights as set forth at <http://www.powerint.com/ip.htm>.

The PI Logo, TOPSwitch, TinySwitch, LinkSwitch, DPA-Switch, PeakSwitch, CAPZero, SENZero, LinkZero, HiperPFS, HiperTFS, HiperLCS, Qspeed, EcoSmart, Clampless, E-Shield, Filterfuse, StackFET, PI Expert and PI FACTS are trademarks of Power Integrations, Inc. Other trademarks are property of their respective companies. ©Copyright 2011 Power Integrations, Inc.

Power Integrations Worldwide Sales Support Locations

WORLD HEADQUARTERS

5245 Hellyer Avenue
San Jose, CA 95138, USA.
Main: +1-408-414-9200
Customer Service:
Phone: +1-408-414-9665
Fax: +1-408-414-9765
e-mail:
usasales@powerint.com

GERMANY

Rueckertstrasse 3
D-80336, Munich
Germany
Phone: +49-89-5527-3911
Fax: +49-89-5527-3920
e-mail:
eurosales@powerint.com

JAPAN

Kosei Dai-3 Building
2-12-11, Shin-Yokohama,
Kohoku-ku, Yokohama-shi,
Kanagawa 222-0033
Japan
Phone: +81-45-471-1021
Fax: +81-45-471-3717
e-mail: japansales@powerint.com

TAIWAN

5F, No. 318, Nei Hu Rd., Sec. 1
Nei Hu District
Taipei 114, Taiwan R.O.C.
Phone: +886-2-2659-4570
Fax: +886-2-2659-4550
e-mail:
taiwansales@powerint.com

CHINA (SHANGHAI)

Rm 1601/1610, Tower 1
Kerry Everbright City
No. 218 Tianmu Road West
Shanghai, P.R.C. 200070
Phone: +86-021-6354-6323
Fax: +86-021-6354-6325
e-mail:
chinasales@powerint.com

INDIA

#1, 14th Main Road
Vasanthanagar
Bangalore-560052
India
Phone: +91-80-4113-8020
Fax: +91-80-4113-8023
e-mail:
indiasales@powerint.com

KOREA

RM 602, 6FL
Korea City Air Terminal B/D, 159-6
Samsung-Dong, Kangnam-Gu,
Seoul, 135-728
Korea
Phone: +82-2-2016-6610
Fax: +82-2-2016-6630
e-mail: koreasales@powerint.com

EUROPE HQ

1st Floor, St. James's House
East Street, Farnham
Surrey GU9 7TJ
United Kingdom
Phone: +44 (0) 1252-730-141
Fax: +44 (0) 1252-727-689
e-mail:
eurosales@powerint.com

CHINA (SHENZHEN)

3rd Floor, Block A, Zhongtuo
International Business Center,
No. 1061, Xiang Mei Road,
FuTian District, ShenZhen,
China, 518040
Phone: +86-755-8379-3243
Fax: +86-755-8379-5828
e-mail:
chinasales@powerint.com

ITALY

Via De Amicis 2
20091 Bresso MI
Italy
Phone: +39-028-928-6000
Fax: +39-028-928-6009
e-mail:
eurosales@powerint.com

SINGAPORE

51 Newton Road,
#19-01/05 Goldhill Plaza
Singapore, 308900
Phone: +65-6358-2160
Fax: +65-6358-2015
e-mail:
singaporesales@powerint.com

APPLICATIONS HOTLINE

World Wide +1-408-414-9660

APPLICATIONS FAX

World Wide +1-408-414-9760

