



Design Example Report

Title	<i>2.4 W Power Supply using LNK520P</i>
Specification	Input: 85 – 265 VAC Output: 5.0 V / 480 mA
Application	Cell Phone Charger
Author	Power Integrations Applications Department
Document Number	DER-75
Date	September 12, 2005
Revision	1.0

Summary and Features

- Low Cost, Low Component Count Design
- High Efficiency (> 70 %) at Full Load
- Accurate Output Voltage Regulation (using Opto-Coupler Feedback)
- Low Standby Consumption (< 250 mW)
- Meets EMI Without Y-capacitor
- Small Low Cost EE13 Transformer

The products and applications illustrated herein (including circuits external to the products and transformer construction) may be covered by one or more U.S. and foreign patents or potentially by pending U.S. and foreign patent applications assigned to Power Integrations. A complete list of Power Integrations' patents may be found at www.powerint.com.

Table Of Contents

1	Introduction.....	3
2	Power Supply Specification.....	4
3	Schematic.....	5
4	Circuit Description	6
4.1	Input EMI Filtering	6
4.2	LinkSwitch Primary.....	6
4.3	Output Rectification.....	6
4.4	Output Feedback.....	6
4.5	No Load Consumption.....	6
5	PCB Layout	7
6	Bill Of Materials	8
	Transformer Specification.....	9
6.1	Electrical Diagram	9
6.2	Electrical Specifications.....	9
6.3	Materials.....	9
6.4	Transformer Build Diagram	10
6.5	Transformer Construction.....	10
7	Transformer Spreadsheets.....	11
8	Performance.....	13
8.1	Efficiency.....	13
8.2	No-Load Input Power	13
8.3	Regulation	14
8.4	Measurement Data.....	15
9	Waveforms	16
9.1	Drain Voltage and Current, Normal Operation	16
9.2	Load Transient Response (75% to 100% Load Step)	17
9.3	Output Ripple Measurements.....	18
9.3.1	Ripple Measurement Technique	18
9.3.2	Measurement Results	19
10	Conducted EMI	20
11	Revision History.....	22

Important Notes:

Although this board is designed to satisfy safety isolation requirements, the engineering prototype has not been agency approved. Therefore, all testing should be performed using an isolated source to provide power to the prototype board.

Design Reports contain a power supply design specification, schematic, bill of materials, and transformer documentation. Performance data and typical operation characteristics are included. Typically only a single prototype has been built.



1 Introduction

This document is an engineering prototype report describing a cell phone power supply utilizing a LNK520P. This power supply is intended as a general-purpose evaluation platform for this *LinkSwitch* device.

The document contains the power supply specification, schematic, bill of materials, transformer documentation, printed circuit layout, and performance data.

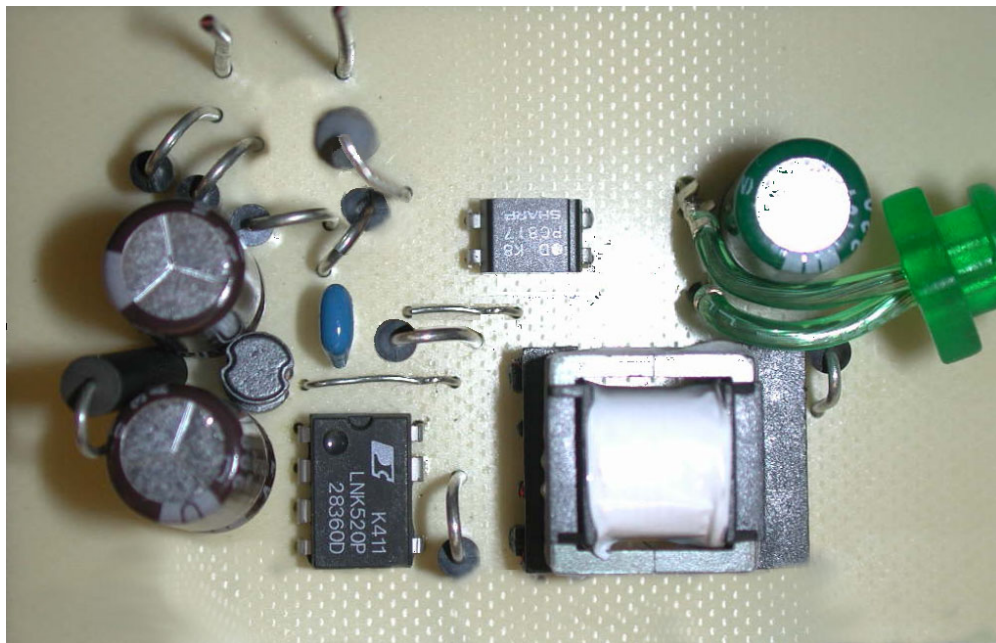
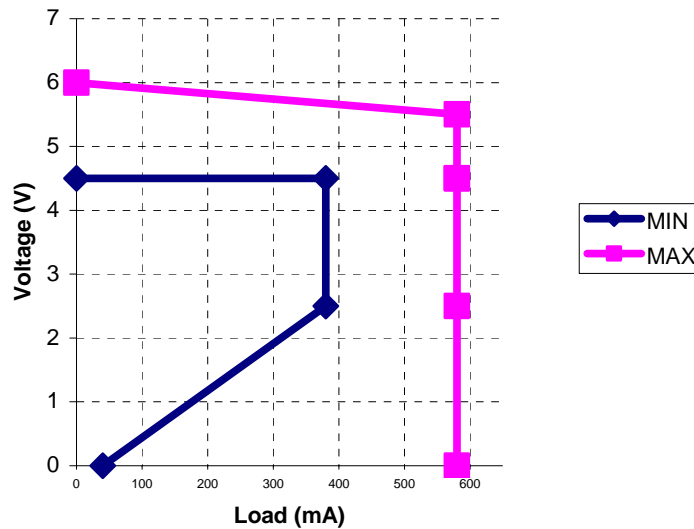

Figure 1 – Populated Circuit Board Photograph

2 Power Supply Specification

Description	Symbol	Min	Typ	Max	Units	Comment
Input						
Voltage	V_{IN}	85		265	VAC	2 Wire – no P.E.
Frequency	f_{LINE}	47	50/60	64	Hz	
No-load Input Power (230 VAC)				0.3	W	
Output						
Output Voltage 1	V_{OUT1}	5.5	5.0	4.5	V	± 5% 20 MHz bandwidth ± 25%
Output Ripple Voltage 1	$V_{RIPPLE1}$				mV	
Output Current 1	I_{OUT1}	380	480	580	mA	
Total Output Power						
Continuous Output Power	P_{OUT}		2.4		W	
Peak Output Power	P_{OUT_PEAK}				W	
Efficiency	η	70			%	Measured at P_{OUT} (43 W), 25 °C
Environmental						
Conducted EMI		Meets CISPR22B / EN55022B				1.2/50 μ s surge, IEC 1000-4-5, Series Impedance: Differential Mode: 2 Ω Common Mode: 12 Ω
Safety		Designed to meet IEC950, UL1950 Class II				
Surge		2			kV	
Surge		2			kV	100 kHz ring wave, 500 A short circuit current, differential and common mode
Ambient Temperature	T_{AMB}	0		50	°C	Free convection, sea level

Regulation Specification



3 Schematic

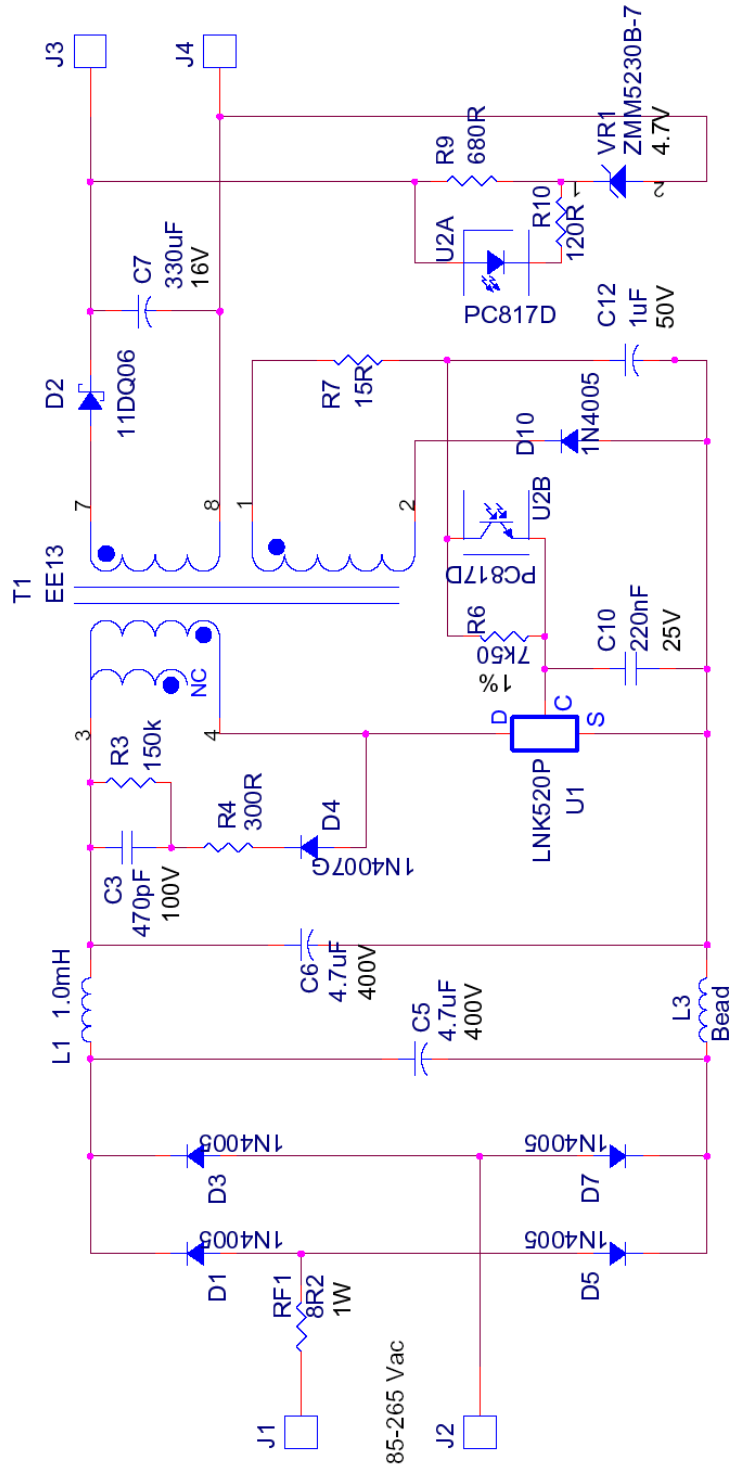

Figure 2 – Schematic



4 Circuit Description

4.1 Input EMI Filtering

Resistor RF1 acts as a fuse for the entire power supply and also limits different surge. Diodes D1, D3, D5, D7 and Capacitors C5, C6 rectify and filter the input waveform to produce a high voltage DC-bus. Inductors L1 and L3 work in conjunction with C5 and C6 to filter and attenuate conducted EMI.

4.2 LinkSwitch Primary

Diode D10 and capacitor C12 rectify and filter the bias voltage. The diode is in a low-side configuration to allow the bias-winding to act as a primary cancellation winding.

Components C3, R3, R4, and D4 form an RCD clamp to capture the leakage spike at Drain turn-off. A slow diode (D4) is used to allow recovery of some of this leakage inductance energy. The remainder is captured in C3 and dissipated in R3.

4.3 Output Rectification

Output diode D2 and capacitor C7 rectify and filter the output voltage.

4.4 Output Feedback

Resistor R9 is used to bias the Zener reference (VR1), adjusting this resistor will adjust the output voltage. Resistor R10 is used to control the opto-coupler current, and depending on the value can also change the output voltage set-point. The opto-coupler U2 transfers the feedback signal across the isolation barrier to the primary side of the supply. Resistor R6 set's the maximum power point before the supply transitions into constant current mode.

4.5 No Load Consumption

No-load consumption is affected by the choice of bias winding components. Use of a slow diode (1N4005GP) makes no-load consumption worse (by about 50mW at low-line), but gives the best CC regulation. Use of a fast diode D6 (such as 1N914) on the bias winding dramatically improves no-load consumption. However use of a fast diode also makes the constant-current (CC) regulation significantly non-linear. The absence of an R-C snubber on the bias-winding, slightly improves the no-load consumption (10mW at low-line). Also the choice of Zener current setting resistor R9 affects the no-load consumption (again by approx 10mW at low-line). The value of resistor R7 has no effect on the no-load consumption. The set-point of the output voltage has a significant effect on the no-load consumption (high output voltage, higher no-load consumption) – e.g. going from $V_{out} = 5.44\text{ V}$ to $V_{out} = 6.5\text{ V}$, the no-load consumption increased by 50mW.



5 PCB Layout

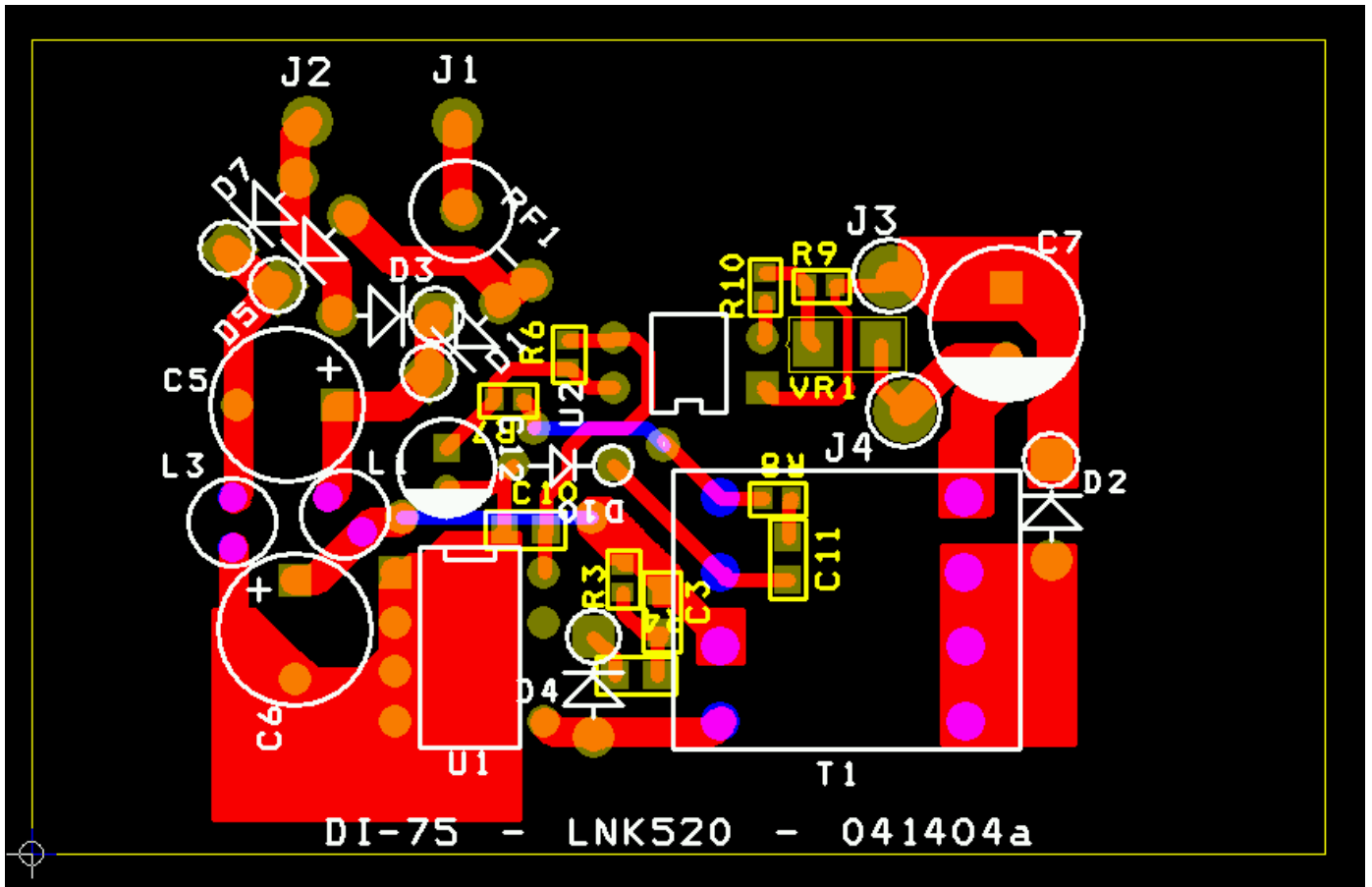

Figure 3 – Printed Circuit Layout



6 Bill Of Materials

Item	Quantity	Part Reference	Description	Part Number	Mfg Part Number
1	1	C3	CAP 470pF 100V CERM CHIP X7R 0805 SMD	20-00205-00	ECU-V1H471KBN
2	2	C5 C6	Cap,Al Elect,4.7uF,400V,8mmX11.5mm,Sam Young	20-00434-00	SHD400WV 4.7uF
3	1	C7	Elect,330uF,16V,8mmX11.5mm,KZE Series,NIPPON CHEMI-CON	20-00014-00	KZE16VB331MH 11LL
4	1	C10	CAP 0.22uF 25V CERM CHIP X7R 0805 SMD	20-00237-00	ECJ-2YB1E224K
5	1	C12	Cap,Cer, 1.0 uF, 50V, 10%	20-00308-00	ECU-S1H105KBB
6	5	D7 D10	Rectifier GPP 600V 1A DO-41	15-00089-00	1N4005-T
7	1	D2	Diode Schottky 60V 1.1A DO-41	15-00153-00	11DQ06
8	1	D4	Rectifier GPP 1000V 1A DO-41	TMP-59	1N4007GDICT
10	2	J1 J2	Terminal,1Pin,22AWG	35-00008-00	
11	2	J3 J4	Terminal,1Pin,18AWG	35-00007-00	
12	2	L1	CHOKE,1mH,SBCP_47HY102B,TOKIN	30-00018-00	SBCP_47HY102 B
12	2	L3	CHOKE,FERRITE BEAD		
13	1	R3	Res,150K 1/16W 5% 0603 SMD	05-01740-00	ERJ-3GEYJ154V
14	1	R4	Res,300 1/10W 5% 0805 SMD	05-01506-00	ERJ-6GEYJ301V
15	1	R6	Res,7.50K 1/16W 1% 0603 SMD	05-01162-00	ERJ-3EKF7501V
16	1	R7	Res,15 1/16W 5% 0603 SMD	05-01644-00	ERJ-3GEYJ150V
17	1	R9	Res,680 1/16W 5% 0603 SMD	05-01684-00	ERJ-3GEYJ681V
18	1	R10	Res,120 1/16W 5% 0603 SMD	05-01666-00	ERJ-3GEYJ121V
19	1	RF1	Res, 8.2 ,1W, 5%, Metal Film	05-02802-00	RSF200JB-0R8.2
20	1	T1	BEE16_H_LOPROFILE_10P IC,LNK 520P,CV or CV/CC	25-00061-00	
21	1	U1	SWITCHER,PLAS,DIP-8B IC,PC817D,PHOTOCOUPLER TRAN	TMP-111	LNK520P
22	1	U2	OUT 4-DIP	45-00008-00	PC817D
23	1	VR1	DIODE ZENER 4.7V 500MW MINIMELF	15-00188-00	ZMM5230B-7



Transformer Specification

6.1 Electrical Diagram

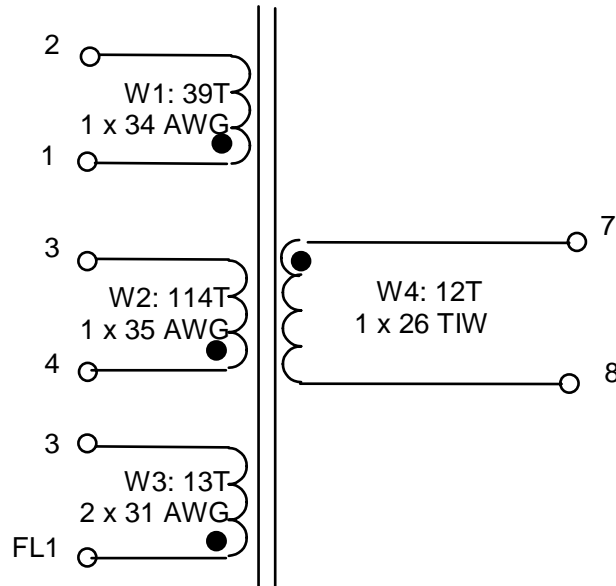

Figure 4 – Transformer Electrical Diagram

6.2 Electrical Specifications

Electrical Strength	1 second, 60 Hz, from Pins 2-1,3-4 to Pins 6-5	3000 VAC
Primary Inductance	Pins 4-3, all other windings open, measured at 100 kHz, 0.4 VRMS	2390 μ H, -0/+20%
Resonant Frequency	Pins 4-3, all other windings open	300 kHz (Min.)
Primary Leakage Inductance	Pins 4-3 with Pins 7-8 shorted, measured at 100 kHz, 0.4 VRMS	100 μ H (Max.)

6.3 Materials

Item	Description
[1]	Core: TDK PC40 EE13, AL = 185 nH/T ²
[2]	Bobbin: EE13 Horizontal
[3a]	Magnet Wire: 34 AWG
[3b]	Magnet Wire: 35 AWG
[3c]	Magnet Wire: 31 AWG
[3d]	Triple Insulated Wire: 26 AWG (TIW)
[4a]	Tape
[6]	Varnish



6.4 Transformer Build Diagram

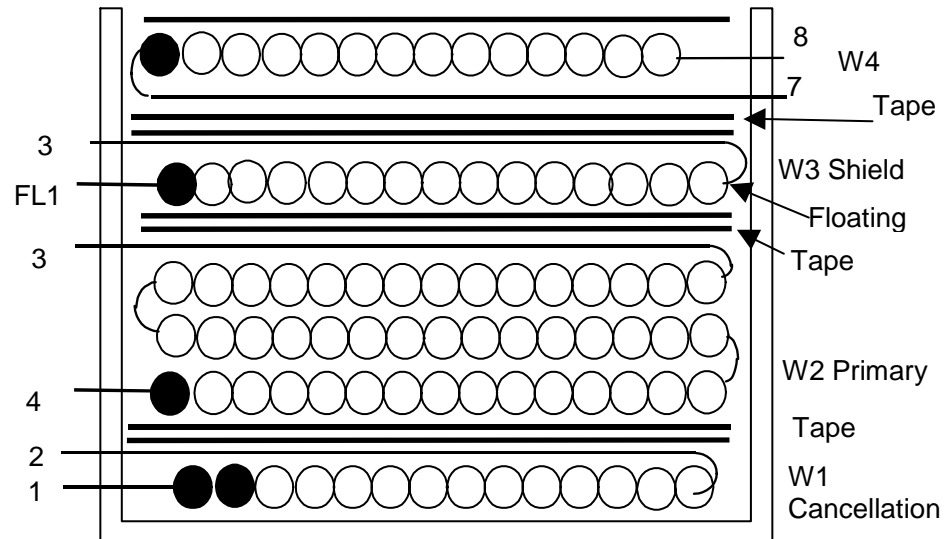

Figure 5 – Transformer Build Diagram.

6.5 Transformer Construction

Shield 1	Start at Pin 1. Wind 39 turns of item [3a] in approximately 1 layer. Finish at Pin 2.
Basic Insulation	Use two layers of item [6] for basic insulation.
Primary	Start at Pin 4. Wind 114 turns of item [3b] in approximately 3 layers. After 1 st layer insert one layer of tape. Complete 2 nd layer insert one layer of tape. Complete 3 rd layer. Finish at Pin 3.
Basic Insulation	Use two layers of item [6] for basic insulation.
Shield 2	Temporary start at Pin 2. Wind 13 turns of bifilar item [3c]. Spread turns evenly across bobbin. Finish at Pin 3. (Disconnect from pin 2 and leave floating (FL1) in the stack.)
Basic Insulation	Use one layer of item [7] for basic insulation.
Secondary Winding	Temporary start at pin 2. Wind 12 turns of item [3d] in 1 layer. Finish on Pin 8. Move connection from pin 2 to pin 7.
Outer Wrap	Wrap windings with 3 layers of tape [item [4a].
Final Assembly	Assemble and secure core halves. Varnish dip (item [6]).

7 Transformer Spreadsheets

LinkSwitch (LNK52X) 030404; Rev.1.7; Copyright Power Integrations 2004	INPUT	INFO	OUTPUT	UNIT	LinkSwitch (LNK52X) 030404 Rev.1.7; Copyright Power Integrations 2004
ENTER APPLICATION VARIABLES					
VACMIN	85			Volts	Minimum AC Input Voltage
VACMAX	265			Volts	Maximum AC Input Voltage
fL	50			Hertz	AC Mains Frequency
VO	5			Volts	Output Voltage
IO	0.48			Amps	Continuous Nominal Output current
VBIAS	20				Bias voltage (recommended default 20V, minimum 16V)
tC	3			msec	Bridge Rectifier Conduction Time Estimate
CIN	9.4			uFarads	Input Filter Capacitor
ESTIMATED LOSSES					
PCORE			146.3907	mW	Estimated Core Losses at peak Flux Density (BP)
RCLAMP			200	Kohm	Primary clamp resistor (recommended default clamp resistor, RCLAMP)
ESR			0.15	Ohms	Output Capacitor ESR
RSEC			0.2	Ohms	Estimated Resistance of transformer secondary winding.
DC INPUT VOLTAGE PARAMETERS					
VMIN			97.50129	Volts	Minimum DC Input Voltage
VMAX			374.7666	Volts	Maximum DC Input Voltage
ENTER OUTPUT CABLE PARAMETERS					
RCABLE			0.3	Ohms	Resistance of total length of cable from power supply terminals to load and back.
VCABLE			0.144	Volts	Drop along cable connecting power supply to load
ENTER LinkSwitch & OUTPUT DIODE VARIABLES					
LinkSwitch	LNK520			Universal	115 Doubled/230
			Power	5.5	3.5
I ² f			2710	A ² Hz	I ² f (typical) co-efficient for LinkSwitch
VOR	54		54	Volts	Reflected Output Voltage (40<VOR<80 recommended)
VLEAK			2	Volts	Error in Feedback voltage as a result of leakage inductance in primary circuit.
VD	0.56		0.56	Volts	Output Winding Diode Forward Voltage Drop (0.5~0.7V for schottky and 0.7~1.0V for PN diode)
VR			60	Volts	Rated Peak Rep Reverse Voltage of secondary diode
ID	1.1			Amps	Rated Average Forward current for secondary diode
DISCONTINUOUS MODE CHECK					
KDP			1.531793		Ensure KDP > 1.15 for discontinuous mode operation.
TON			6.587284	us	Linkswitch conduction time
TDON			11.24319	us	Secondary Diode conduction time
VOLTAGE STRESS ON LinkSWITCH AND OUTPUT DIODE					
VDRAIN			508.1666	Volts	Maximum Drain Voltage Estimate (Includes Effect of Leakage Inductance)
PIVS			44.58646	Volts	Output Rectifier Maximum Reverse Voltage
CURRENT WAVEFORM SHAPE PARAMETERS					
DMAX			0.276666		Maximum Operating Duty Cycle
Iavg			0.035137	Amps	Average Primary Current
IRMS			0.077135	Amps	Primary RMS Current



ENTER TRANSFORMER CORE/CONSTRUCTION VARIABLES					
Core Type	EE13				
Core		PC40EE13-Z			
Bobbin		BE-13			
AE			0.171	cm ²	Core Effective Cross Sectional Area
LE			3.02	cm	Core Effective Path Length
AL			1130	nH/T ²	Ungapped Core Effective Inductance
VE			517	mm ³	Effective Core Volume
BW			7.4	mm	Bobbin Physical Winding Width
KCORE			551.5424	kW/m ³	Core losses per unit volume
T(n)	0.9		0.9		Estimated transformer efficiency. T(n)=(PSCU+PCORE/2)/POEFF. Re-iterate with n = 0.9147
M			0	mm	Safety Margin Width
NS	12				Number of Secondary Turns
TRANSFORMER PRIMARY DESIGN PARAMETERS					
dLP			1.003		Constant to account for reduction of inductance at higher flux densities. (0.999<dLP<1.05)
LP			2390.284	uHenries	Primary Inductance
L	3		3		Number of Primary Layers
LBIAS	1		1		Number of Bias winding Layers
NP			113.6045		Primary Winding Number of Turns
NB			36.28176		
ALG			185.2075	nH/T ²	Gapped Core Effective Inductance
BP			3445.212	Gauss	Peak Flux Density (BP<3700)
LG			0.097008	mm	Core Gap Length for primary inductance
OD			0.195415	mm	Maximum Primary Wire Diameter including insulation to give specified number of layers.
DIA			0.154132	mm	Bare conductor diameter
AWG			35	AWG	Primary Wire Gauge (Rounded to next smaller standard AWG value)
CMA			414.8576	Cmils/Amp	Primary Winding Current Capacity (200 < CMA < 500)
AWG_BIAS			32	AWG	
TRANSFORMER SECONDARY DESIGN PARAMETERS					
ISP			2.404628	Amps	Peak Secondary Current
ISRMS			0.954018	Amps	Secondary RMS Current
IRIPPLE			0.82447	Amps	Output Capacitor RMS Ripple Current
AWGS			30	AWG	Secondary Wire Gauge (Rounded up to next larger standard AWG value)
DIAS			0.256342	mm	Secondary Minimum Bare Conductor Diameter
ODS			0.616667	mm	Secondary Maximum Insulated Wire Outside Diameter
INSS			0.180162	mm	Maximum Secondary Insulation Wall Thickness
VSEC			0.096	Volts	Voltage Drop across secondary winding
FEEDBACK CIRCUIT COMPONENTS					
RFB			7.065217	k-Ohms	Feedback resistor
PRFB			37.375	mW	Losses in the Feedback resistor
ESTIMATED LOSSES IN POWER SUPPLY AND EFFICIENCY, LOW LINE					
PCABLE			69.12	mW	Power loss in Output Cable
PSCU			182.0302	mW	Transformer Secondary Copper Losses
PDIODE			268.8	mW	Output Diode conduction loss
PCAP			136.5226	mW	
PBIAS			50.6	mW	Power Loss in Feedback circuit
PCONDUCTION			249.8913	mW	Conduction Losses in LinkSwitch calculated at 100C
PCLAMP			14.58	mW	Primary clamp losses
PCORE			146.3907	mW	Core Losses at peak Flux Density
PBRIDGE			32.93465	mW	Primary bridge rectifier losses
EFFICIENCY ESTIMATE			67.58908	%	Estimated Power Supply Efficiency
ADDITIONAL OUTPUT					
VX				Volts	Auxiliary Output Voltage
VDX				Volts	Auxiliary Diode Forward Voltage Drop
NX			0		Auxiliary Number of Turns
PIVX			0	Volts	Auxiliary Rectifier Maximum Peak Inverse Voltage



8 Performance

8.1 Efficiency

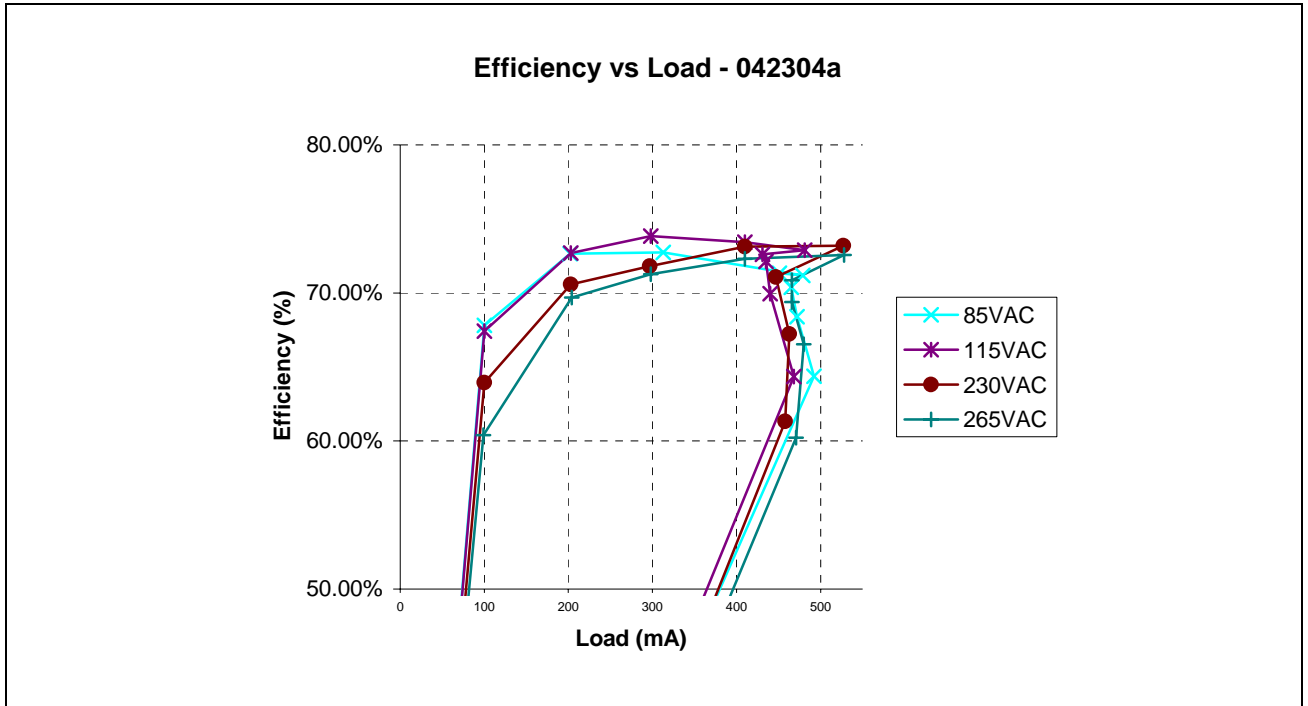

Figure 6 – Efficiency vs. Input Voltage, Room Temperature, 60 Hz.

8.2 No-Load Input Power

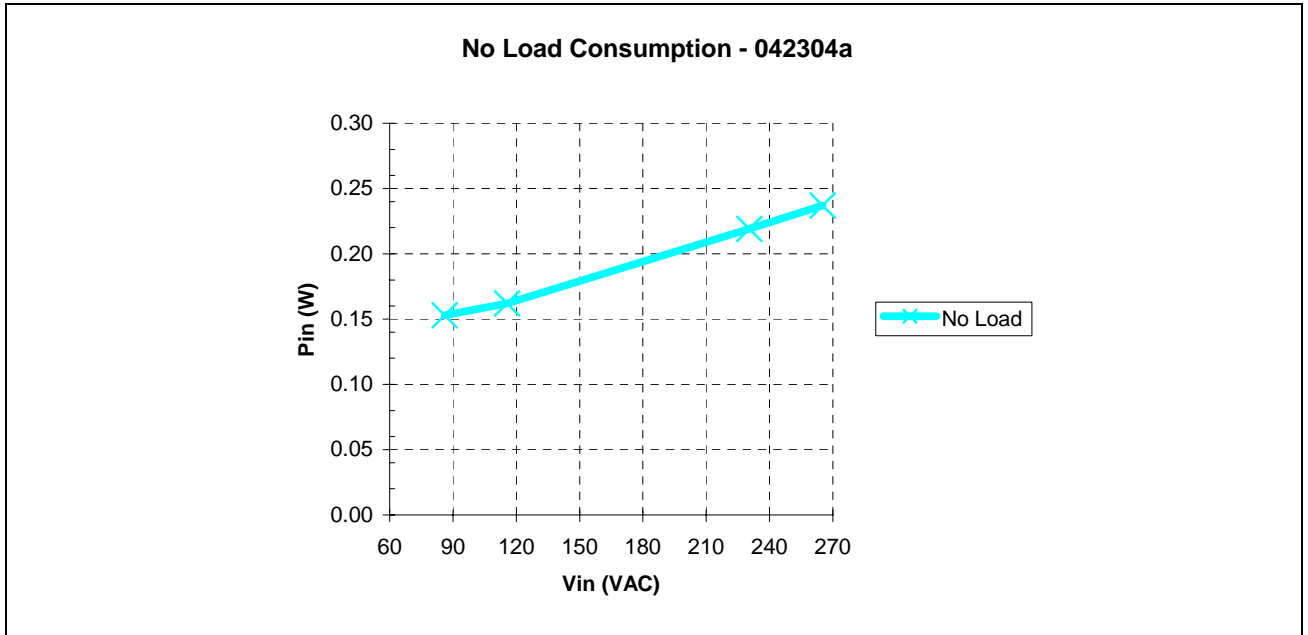

Figure 7 – Zero Load Input Power vs. Input Line Voltage, Room Temperature, 60 Hz.



8.3 Regulation

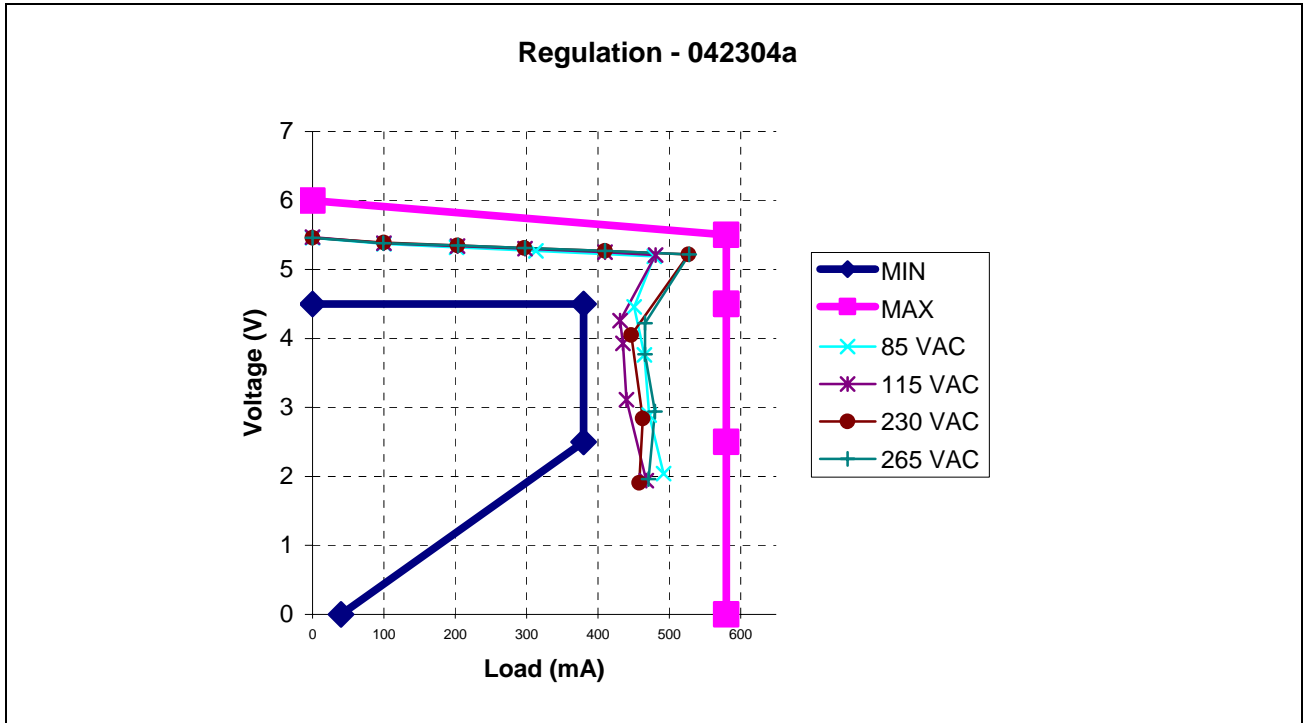

Figure 8 – Line and Load Regulation, Room Temperature



8.4 Measurement Data

Vin	Pin	Vout	Iout	Pout	Eff
86.05	0.153	5.46	0	0	0
86.07	0.792	5.37	100	0.537	0.67803
85.95	1.479	5.32	202	1.07464	0.726599
85.77	2.268	5.27	313	1.64951	0.727297
85.65	3.492	5.19	479	2.48601	0.711916
85.85	2.82	4.46	451	2.01146	0.713284
85.77	2.484	3.76	465	1.7484	0.703865
85.93	1.995	2.891	472	1.364552	0.683986
86.01	1.56	2.041	492	1.004172	0.6437
86.19	0.138	0.203	64	0.012992	0.094145
86.13	0.132	0.005	75	0.000375	0.002841
115.67	0.162	5.47	0	0	0
115.71	0.798	5.38	100	0.538	0.674185
115.71	1.491	5.34	203	1.08402	0.727042
115.41	2.139	5.3	298	1.5794	0.738382
115.38	2.931	5.25	410	2.1525	0.734391
115.39	3.438	5.21	481	2.50601	0.728915
115.59	2.529	4.26	431	1.83606	0.726002
115.39	2.37	3.93	435	1.70955	0.721329
115.59	1.959	3.114	440	1.37016	0.699418
115.81	1.41	1.939	468	0.907452	0.643583
115.71	0.162	0.209	66	0.013794	0.085148
115.67	0.156	0.006	73	0.000438	0.002808
230.43	0.219	5.46	0	0	0
230.47	0.843	5.39	100	0.539	0.639383
230.66	1.539	5.35	203	1.08605	0.705686
230.56	2.196	5.31	297	1.57707	0.718156
229.95	2.955	5.27	410	2.1607	0.731201
230.33	3.759	5.22	527	2.75094	0.731828
230.21	2.547	4.05	447	1.81035	0.710777
230.35	1.956	2.84	463	1.31492	0.672249
230.49	1.425	1.908	458	0.873864	0.613238
230.35	0.246	0.173	54	0.009342	0.037976
230.44	0.243	0.005	65	0.000325	0.001337
265.2	0.237	5.46	0	0	0
265.62	0.882	5.38	99	0.53262	0.603878
265.83	1.566	5.35	204	1.0914	0.696935
265.41	2.22	5.31	298	1.58238	0.712784
265.17	2.988	5.27	410	2.1607	0.723126
265.9	3.798	5.22	528	2.75616	0.725687
265.65	2.775	4.22	466	1.96652	0.708656
265.33	2.532	3.77	466	1.75682	0.693847
265.38	2.121	2.94	480	1.4112	0.665347
266.04	1.533	1.96	471	0.92316	0.602192
265.74	0.285	0.181	55	0.009955	0.03493
265.48	0.288	0.006	75	0.00045	0.001563



9 Waveforms

9.1 Drain Voltage and Current, Normal Operation

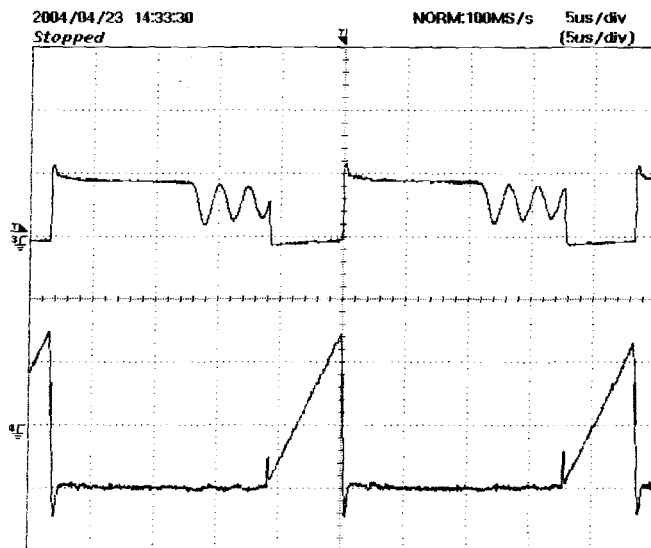

Figure 9 – 85 VAC, Full Load (5.13 V/ 484 mA)
Upper: V_{DRAIN} , 200 V / div,
Lower: I_{DRAIN} , 0.1 A , 5 μ s / div

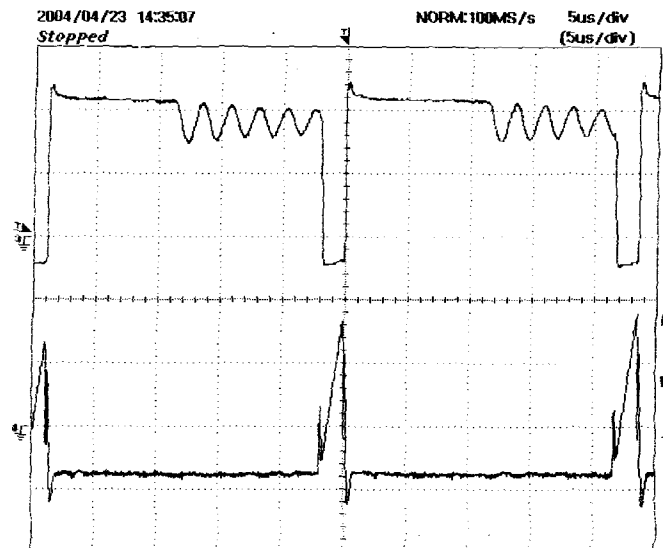

Figure 10 – 265 VAC, Full Load (5.19 V/ 490 mA)
Upper: V_{DRAIN} , 200 V / div,
Lower: I_{DRAIN} , 0.1 A , 5 μ s / div



9.2 Load Transient Response (75% to 100% Load Step)

In the figures shown below, no signal averaging was used. The oscilloscope was triggered using the load current step as a trigger source.

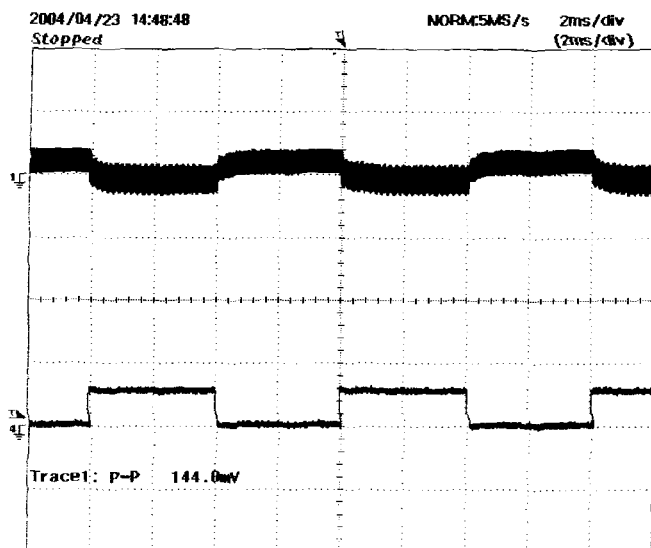

Figure 11 – Transient Response, 115 VAC, 75-100-75% Load Step.
Top: Output Voltage, 200 mV/div.
Bottom: Load Current
200 mA, 2ms / div.

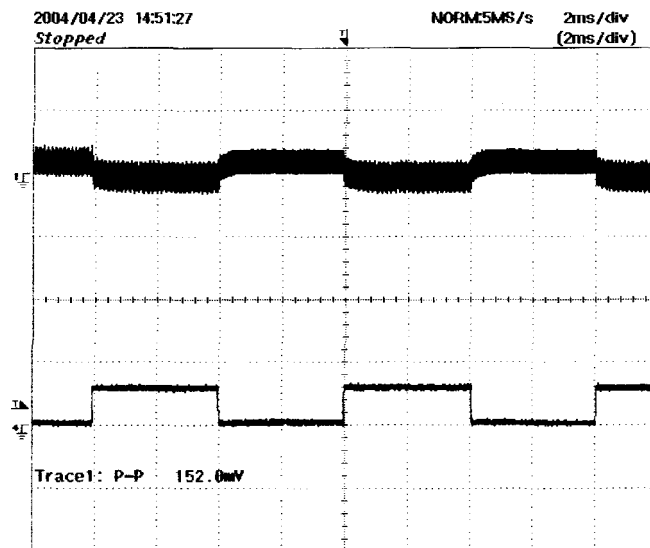

Figure 12 – Transient Response, 230 VAC, 75-100-75% Load Step.
Top: Output Voltage, 200 mV/div.
Bottom: Load Current
200 mA, 2ms / div.



9.3 Output Ripple Measurements

9.3.1 Ripple Measurement Technique

For DC output ripple measurements, a modified oscilloscope test probe must be utilized in order to reduce spurious signals due to pickup. Details of the probe modification are provided in Figure 13 and Figure 14.

The 5125BA probe adapter is affixed with two capacitors tied in parallel across the probe tip. The capacitors include one (1) 0.1 $\mu\text{F}/50\text{ V}$ ceramic type and one (1) 1.0 $\mu\text{F}/50\text{ V}$ aluminum electrolytic. **The aluminum electrolytic type capacitor is polarized, so proper polarity across DC outputs must be maintained (see below).**

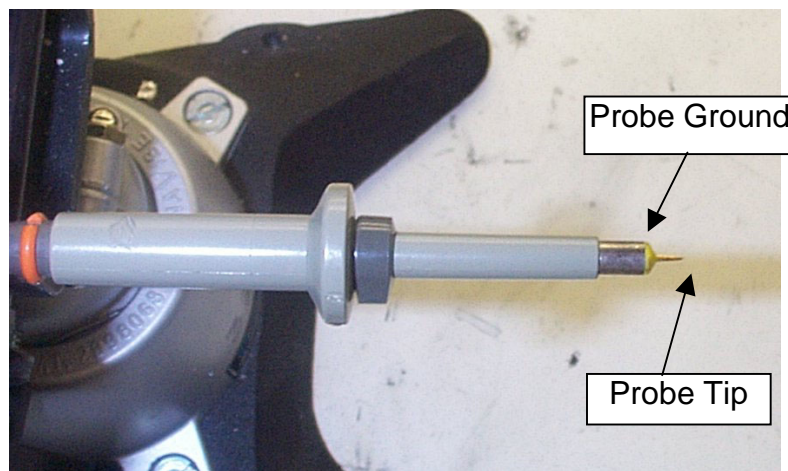

Figure 13 – Oscilloscope Probe Prepared for Ripple Measurement. (End Cap and Ground Lead Removed)

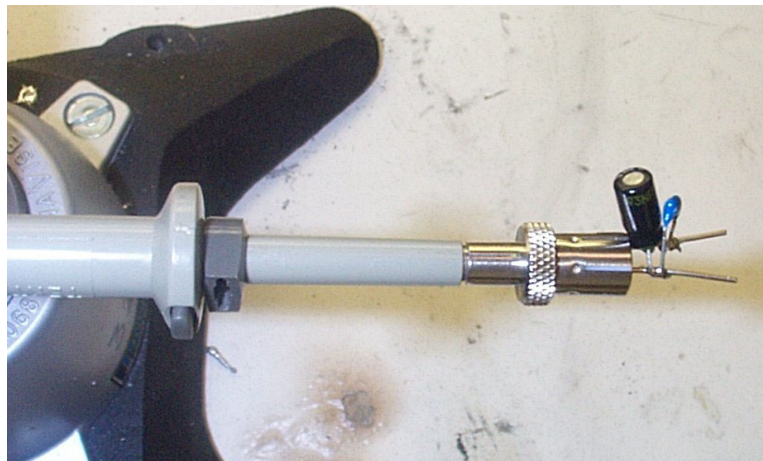

Figure 14 – Oscilloscope Probe with Probe Master 5125BA BNC Adapter. (Modified with wires for probe ground for ripple measurement, and two parallel decoupling capacitors added)

9.3.2 Measurement Results

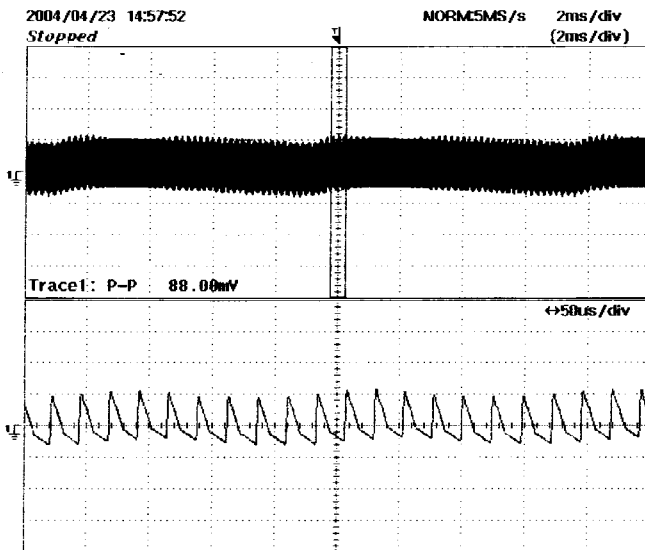

Figure 15 – Ripple, 85 VAC, Full Load
2 ms, 50 mV / div

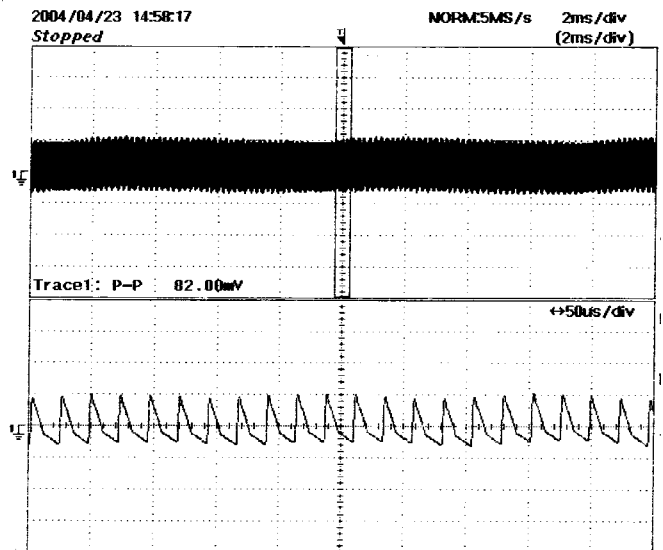

Figure 16 – 5 V Ripple, 115 VAC, Full Load
2 ms, 50 mV / div

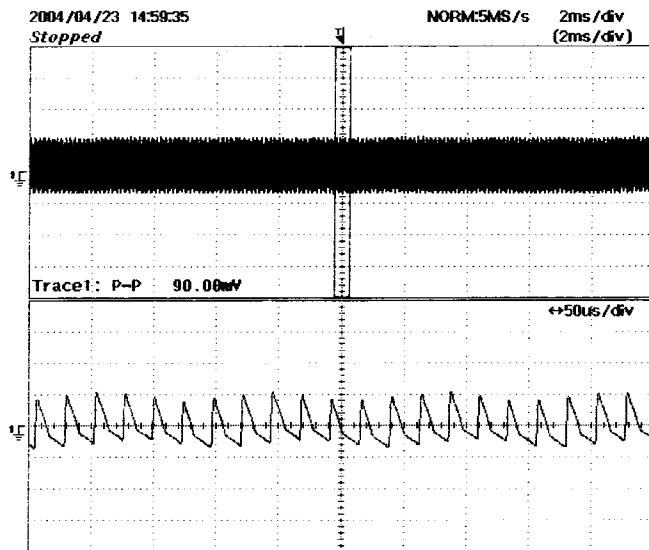

Figure 17 – Ripple, 230 VAC, Full Load
2 ms, 50 mV /div



10 Conducted EMI

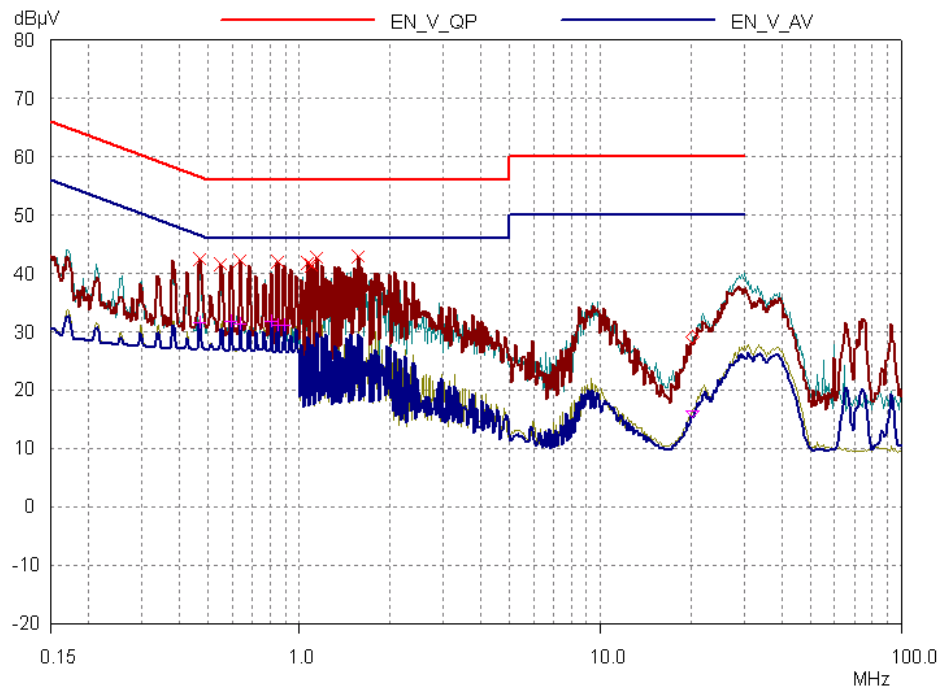

Figure 18 – Conducted EMI, Maximum Steady State Load, 115 VAC, 60 Hz, and EN55022 B Limits – Ungrounded Secondary.

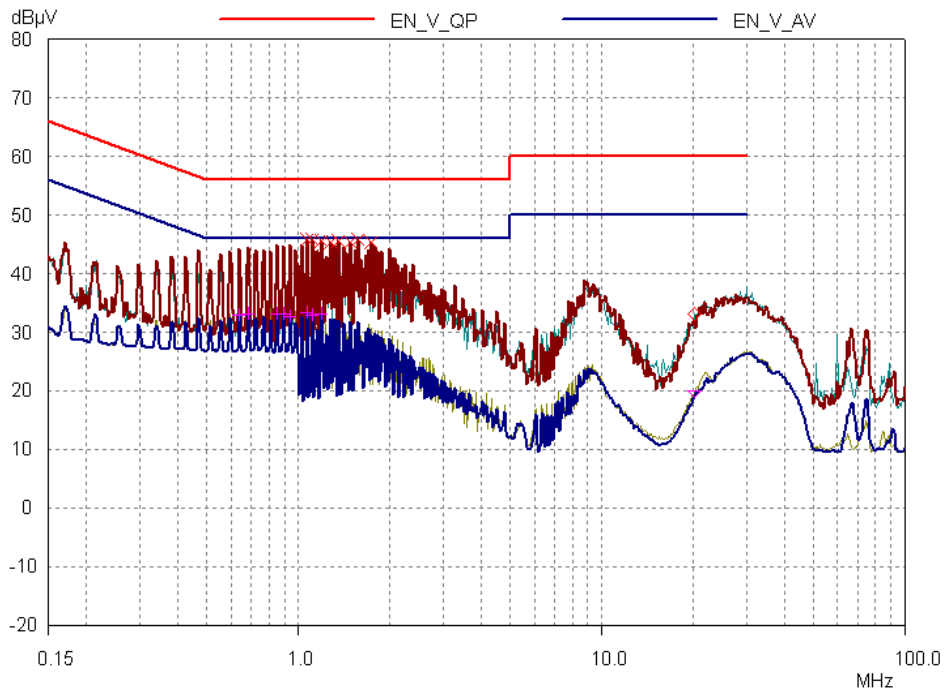

Figure 19 – Conducted EMI, Maximum Steady State Load, 115 VAC, 60 Hz, and EN55022 B Limits – Grounded Secondary



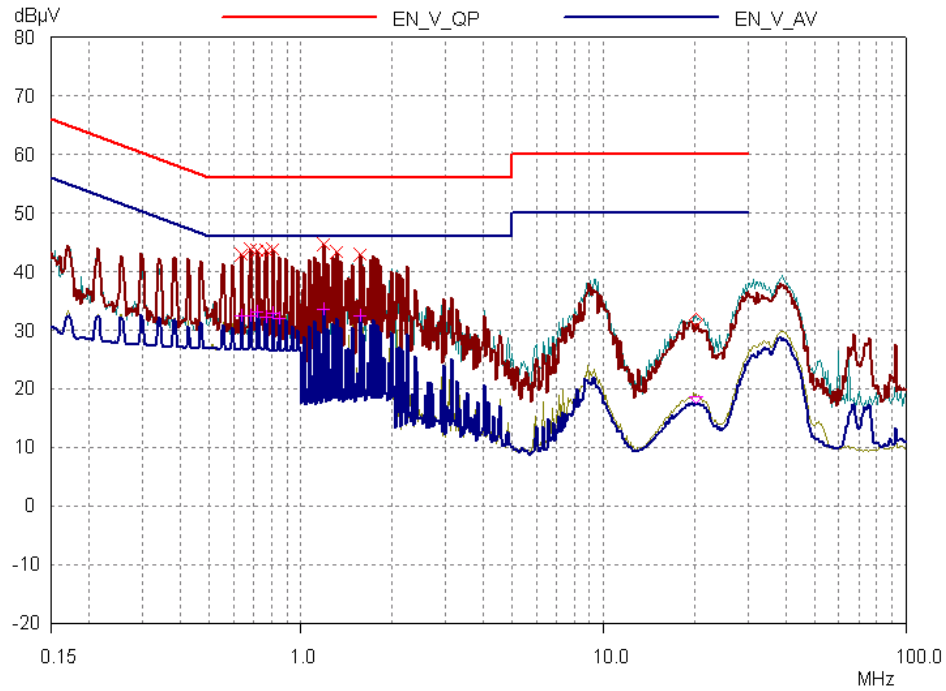

Figure 20 – Conducted EMI, Maximum Steady State Load, 230 VAC, 60 Hz, and EN55022 B Limits - Ungrounded Secondary

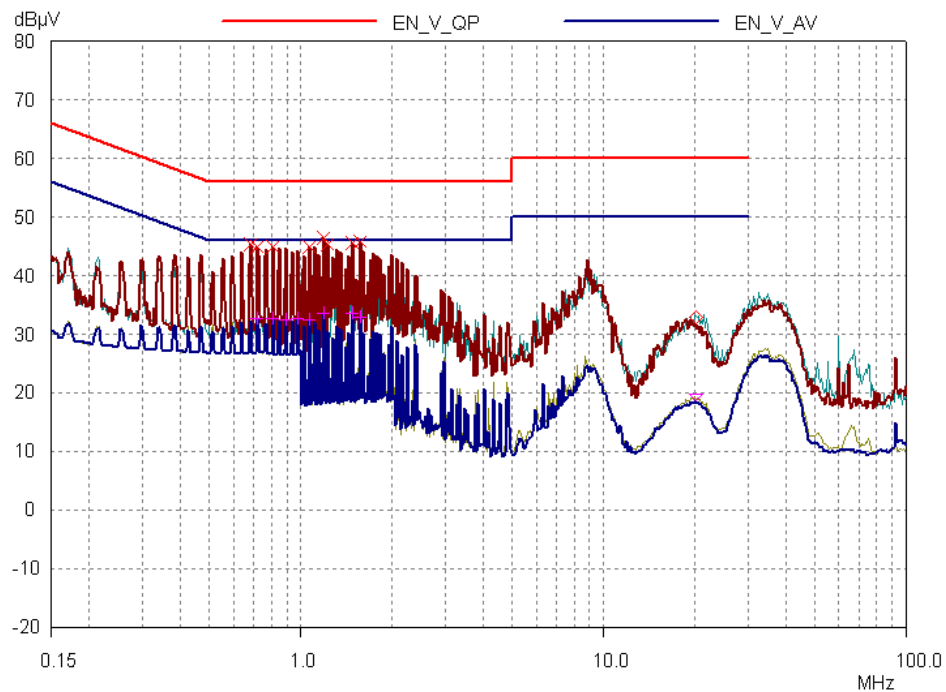

Figure 21 – Conducted EMI, Maximum Steady State Load, 230 VAC, 60 Hz, and EN55022 B Limits - Ungrounded Secondary



11 Revision History

Date	Author	Revision	Description & changes	Reviewed
September 12, 2005	RM	1.0	Initial release	VC / AM



For the latest updates, visit our Web site: www.powerint.com

Power Integrations may make changes to its products at any time. Power Integrations has no liability arising from your use of any information, device or circuit described herein nor does it convey any license under its patent rights or the rights of others. POWER INTEGRATIONS MAKES NO WARRANTIES HEREIN AND SPECIFICALLY DISCLAIMS ALL WARRANTIES INCLUDING, WITHOUT LIMITATION, THE IMPLIED WARRANTIES OF MERCHANTABILITY, FITNESS FOR A PARTICULAR PURPOSE, AND NON-INFRINGEMENT OF THIRD PARTY RIGHTS.

PATENT INFORMATION

The products and applications illustrated herein (including circuits external to the products and transformer construction) may be covered by one or more U.S. and foreign patents or potentially by pending U.S. and foreign patent applications assigned to Power Integrations. A complete list of Power Integrations' patents may be found at www.powerint.com.

The PI Logo, **TOPSwitch**, **TinySwitch**, **LinkSwitch**, and **EcoSmart** are registered trademarks of Power Integrations. **PI Expert** and **DPA-Switch** are trademarks of Power Integrations.

© Copyright 2004, Power Integrations.

Power Integrations Worldwide Sales Support Locations

WORLD HEADQUARTERS

5245 Hellyer Avenue,
San Jose, CA 95138, USA
Main: +1-408-414-9200
Customer Service:
Phone: +1-408-414-9665
Fax: +1-408-414-9765
e-mail:
usasales@powerint.com

CHINA (SHANGHAI)

Rm 807, Pacheer,
Commercial Centre,
555 Nanjing West Road,
Shanghai, 200041, China
Phone: +86-21-6215-5548
Fax: +86-21-6215-2468
e-mail:
chinasales@powerint.com

CHINA (SHENZHEN)

Rm# 1705, Bao Hua Bldg.
1016 Hua Qiang Bei Lu,
Shenzhen, Guangdong,
518031, China
Phone: +86-755-8367-5143
Fax: +86-755-8377-9610
e-mail:
chinasales@powerint.com

APPLICATIONS HOTLINE

World Wide +1-408-414-9660

GERMANY

Rueckertstrasse 3,
D-80336, Munich, Germany
Phone: +49-895-527-3910
Fax: +49-895-527-3920
e-mail: eurosales@powerint.com

INDIA (TECHNICAL SUPPORT)

Innovatech
261/A, Ground Floor
7th Main, 17th Cross,
Sadashivanagar
Bangalore, India, 560080
Phone: +91-80-5113-8020
Fax: +91-80-5113-8023
e-mail: indiasales@powerint.com

ITALY

Via Vittorio Veneto 12, Bresso,
Milano,
20091, Italy
Phone: +39-028-928-6001
Fax: +39-028-928-6009
e-mail: eurosales@powerint.com

APPLICATIONS FAX

World Wide +1-408-414-9760

JAPAN

Keihin-Tatemono 1st Bldg.
12-20 Shin-Yokohama,
2-Chome,
Kohoku-ku, Yokohama-shi,
Kanagawa 222-0033, Japan
Phone: +81-45-471-1021
Fax: +81-45-471-3717
e-mail:
japansales@powerint.com

KOREA

8th Floor, DongSung Bldg.
17-8 Yoido-dong,
Youngdeungpo-gu,
Seoul, 150-874, Korea
Phone: +82-2-782-2840
Fax: +82-2-782-4427
e-mail:
koreasales@powerint.com

SINGAPORE

51 Newton Road,
#15-08/10 Goldhill Plaza,
Singapore, 308900
Phone: +65-6358-2160
Fax: +65-6358-2015
e-mail:
singaporesales@powerint.com

TAIWAN

17F-3, No. 510,
Chung Hsiao E. Rd., Sec. 5,
Taipei, Taiwan 110, R.O.C.
Phone: +886-2-2727-1221
Fax: +886-2-2727-1223
e-mail:
taiwansales@powerint.com

UK (EUROPE & AFRICA HEADQUARTERS)

1st Floor, St. James's House
East Street
Farnham, Surrey GU9 7TJ
United Kingdom
Phone: +44-1252-730-140
Fax: +44-1252-727-689
e-mail: eurosales@powerint.com

ER or EPR template – Rev 3.6 – Single sided

