



Design Example Report

Title	<i>46 W Power Supply using TOP246Y</i>
Specification	Input: 90 – 265 VAC Output: 5 V / 2 A, 12 V / 3 A
Application	LCD Monitor
Author	Power Integrations Applications Department
Document Number	DER-94
Date	September 12, 2005
Revision	1.0

Notable Features

- Low Standby Power Consumption (< 1 W Input for 0.3 W Output @ 265 VAC)
- Meets 12 V Regulation Requirements for Low Cost LCD Panel without Linear Regulator
- Meets Output Ripple Requirements During 12 V Burst Load Test
- Meets 5 V LPS Standard without Fuse (Auto-restart)
- Built-In OVP (Auto-restart)
- Meets CISPR22B Conducted EMI with Margin
- High Efficiency (81% Minimum, 84% Typical)
- Low Parts Count
- No TVS for Primary Snubber

The products and applications illustrated herein (including circuits external to the products and transformer construction) may be covered by one or more U.S. and foreign patents or potentially by pending U.S. and foreign patent applications assigned to Power Integrations. A complete list of Power Integrations' patents may be found at www.powerint.com.

Table Of Contents

1	Introduction.....	4
2	Power Supply Specification.....	5
3	Schematic.....	6
4	Circuit Description	8
4.1	Input EMI Filtering	8
4.2	TOPSwitch Primary.....	8
4.3	Output Rectification.....	8
4.4	Output Feedback.....	8
4.5	Active Preload/Output Protection	9
5	Printed Circuit Layout	10
6	Bill Of Materials	11
7	Transformer Specification.....	13
7.1	Electrical Diagram	13
7.2	Electrical Specifications.....	13
7.3	Materials.....	14
7.4	Transformer Build Diagram	14
7.5	Transformer Construction.....	15
7.6	Transformer Spreadsheet	17
8	Performance Data	20
8.1	Efficiency.....	20
8.2	Standby Input Power.....	20
8.3	Cross Regulation Matrix.....	21
8.4	Load Regulation Matrix, 90VAC	21
8.5	5V Power Limit.....	21
9	Thermal Performance.....	22
10	Waveforms.....	23
10.1	Drain Voltage and Current, Normal Operation	23
10.2	Output Voltage Start-up Profile	23
10.3	Load Transient Response (75% to 100% Load Step)	24
10.4	Overvoltage Protection.....	24
11	Output Ripple.....	25
11.1	Ripple Measurement Technique	25
11.2	Measurement Results	26
11.3	Ripple with 12 V Burst Load	27
12	Gain-Phase Measurements	28
12.1	115 VAC Maximum Load	28
12.2	230 VAC Maximum Load	29
13	Line Transient Testing	30
14	Conducted EMI.....	31
15	Revision History	33



Important Notes:

Although this board is designed to satisfy safety isolation requirements, the engineering prototype has not been agency approved. Therefore, all testing should be performed using an isolated source to provide power to the prototype board.

Design Reports contain a power supply design specification, schematic, bill of materials, and transformer documentation. Performance data and typical operation characteristics are included. Typically only a single prototype has been built.



1 Introduction

This document is an engineering report describing a universal input, 2-output, 46 W power supply utilizing a TOP246. This power supply is intended as a reference design for LCD monitor internal power supplies

The document contains the power supply specification, schematic, bill of materials, transformer documentation, printed circuit layout, and performance data.

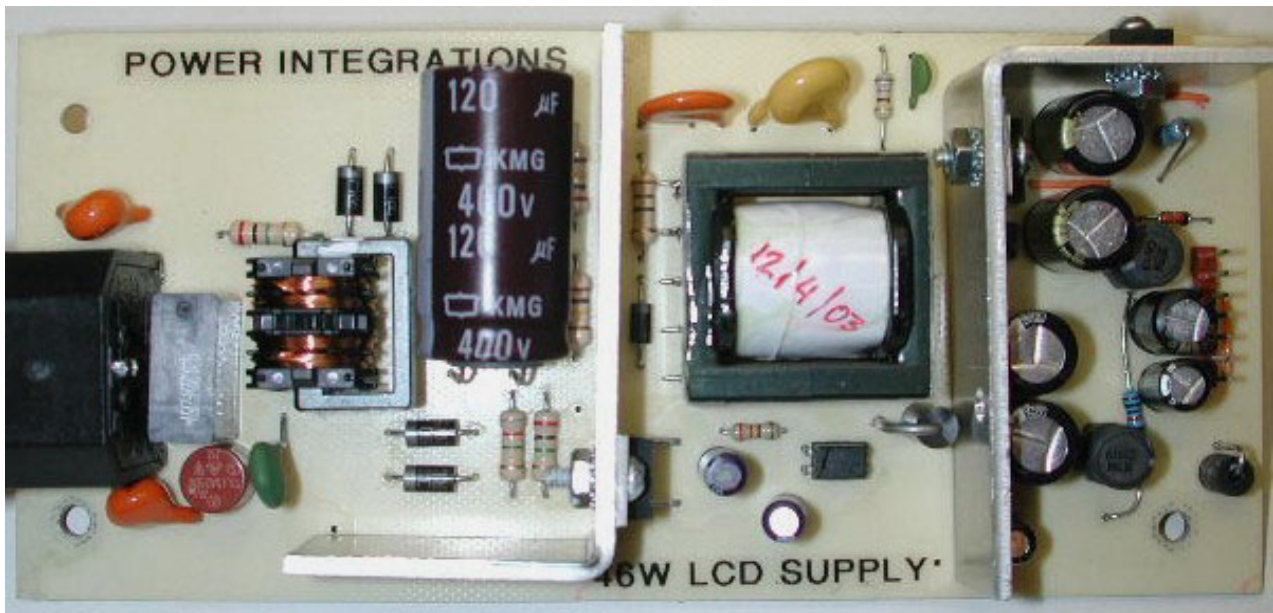

Figure 1 – LCD Monitor Internal Power Supply Picture

2 Power Supply Specification

Description	Symbol	Min	Typ	Max	Units	Comment
Input						
Voltage	V_{IN}	90		265	VAC	3 Wire
Frequency	f_{LINE}	47	50/60	64	Hz	
Standby Input Power (265 VAC)				0.9W	W	5V @ 60ma, 12V @ 0.0ma
Output						
Output Voltage 1	V_{OUT1}	4.75	5.00	5.25	V	± 5%
Output Ripple Voltage 1	$V_{RIPPLE1}$			100	mV	20 MHz Bandwidth, burst load
Output Current 1	I_{OUT1}	0	1	2.0	A	
Output Voltage 2	V_{OUT1}	11.4	12	12.6	V	
Output Ripple Voltage 2	$V_{RIPPLE2}$			250	mV	20MHz bandwidth, burst load
Output Current 2	I_{OUT2}	1	2.5	3	A	
Total Output Power			35	46		
Continuous Output Power	P_{OUT}		35	46	W	
Peak Output Power	P_{OUT_PEAK}			46	W	
Efficiency	η	81	84		%	Measured at P_{OUT} (46 W), 25 °C
Environmental						
Conducted EMI			Meets CISPR22B / EN55022B			
Safety			Designed to meet IEC950, UL1950 Class II			
Surge		3 4			kV	1.2/50 μ s surge, IEC 1000-4-5, Series Impedance: Differential Mode 2 Ω Common Mode: 12 Ω
Surge		TBD			kV	100 kHz ring wave, 500 A short circuit current, differential and common mode
Ambient Temperature	T_{AMB}	0		60	°C	Free convection, sea level



3 Schematic

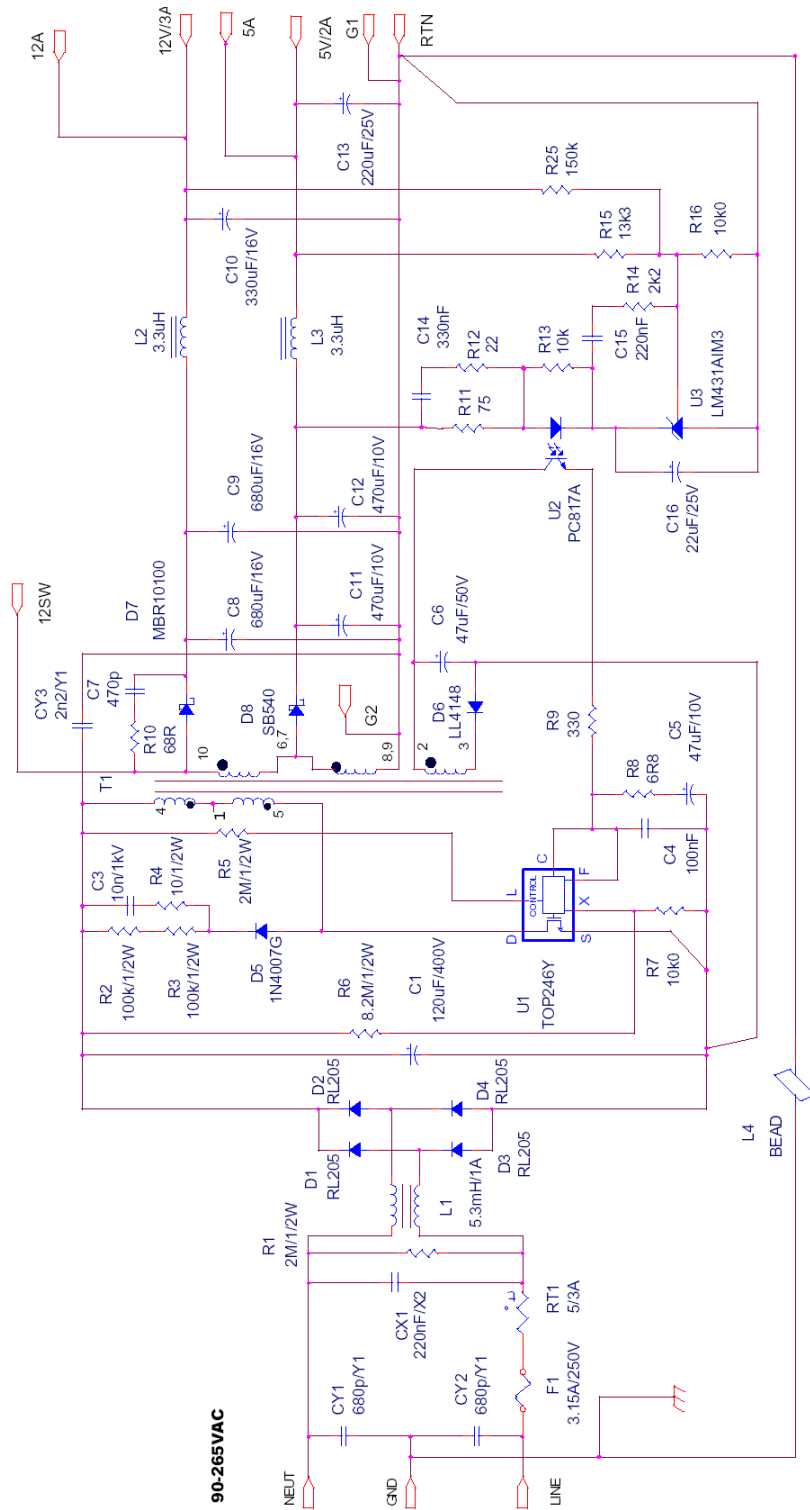

Figure 2 – Schematic (page 1)



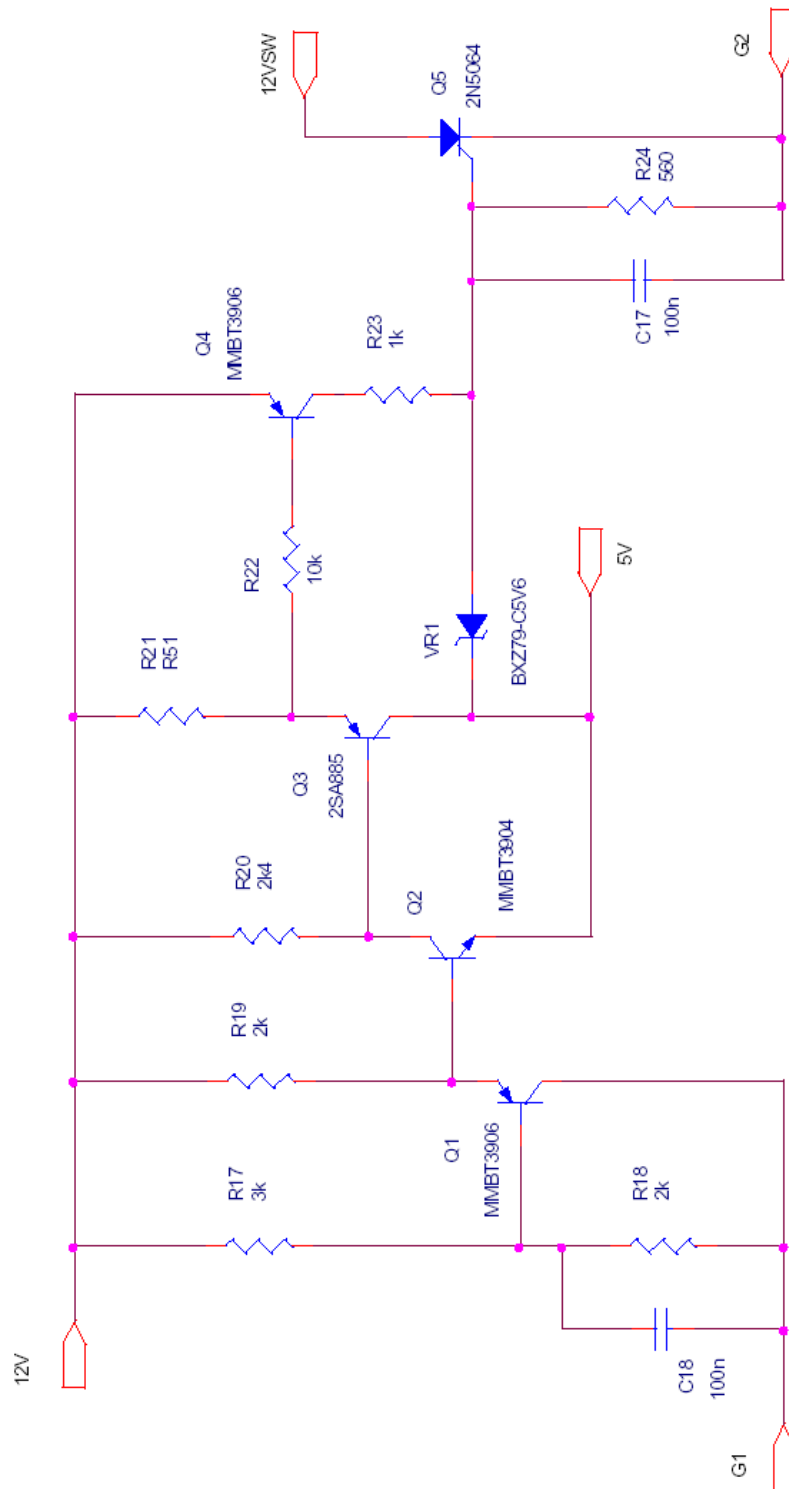

Figure 3 – Schematic (page 2)



4 Circuit Description

The schematic in Figure 1 shows an off-line flyback converter using the TOP246. The circuit is designed for 90 VAC to 265 VAC input, with two outputs: 5 V / 2 A and 12 V / 3 A.

4.1 Input EMI Filtering

Capacitor CX1 and the L1 leakage inductance filter differential mode conducted EMI. Inductor L1 and CY1-CY3 filter common mode conducted EMI. L4 is a ferrite bead connected between secondary return and safety ground that reduces high frequency (> 20MHz) conducted EMI.

4.2 TOPSwitch Primary

The AC line voltage is rectified and filtered to generate a high voltage DC bus via D1-4 and C1. Diode D5, C3, and R2-4 clamp leakage spikes generated when the MOSFET in U1 switches off. D5 is a glass-passivated normal recovery rectifier. The slow, controlled recovery time of D5 allows energy stored in C3 to be recycled back to the high voltage bus, significantly increasing efficiency. A normal (non-passivated) 1N4007 should not be substituted for the glass-passivated device. The U1 "F" pin is connected to the control pin to program 65kHz operating frequency. Resistor R5 sets the turn-on voltage of the supply to approximately 76 VAC. C4 bypasses the U1 control pin. C5 has three functions. It provides the energy required by U1 during startup, sets the auto-restart frequency during fault conditions, and also acts to roll off the gain of U1 as a function of frequency. R8 adds a zero to the control loop to stabilize the power supply control loop. Resistor R7 programs the U1 current limit to 75% of the nominal value. Resistor R6 acts to depress the U1 current limit as a function of line voltage, making the maximum overload power more independent of line voltage.

4.3 Output Rectification

The T1 output is rectified and filtered by D7 and C8-9 for the 12V output, and by D8 and C11-12 for the 5V output. Components C8 and R12 provide snubbing for D12. Components L2, L3, C10, and C13 provide additional high frequency output filtering.

4.4 Output Feedback

Resistors R15 and R16 are used to set the +5V main output voltage. Resistor R25 provides a small amount of feedback from the +12V output to improve cross regulation. Shunt regulator U3 drives optocoupler U2 through resistor R11 to provide feedback information to the U1 control pin. The optocoupler output also provides power to U1 during normal operating conditions. Capacitor C16 applies drive to the optocoupler during supply startup to reduce output voltage overshoot. Capacitor C15 and R14 provide frequency compensation for error amplifier U3. Components C14 and R12 improve the control loop phase margin by providing gain and phase boost near the control loop 0dB crossover frequency.

Components C5, C14, C15, R8, R11, R12, and R14 all play a role in compensating the power supply control loop. Capacitor C5 rolls off the gain of U1 at relatively low



frequency. Resistor R8 provides a zero to cancel the phase shift of C5. Resistor R11 sets the gain of the direct signal path from the supply output through U2 and U3. Components C15 and R14 reduce the high frequency gain of U3, while C14 and R12 provide gain and phase boost near the control loop 0dB crossover frequency.

4.5 Active Preload/Output Protection

The components shown in Figure 3 provide 12 V active loading, 5 V overload protection, and overvoltage protection for the power supply. The active preload function improves cross regulation, especially when there is light or no load on the +12 V output and maximum load on the +5 V output. The improvement in cross regulation makes the 12 V output suitable for use with low cost LCD panels and removes the need for a 12 V linear post regulator. The circuit provides overload protection for the 5 V output during LPS testing of the +5 V output, eliminating the need for a 5 V fuse. Finally, the circuit provides output overvoltage protection with auto-restart.



5 Printed Circuit Layout

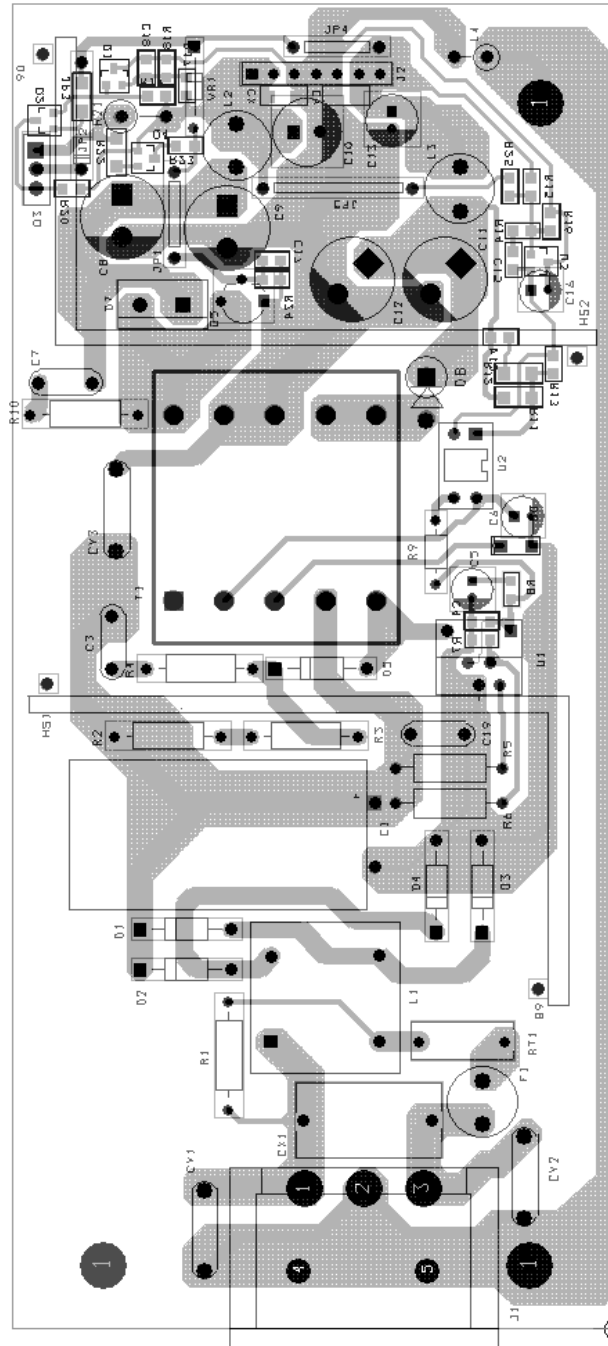

Figure 4 – Printed Circuit Layout



6 Bill Of Materials

Generic LCD Monitor Supply, 12/010/03

Item	Qty	Reference	Description	P/N	Manufacturer
1	1	U1		TOP246Y	Power Integrations
2	1	U2	Optocoupler, 80-160% CTR	PC817A	Sharp
3	1	U3	Shunt regulator, SOT-23	LM431AIM3	National
4	2	Q1,4	Transistor, PNP General Purpose, SOT-23	MMBT3906	Diodes, Inc.
5	1	Q2	Transistor, NPN, General Purpose, SOT-23	MMBT3904	Diodes, Inc.
6	1	Q3	Transistor, PNP, 35V, 1A, TO-126	2SA885	Panasonic
7	1	Q5	SCR, sensitive gate, 200V, 0.8A, TO-92	2N5064 or equivalent	
8	1	VR1	Zener Diode, 5.6V,	BZX79-C5V6 500mW	
9	1	RT1	Thermistor, 5Ω, 3A	SCK053	Thinking Electronics
10	4	D1-4	Diode, 2A, 600V	RL205	Rectron
11	1	D5	1000V, 1A, GP	1N4007G	Diodes, Inc
12	5	D6	Diode, Signal	DL4148	Diodes, Inc.
13	1	D7	Schottky, 100V, 10A, MBR10100		General Semiconductor
14	1	D8	Schottky, 5A, 40V,	SB540	General Semiconductor
15	1	CX1	X2 capacitor, 220nF		Any
16	2	CY1,CY2	Y1 Capacitor, 680pF		Any
17	1	CY3	Y1 Capacitor, 2.2nF		Any
18	1	C1	120 uF, 400V, 105C, 18 X 35 mm		Any
19	1	C3	Ceramic Disc, 10nF, 1kV		Any
20	3	C4,17,18	100 nF, 25V, ceramic 0805		Any
21	1	C5	47 uF, 10V, 105C, 5 X11mm		Any
22	1	C6	47 uF, 50V, 105C, 8 X 11 mm		Any
23	1	C7	Capacitor, ceramic, 470pF, 100V		Any
24	2	C8,9	680 uF, 16V, 10 X16 mm, ESR ≤ 68 mΩ		Any
25	2	C10	330 uF, 16V, 8 X 11.5 mm ESR ≤ 117 mΩ		Any
26	2	C11,12	470 uF, 10V, 10 X 12.5 mm 80-160% CTR		Any
27	1	C13	220 uF, 25V, 105C, 8 X 11.2 mm		Any
28	1	C14	Capacitor, ceramic, 330nF, 16V, 0805		Any
29	1	C15	220 nF, 16V Ceramic, 0805		Any
30	1	C16	22 uF, 25V, 105C, 5X11		Any
31	1	T1	Transformer, EER28		Custom
32	1	L1	Balun, 5.3 mH, 1A		Any
33	2	L2,3	Inductor, 3.3uH, 3A		Any
34	1	L4	Ferrite Bead, 5.1mm dia X 2643022401 6.35 mm long, 1.45 mm hole		Fair-Rite
35	1	F1	Fuse, 3.15A, 250 VAC		Any
36	2	R1,5	2M, 5%, 1/2W		Any
37	2	R2,3	100k, 5%, 1/2W		Any
38	1	R4	10R, 5%, 1/2W		Any
39	1	R6	8.2M, 5%, 1/2W		Any
40	2	R7,16	10kΩ, 1%, 0805		Any
41	1	R8	6R8, 5%, 1206		Any
42	1	R9	330, 5%, 1/8W		Any
43	1	R10	68R, 5%, 1/2W		Any
44	1	R11	75R, 5%, 1206		Any
45	1	R12	22R, 5%, 1206		Any
46	1	R13	10k, 5%, 0805		Any



47	1	R14	2k2, 5%, 0805	Any
48	1	R15	13k3, 1%, 0805	Any
49	1	R17	3k, 5%, 0805	Any
50	2	R18,19,	2k. 5%, 0805	Any
51	1	R20	2.4k, 5%, 0805	Any
52	1	R21	0.51 ohm. 5%, 1W	Any
53	1	R22	10k, 5%, 1206	Any
54	1	R23	1k, 5%, 0805	Any
55	1	R24	560, 5%, 0805	Any
56	1	R25	150k, 1%, 0805	Any
57	1	JP3	0 ohm, 1206	Any



7 Transformer Specification

7.1 Electrical Diagram

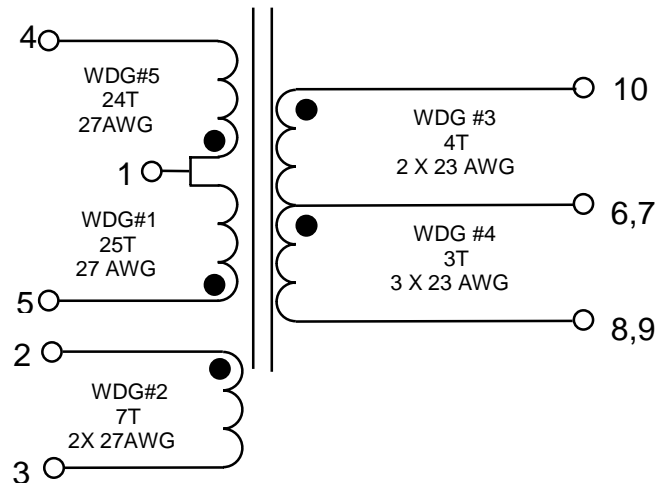

Figure 5 –Transformer Electrical Diagram

7.2 Electrical Specifications

Electrical Strength	60Hz 1 second, from Pins 1-5 to Pins 6-10	3000 VAC
Creepage	Between Pins 1-5 and Pins 6-10	6 mm (Min.)
Primary Inductance	Pins 1-2, all other windings open, measured at 10KHz, 0.4VRMS	594 μ H, \pm 10%
Resonant Frequency	Pins 1-2, all other windings open, measured at 10KHz, 0.4VRMS	2 MHz (Min.)
Primary Leakage Inductance	Pins 1-2, with Pins 6-10 shorted, measured at 10KHz, 0.4V RMS	15 μ H (Max.)

7.3 Materials

Item	Description
[1]	Core: 1 Pair EER28 Nippon Ceramic NC-2H or equivalent. Gapped for A_L of 247 nH/T^2
[2]	Bobbin: 10 pin EER28, Horizontal Low Profile Pin Shine P-2834
[3]	Magnet Wire: #27AWG Solderable Double Coated
[4]	Magnet Wire: #23AWG Solderable Double Coated
[5]	Tape, 3M # 1298 or equiv. 17 mm wide
[6]	Tape, 3M #1298 or equiv. 11 mm wide
[7]	Tape, Polyester Web, 3M #44 or equivalent, 3mm wide (minimum)
[8]	Teflon Sleeveing, 0.4mm wall thickness, 24 ga
[9]	Teflon Sleeveing, 0.4mm wall thickness, 22 ga
[10]	Varnish

7.4 Transformer Build Diagram

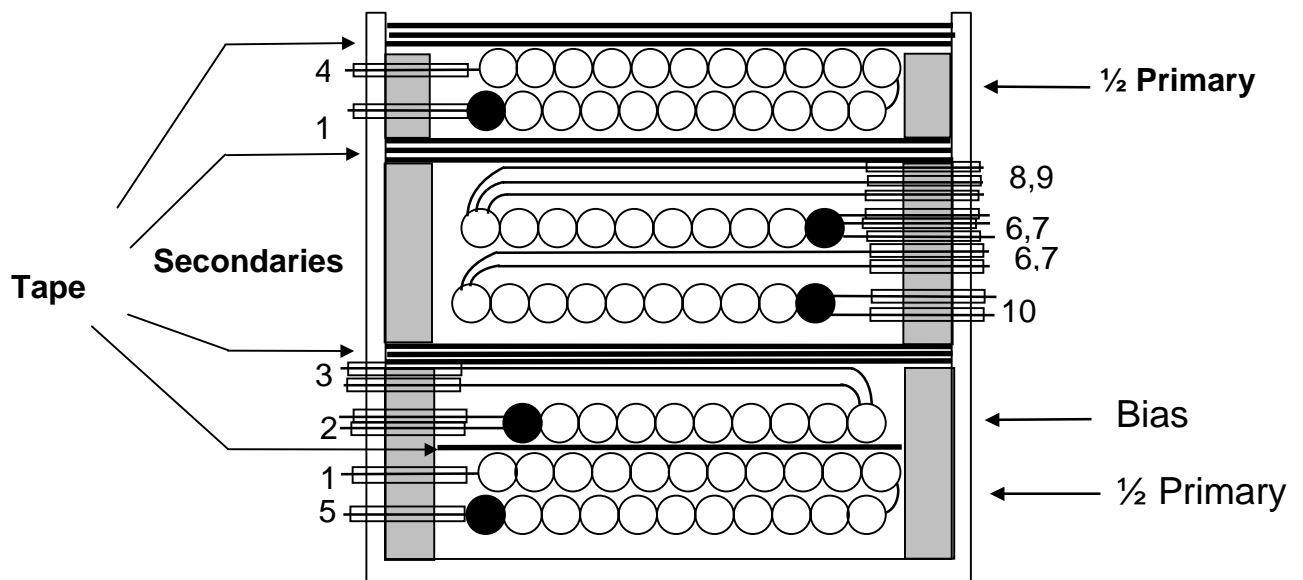

Figure 6 – Transformer Build Diagram

7.5 Transformer Construction

		Winder Direction
Core Preparation	Using two 35 mm long pieces of item [5] for each core, wrap both core halves (item [1]) as shown in Figure 1.	
Primary Margins	Using item [7], apply a 3 mm wide margin on each side of the bobbin winding area. Match margin height to primary and bias windings.	
$\frac{1}{2}$ Primary - Basic Insulation	Start at Pin 5. Wind 25 turns of item [3] in 1 layer. Finish on Pin 1. Sleeve start and finish leads (item [8]).	Forward
Basic Insulation	Use one layer of item [6] for basic insulation.	
Bifilar Bias winding	Starting at pin 2, wind 7 bifilar turns of item [3]. Spread turns evenly across bobbin. Finish at pin 3. Sleeve start and finish leads (item [8]).	Forward
Reinforced Insulation	Use three layers of item [6] for reinforced insulation.	
Secondary Margins	Using item [7], apply a 3 mm wide margin on each side of the bobbin winding area. Match margin height to secondary windings.	
12V Bifilar Secondary Winding	Start at Pin 10. Wind 4 bifilar turns of item [4]. Spread turns evenly across bobbin. Finish on Pin 7. Sleeve start and finish leads (item [9]).	Forward
5V Trifilar Secondary Winding	Start at Pins 6 and 7. Forward wind 3 trifilar turns of item [4] directly on top of 12 V winding. Spread turns evenly across bobbin. Finish on Pins 8 and 9. Sleeve start and finish leads (item [9]).	Forward
Primary Margins	Using item [7], apply a 3 mm wide margin on each side of the bobbin winding area. Match margin height to primary winding.	
Reinforced Insulation	Use three layers of item [6] for reinforced insulation.	
$\frac{1}{2}$ Primary - Outer Wrap	Start at Pin 1. Wind 24 turns of item [3] in 1 layer. Finish on Pin 4. Sleeve start and finish leads (item [8]).	Forward
Outer Wrap	Wrap windings with 3 layers of tape [item [5]].	
Assembly	Assemble bobbin and core halves. Varnish impregnate assembled transformer (item [10]).	



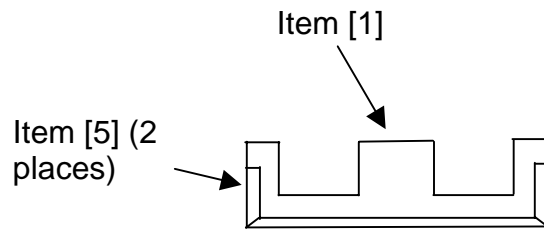

Figure 7 – Core Tape Wrap Drawing



7.6 Transformer Spreadsheet

ACDC_TOPGX_Rev1.2_052901 Copyright Power Integrations Inc. 2001		INPUT	INFO	INFO	OUTPUT	OUTPUT	UNIT	TOP_GX_052901.xls: TOPSwitch-GX Continuous/Discontinuous Flyback Transformer Design Spreadsheet Customer
ENTER APPLICATION VARIABLES								
VACMIN		90					Volts	Minimum AC Input Voltage
VACMAX		265					Volts	Maximum AC Input Voltage
fL		50					Hertz	AC Mains Frequency
VO		5					Volts	Output Voltage
PO		45					Watts	Output Power
n		0.8						Efficiency Estimate
Z		0.5						Loss Allocation Factor
VB		12					Volts	Bias Voltage
tC		3					mSeconds	Bridge Rectifier Conduction Time Estimate
CIN		120					uFarads	Input Filter Capacitor
ENTER TOPSWITCH-GX VARIABLES								
TOP-GX		TOP246					Universal	115 Doubled/230V
Chosen Device		TOP246		TOP246 Power Out		Power Out	90W	150W
KI		0.8						External Ilimit reduction factor (KI=1.0 for default ILIMIT, KI <1.0 for lower ILIMIT)
ILIMITMIN				1.944		1.944 Amps		Use 1% resistor in setting external ILIMIT
ILIMITMAX				2.376		2.376 Amps		Use 1% resistor in setting external ILIMIT
Frequency - (F)=132kHz, (H)=66kHz		H						Half (H) frequency option - 66kHz
fS		65000		6.50E+04		6.50E+04 Hertz		TOPSwitch-GX Switching Frequency: Choose between 132 kHz and 66 kHz
fSmin				6.15E+04		6.15E+04 Hertz		TOPSwitch-GX Minimum Switching Frequency
fSmax				7.05E+04		7.05E+04 Hertz		TOPSwitch-GX Maximum Switching Frequency
VOR		90					Volts	Reflected Output Voltage
VDS		10					Volts	TOPSwitch on-state Drain to Source Voltage
VD		0.5					Volts	Output Winding Diode Forward Voltage Drop
VDB		0.7					Volts	Bias Winding Diode Forward Voltage Drop
KP		0.70						Ripple to Peak Current Ratio (0.4 < KRP < 1.0 : 1.0< KDP<6.0)
ENTER TRANSFORMER CORE/CONSTRUCTION VARIABLES								
Core Type		EER28					P/N:	PC40EER28-Z
Core			EER28	EER28			P/N:	BEER-28-1112CPH
Bobbin			EER28_BOBBIN	EER28_BOBBIN				Core Effective Cross Sectional Area
AE				0.821		0.821 cm^2		
LE				6.4		6.4 cm		Core Effective Path Length
AL				2870		2870 nH/T^2		Ungapped Core Effective Inductance
BW		17.2			17.2	17.2 mm		Bobbin Physical Winding Width
M		3					mm	Safety Margin Width (Half the Primary to Secondary Creepage Distance)
L		2						Number of Primary Layers

NS	3			Number of Secondary Turns
DC INPUT VOLTAGE PARAMETERS				
VMIN	98	98	Volts	Minimum DC Input Voltage
VMAX	375	375	Volts	Maximum DC Input Voltage
CURRENT WAVEFORM SHAPE PARAMETERS				
DMAX	0.51	0.51		Maximum Duty Cycle
Iavg	0.57	0.57	Amps	Average Primary Current
IP	1.75	1.75	Amps	Peak Primary Current
IR	1.22	1.22	Amps	Primary Ripple Current
IRMS	0.84	0.84	Amps	Primary RMS Current
TRANSFORMER PRIMARY DESIGN PARAMETERS				
LP	594	594	uHenries	Primary Inductance
NP	49	49		Primary Winding Number of Turns
NB	7	7		Bias Winding Number of Turns
ALG	247	247	nH/T ²	Gapped Core Effective Inductance
BM	2572	2572	Gauss	Maximum Flux Density at PO, VMIN (BM<3000)
BP	3502	3502	Gauss	Peak Flux Density (BP<4200)
BAC	900	900	Gauss	AC Flux Density for Core Loss Curves (0.5 X Peak to Peak)
ur	1780	1780		Relative Permeability of Ungapped Core
LG	0.38	0.38	mm	Gap Length (Lg > 0.1 mm)
BWE	22.4	22.4	mm	Effective Bobbin Width
OD	0.46	0.46	mm	Maximum Primary Wire Diameter including insulation
INS	0.06	0.06	mm	Estimated Total Insulation Thickness (= 2 * film thickness)
DIA	0.39	0.39	mm	Bare conductor diameter
AWG	27	27	AWG	Primary Wire Gauge (Rounded to next smaller standard AWG value)
CM	203	203	Cmils	Bare conductor effective area in circular mils
CMA	241	241	Cmils/Amp	Primary Winding Current Capacity (200 < CMA < 500)
TRANSFORMER SECONDARY DESIGN PARAMETERS (SINGLE OUTPUT / SINGLE OUTPUT EQUIVALENT)				
Lumped parameters				
ISP	28.56	28.56	Amps	Peak Secondary Current
ISRMS	13.67	13.67	Amps	Secondary RMS Current
IO	9.00	9.00	Amps	Power Supply Output Current
IRIPPLE	10.29	10.29	Amps	Output Capacitor RMS Ripple Current
CMS	2735	2735	Cmils	Secondary Bare Conductor minimum circular mils
AWGS	15	15	AWG	Secondary Wire Gauge (Rounded up to next larger standard AWG value)
DIAS	1.45	1.45	mm	Secondary Minimum Bare Conductor Diameter
ODS	3.73	3.73	mm	Secondary Maximum Outside Diameter for Triple Insulated Wire
INSS	1.14	1.14	mm	Maximum Secondary Insulation Wall Thickness



VOLTAGE STRESS PARAMETERS

VDRAIN		584	584 Volts	Maximum Drain Voltage Estimate (Includes Effect of Leakage Inductance)
PIVS		28	28 Volts	Output Rectifier Maximum Peak Inverse Voltage
PIVB		65	65 Volts	Bias Rectifier Maximum Peak Inverse Voltage

TRANSFORMER SECONDARY DESIGN PARAMETERS (MULTIPLE OUTPUTS)

1st output

VO1	5.0		Volts	Output Voltage
IO1	2.000		Amps	Output DC Current
PO1		10.00	10.00 Watts	Output Power
VD1	0.5		Volts	Output Diode Forward Voltage Drop
NS1		3.00	3.00	Output Winding Number of Turns
ISRMS1		3.039	3.039 Amps	Output Winding RMS Current
IRIPPLE1		2.29	2.29 Amps	Output Capacitor RMS Ripple Current
PIVS1		28	28 Volts	Output Rectifier Maximum Peak Inverse Voltage
CMS1		608	608 Cmil	Output Winding Bare Conductor minimum circular mils
AWGS1		22	22 AWG	Wire Gauge (Rounded up to next larger standard AWG value)
DIAS1		0.65	0.65 mm	Minimum Bare Conductor Diameter
ODS1		3.73	3.73 mm	Maximum Outside Diameter for Triple Insulated Wire

2nd output

VO2	12.0		Volts	Output Voltage
IO2	3.000		Amps	Output DC Current
PO2		36.00	36.00 Watts	Output Power
VD2	1.0		Volts	Output Diode Forward Voltage Drop
NS2		7.09	7.09	Output Winding Number of Turns
ISRMS2		4.558	4.558 Amps	Output Winding RMS Current
IRIPPLE2		3.43	3.43 Amps	Output Capacitor RMS Ripple Current
PIVS2		66	66 Volts	Output Rectifier Maximum Peak Inverse Voltage
CMS2		912	912 Cmil	Output Winding Bare Conductor minimum circular mils
AWGS2		20	20 AWG	Wire Gauge (Rounded up to next larger standard AWG value)
DIAS2		0.81	0.81 mm	Minimum Bare Conductor Diameter
ODS2		1.58	1.58 mm	Maximum Outside Diameter for Triple Insulated Wire



8 Performance Data

All measurements performed at room temperature, 60 Hz input frequency, on a *typical unit*.

8.1 Efficiency

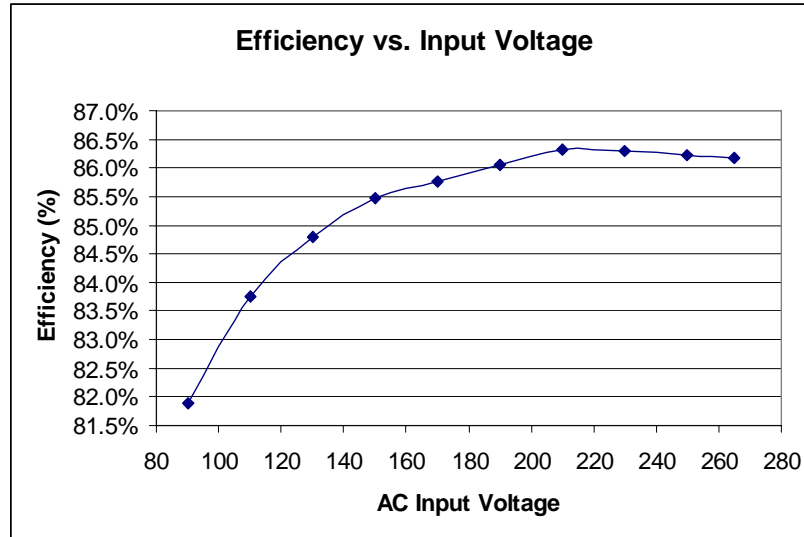

Figure 8 – Efficiency vs. Input Voltage, Full Load, Room Temperature, 60 Hz.

8.2 Standby Input Power

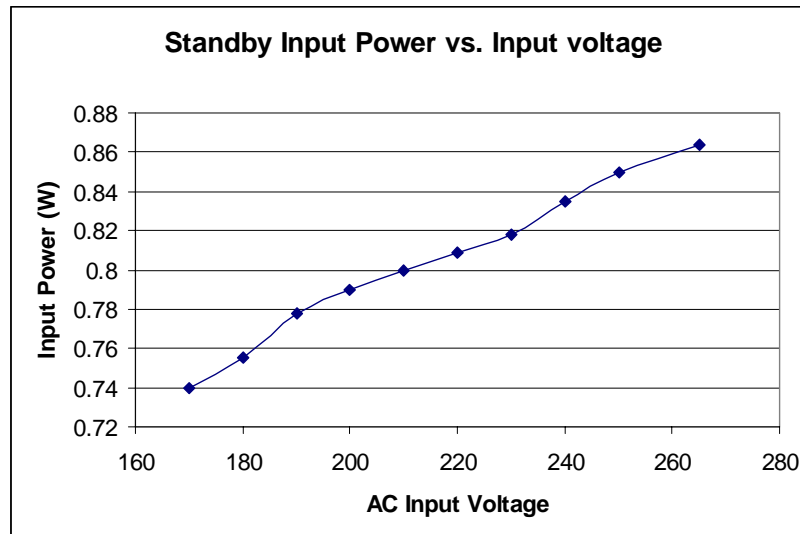

Figure 9 – Standby Input Power Input Power vs. Input Voltage, Room Temperature, 60 Hz. 5V Output = 60mA, No Load on 12V Output



8.3 Cross Regulation Matrix

Vin	Vo1	Io1	Vo2	Io2
90	4.99	2	12.18	3
90	4.96	2	12.51	0
90	5	0	12.05	0
90	5.06	0.1	11.4	3
265	4.99	2	12.12	3
265	4.96	2	12.5	0
265	5.01	0	12.06	0
265	5.06	0.1	11.49	3

8.4 Load Regulation Matrix, 90VAC

Vin	Vo1	Io1	Vo2	Io2
90	5.05	0.1	11.49	3
90	5.04	0.2	11.63	3
90	5.03	0.4	11.73	3
90	5.01	0.8	11.87	3
90	5.01	1	11.91	3
90	5	1.5	12.03	3
90	4.99	2	12.14	3
90	4.96	2	12.48	0
90	4.96	2	12.46	0.1
90	4.96	2	12.44	0.2
90	4.97	2	12.43	0.4
90	4.97	2	12.4	0.8
90	4.98	2	12.37	1
90	4.98	2	12.29	1.5
90	4.98	2	12.21	2
90	4.99	2	12.16	2.5
90	4.99	2	12.12	3

8.5 5V Power Limit

The 5 V power limit was tested at 230 VAC with the 12 V output set to zero load. The 5 V output load was increased from a 2 A load until the protection circuit forced the power supply into auto-restart. This occurred at a 5 V load of 3-4.2 A for the 4 units tested.



9 Thermal Performance

Device case temperatures were measured with an output load of 5 V / 2 A and 12 V / 2 A.

Item	90 VAC	90 VAC
Ambient	60	25
Common Mode Choke (L1)	75	45
Input Rectifier (D4)	78	47
<i>TOPSwitch</i> (U1)	85	53
Transformer (T1)	77	48
5V Rectifier (D8)	88	60
12V Rectifier (D7)	78	50



10 Waveforms

10.1 Drain Voltage and Current, Normal Operation

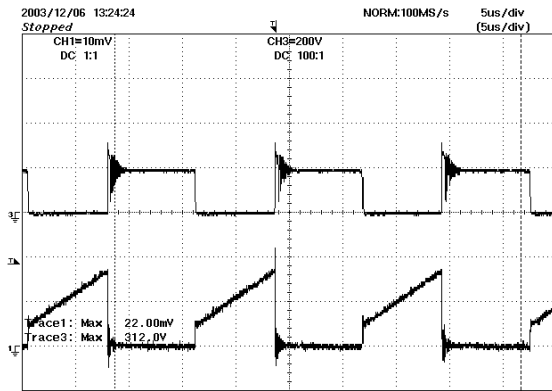

Figure 10 – 90 VAC, Full Load
Upper: V_{DRAIN} , 200 V / div
Lower: I_{DRAIN} , 1 A, 5 μ s / div

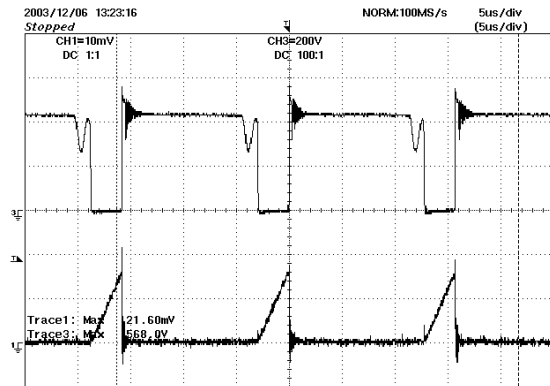

Figure 11 – 265 VAC, Full Load
Upper: V_{DRAIN} , 200 V / div
Lower: I_{DRAIN} , 1 A, 5 μ s/div

10.2 Output Voltage Start-up Profile

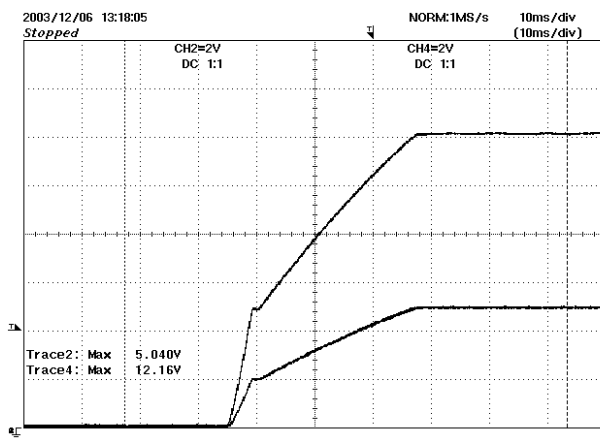

Figure 12 – Start-up Profile, 90 VAC, 10 ms / div.
Top Trace – 12 V Output, 2 V / div
Bottom Trace – 5 V Output, 2 V / div

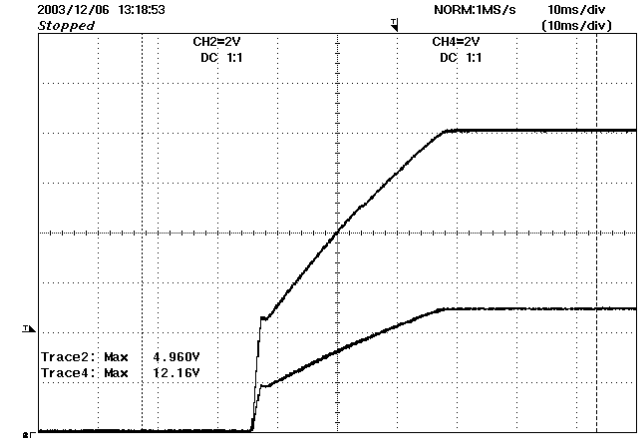

Figure 13 – Start-up Profile, 265 VAC, 10 ms / div.
Top Trace – 12 V Output, 2 V / div
Bottom Trace – 5 V Output, 2 V / div



10.3 Load Transient Response (75% to 100% Load Step)

In the figures shown below, the oscilloscope was triggered using the load current step as a trigger source.

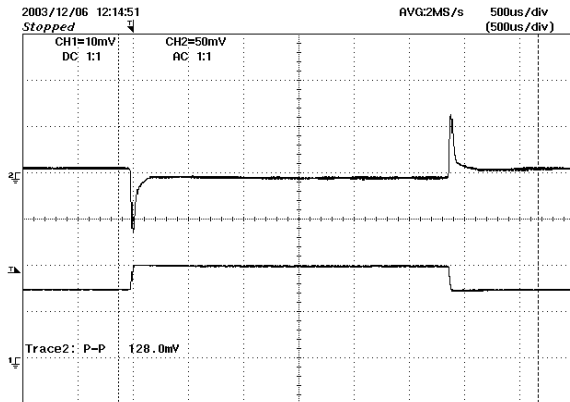

Figure 14 – Transient Response, 115 VAC, 75-100-75% Load Step on 5 V Output, 500 μ s / div. Top: 5 V Output, 50 mV / div. Bottom: 5 V Load current, 1 A / div

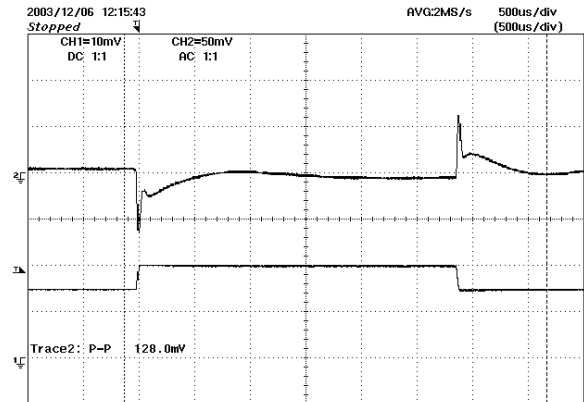

Figure 15 – Transient Response, 230 VAC, 75-100-75% Load Step on 5 V Output, 500 μ s / div. Top: 5 V Output, 50 mV / div. Bottom: Load Current, 1A / div.

10.4 Overvoltage Protection

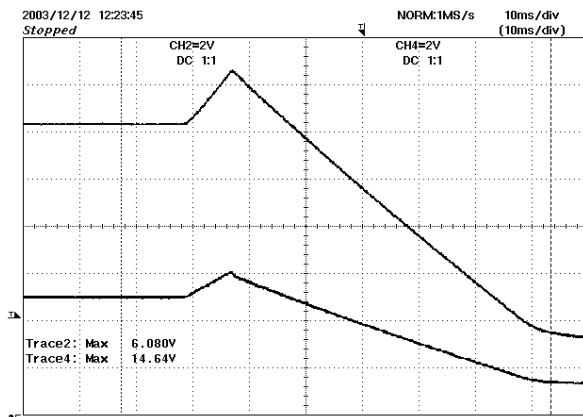

Figure 16 – Overvoltage Protection Waveforms with R15 shorted, 115 VAC Input, 10 msec/div Top Trace: 12 V output, 2 V / div Bottom Trace: 5 V Output, 2 V / div



11 Output Ripple

11.1 Ripple Measurement Technique

For DC output ripple measurements, a modified oscilloscope test probe must be utilized in order to reduce spurious signals due to pickup. Details of the probe modification are provided in Figure 17 and Figure 18.

The 5125BA probe adapter is affixed with two capacitors tied in parallel across the probe tip. The capacitors include one (1) 0.1 $\mu\text{F}/50\text{ V}$ ceramic type and one (1) 1.0 $\mu\text{F}/50\text{ V}$ aluminum electrolytic. **The aluminum electrolytic type capacitor is polarized, so proper polarity across DC outputs must be maintained (see below).**

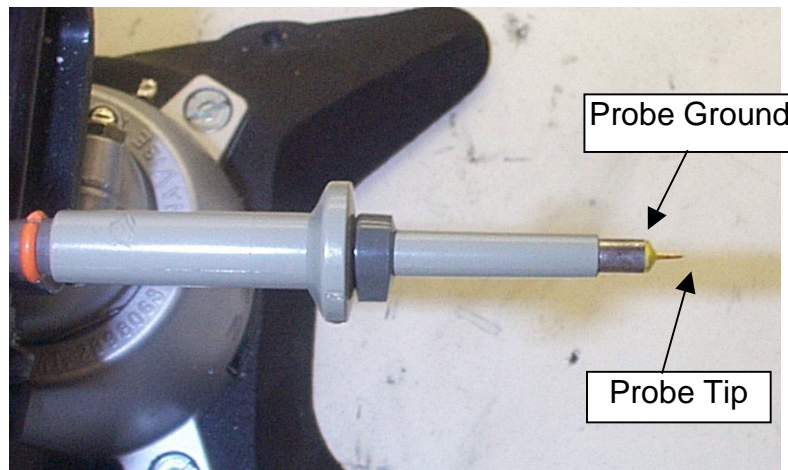

Figure 17 – Oscilloscope Probe Prepared for Ripple Measurement. (End Cap and Ground Lead Removed)

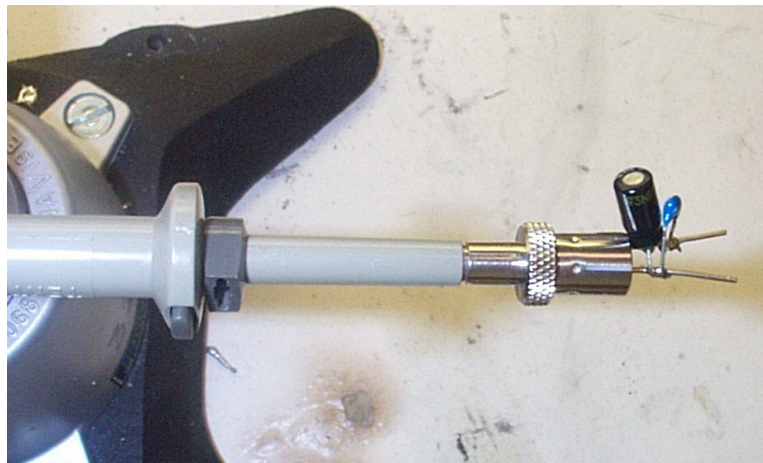

Figure 18 – Oscilloscope Probe with Probe Master 5125BA BNC Adapter. (Modified with wires for probe ground for ripple measurement, and two parallel decoupling capacitors added)

11.2 Measurement Results

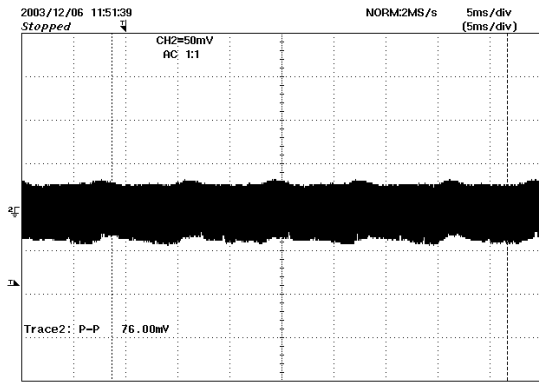

Figure 19 – 5 V Ripple, 90 VAC, Full Load.
5 ms, 50 mV / div

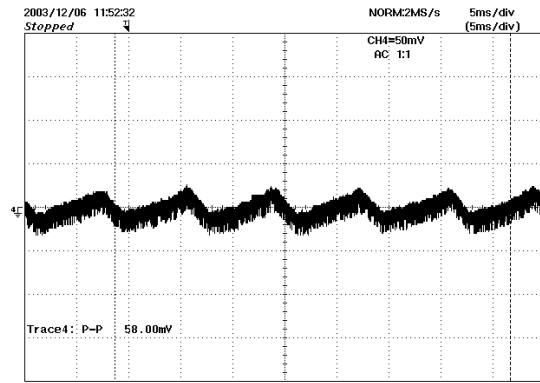

Figure 20 – 12 V Ripple, 90 VAC, Full Load.
5 ms, 50 mV / div.

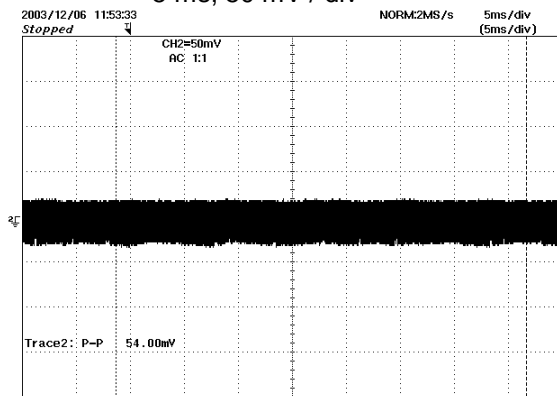

Figure 21 – 5 V Ripple, 115 VAC, Full Load.
5 ms, 50 mV / div.

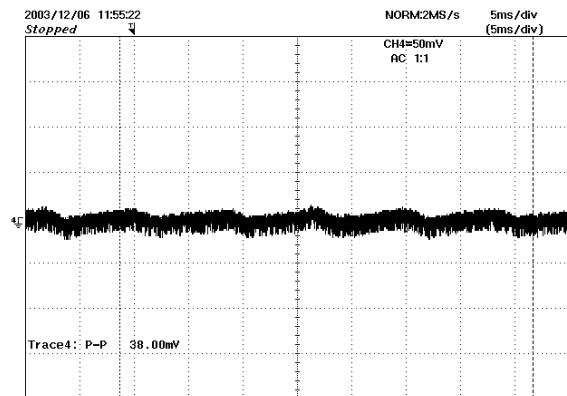

Figure 22 – 12 V Ripple, Full Load. 5ms, 50 mV /div

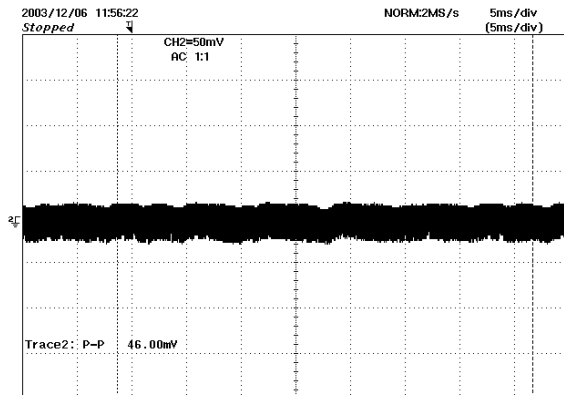

Figure 23 – 5V Ripple, 230 VAC, Full Load.
5 ms, 50 mV /div.

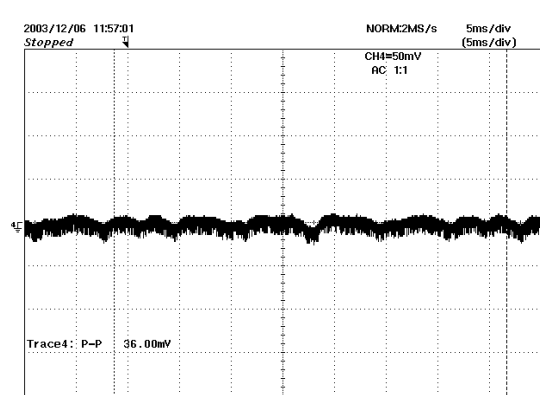
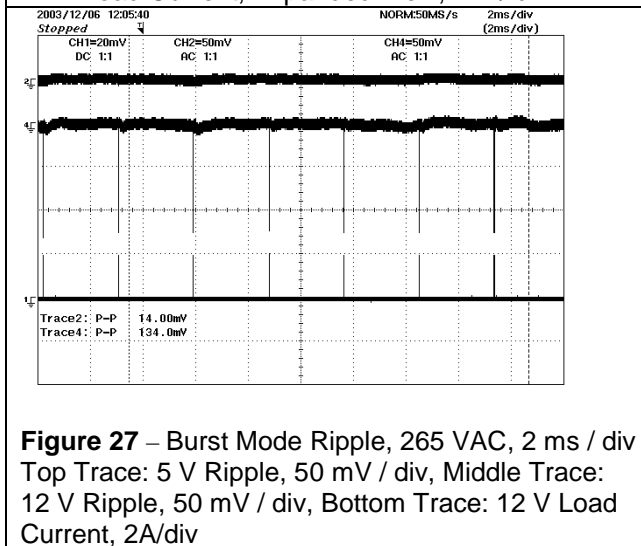
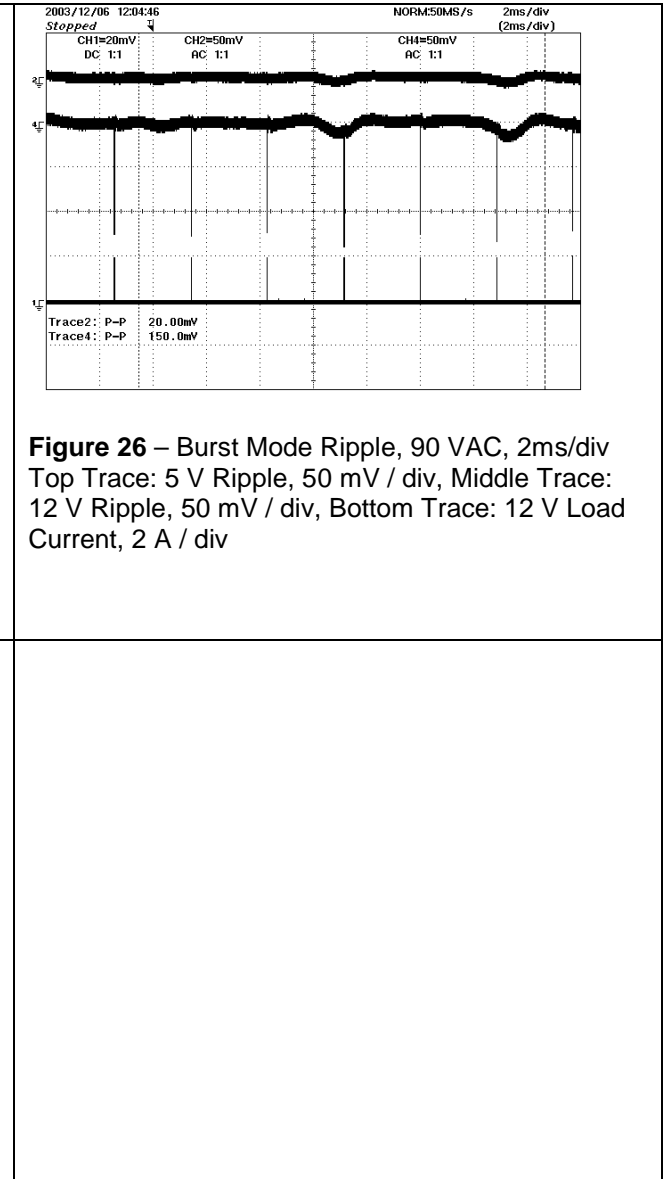
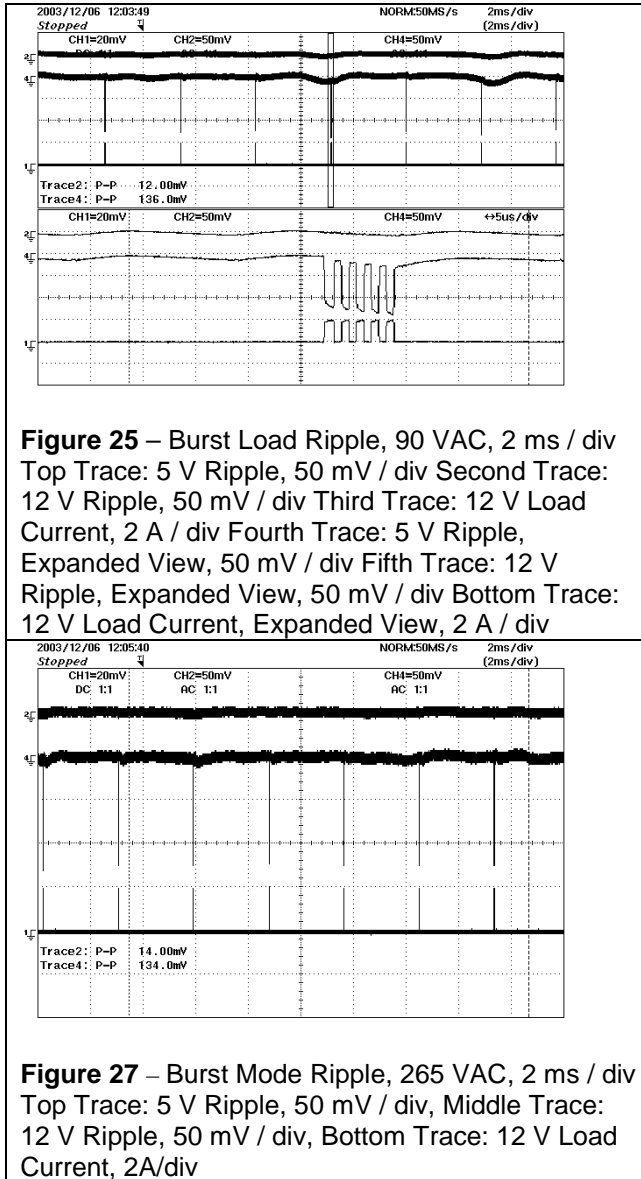

Figure 24 – 12V Ripple, 230 VAC, Full Load.
5 ms, 50 mV /div.



11.3 Ripple with 12 V Burst Load



The three figures above (Figures 25-27) show the effects of a 12 V burst load on the 5 V and 12 V output ripple. The 12 V load was switched from 0 A to 2 A using a MOSFET switch and resistive load. The load switching frequency was ~770 kHz, with a burst of 5 switching cycles repeated at a rate of one burst every 4 milliseconds.

12 Gain-Phase Measurements

12.1 115 VAC Maximum Load

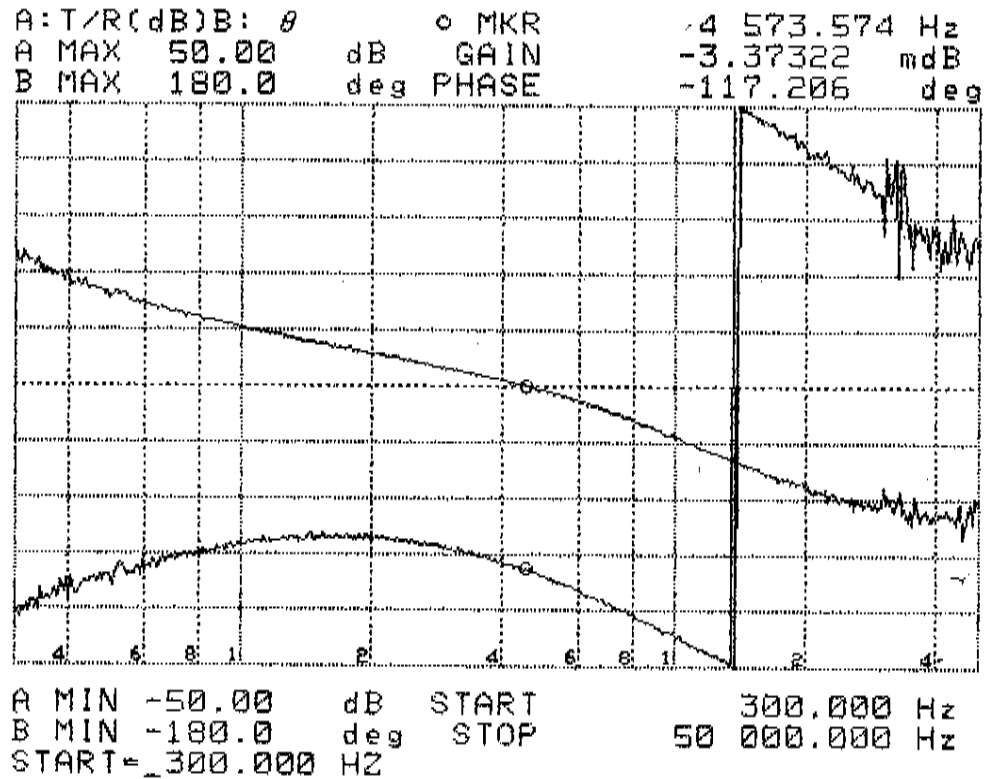

Figure 28 – Gain-Phase Plot, 115 VAC, Maximum Steady State Load
 Vertical Scale: Gain = 50 dB/div, Phase = 100 °/div.
 Crossover Frequency = 4.57 kHz Phase Margin = 62.8°



12.2 230 VAC Maximum Load

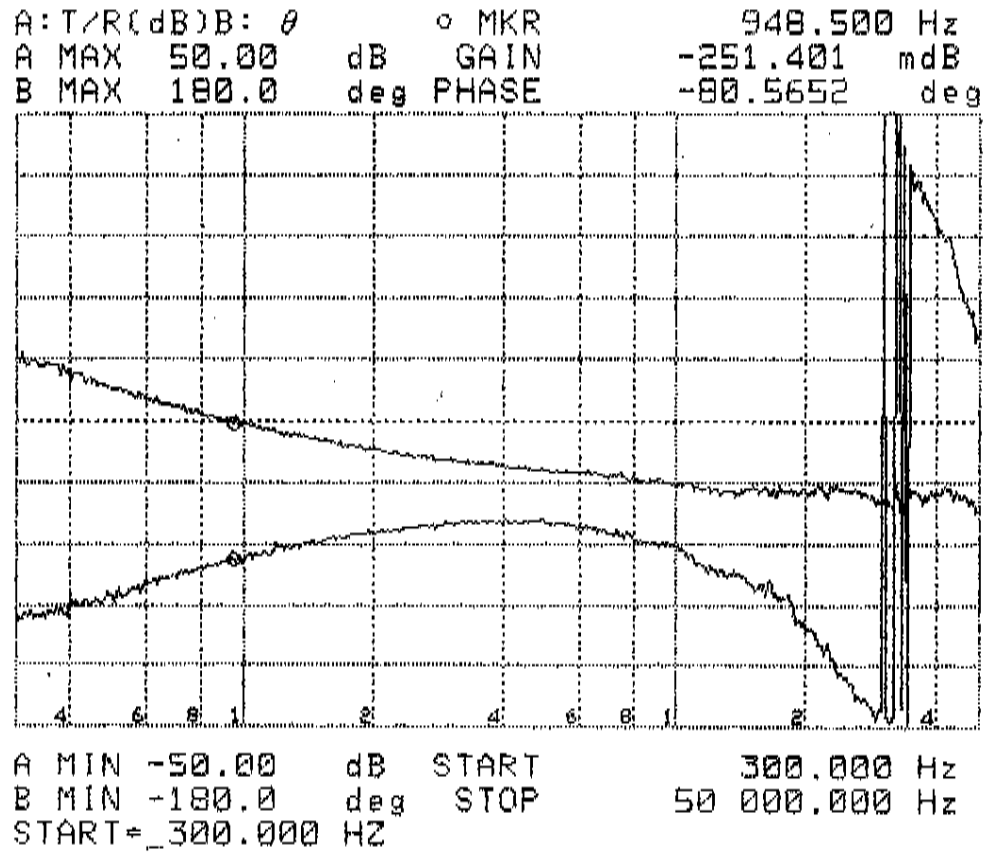

Figure 29 – Gain-Phase Plot, 230 VAC, Maximum Steady State Load
Vertical Scale: Gain = 50 dB/div, Phase = 100 °/div.
Crossover Frequency = 948 Hz, Phase Margin = 99.4°



13 Line Transient Testing

The power supply was tested for 1.2/50 μ sec common mode and differential mode line surge at 230 VAC, full load. The supply was mounted on a metal plate, and the output was monitored with an LED to detect any output interruption. The power supply was deemed to pass a test if it withstood the surge with no output interruption.

Differential Mode Surge, 2 ohm generator impedance, 10 strikes each setting at 30 sec intervals			
Surge Voltage	0° Phase Angle	90° Phase Angle	270° Phase Angle
+3kV	Pass	Pass	Pass
-3kV	Pass	Pass	Pass

Common Mode Surge, 12 ohm generator impedance, 10 strikes each setting at 30 sec intervals			
Surge Voltage	0° Phase Angle	90° Phase Angle	270° Phase Angle
+4kV	Pass	Pass	Pass
-4kV	Pass	Pass	Pass



14 Conducted EMI

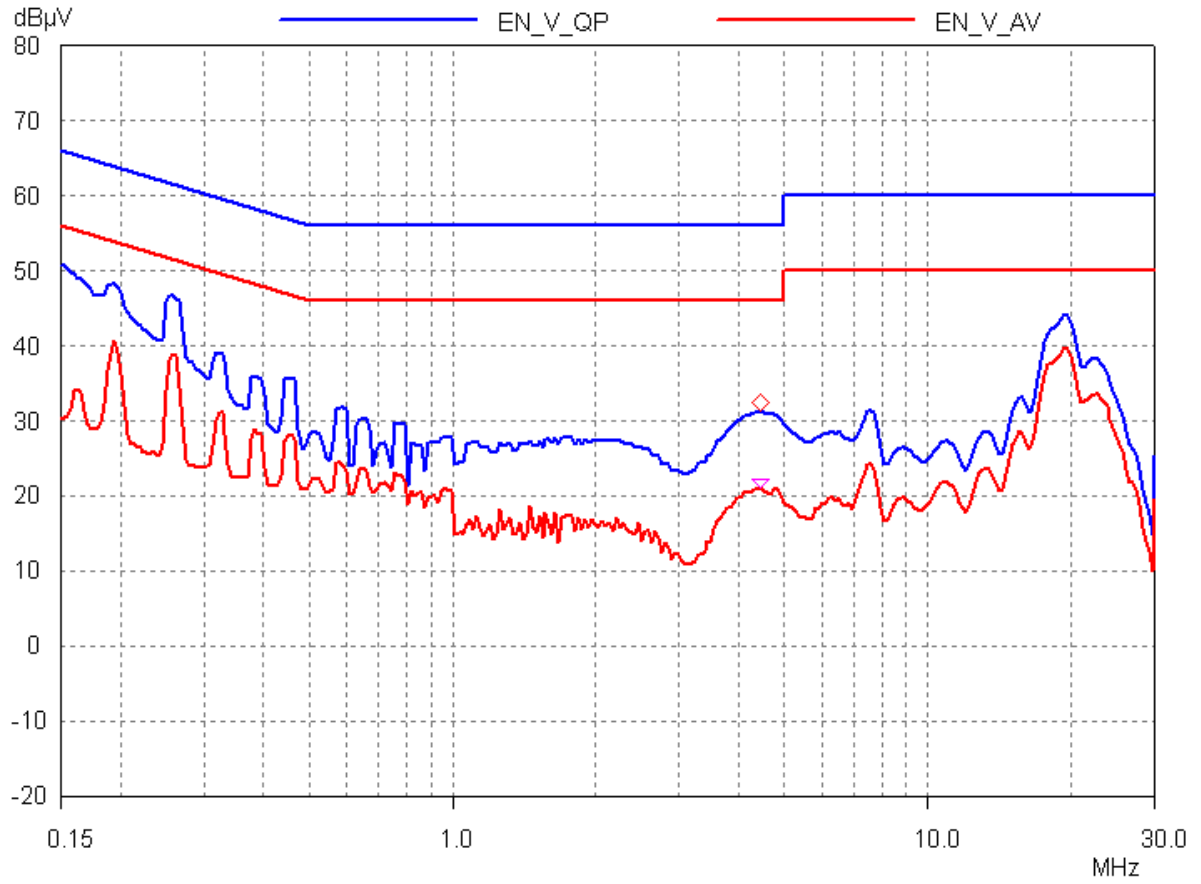

Figure 30 – Conducted EMI, Maximum Steady State Load, 115 VAC, 60 Hz, EN55022 B Limits.



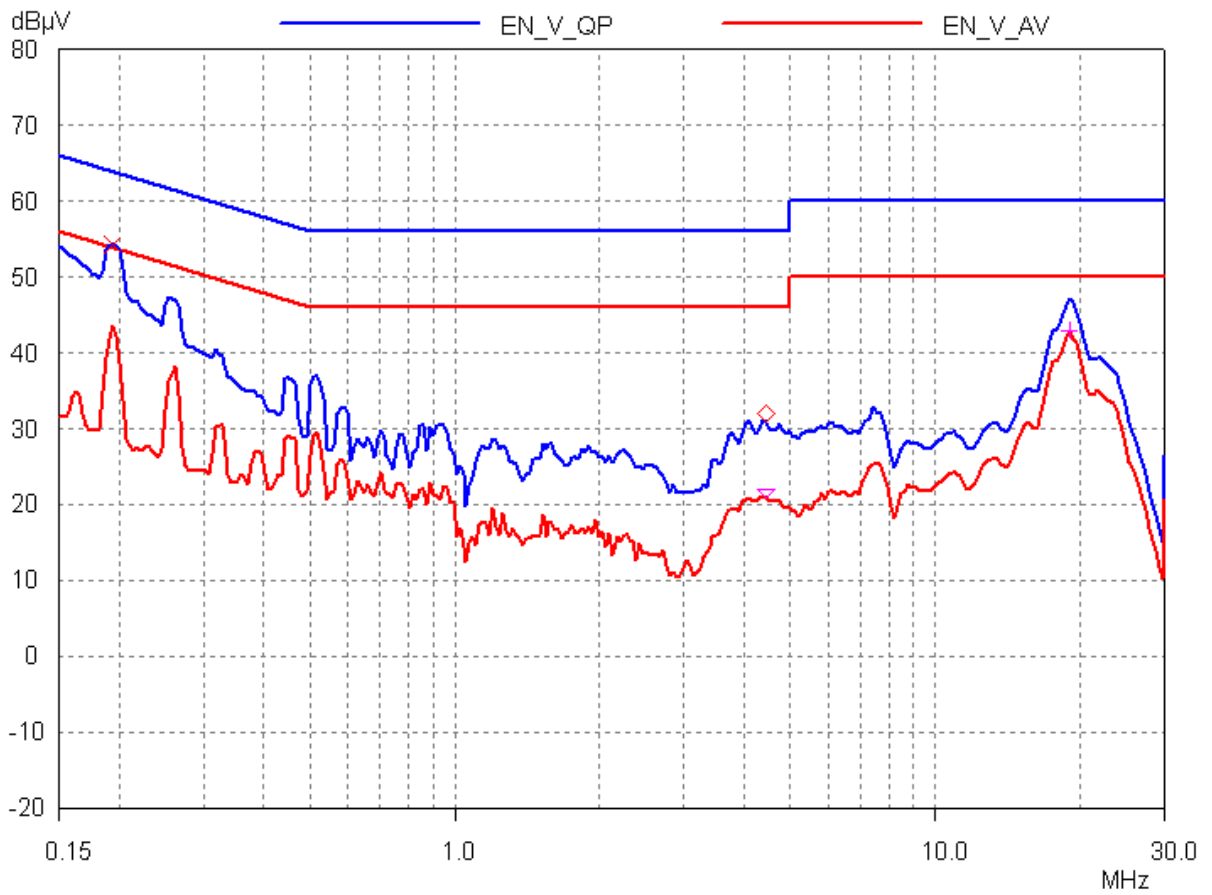

Figure 31 – Conducted EMI, Maximum Steady State Load, 230 VAC, 60 Hz, EN55022 B Limits.

15 Revision History

Date	Author	Revision	Description of Changes	Reviewed
September 12, 2005	RH/ME	1.0	Initial Release	AM / VC



For the latest updates, visit our Web site: www.powerint.com

Power Integrations may make changes to its products at any time. Power Integrations has no liability arising from your use of any information, device or circuit described herein nor does it convey any license under its patent rights or the rights of others. POWER INTEGRATIONS MAKES NO WARRANTIES HEREIN AND SPECIFICALLY DISCLAIMS ALL WARRANTIES INCLUDING, WITHOUT LIMITATION, THE IMPLIED WARRANTIES OF MERCHANTABILITY, FITNESS FOR A PARTICULAR PURPOSE, AND NON-INFRINGEMENT OF THIRD PARTY RIGHTS.

PATENT INFORMATION

The products and applications illustrated herein (including circuits external to the products and transformer construction) may be covered by one or more U.S. and foreign patents or potentially by pending U.S. and foreign patent applications assigned to Power Integrations. A complete list of Power Integrations' patents may be found at www.powerint.com.

The PI Logo, **TOPSwitch**, **TinySwitch**, **LinkSwitch**, and **EcoSmart** are registered trademarks of Power Integrations. **PI Expert** and **DPA-Switch** are trademarks of Power Integrations.

© Copyright 2004, Power Integrations.

Power Integrations Worldwide Sales Support Locations

WORLD HEADQUARTERS

5245 Hellyer Avenue,
San Jose, CA 95138, USA
Main: +1-408-414-9200
Customer Service:
Phone: +1-408-414-9665
Fax: +1-408-414-9765
e-mail:
usasales@powerint.com

CHINA (SHANGHAI)

Rm 807, Pacheer,
Commercial Centre,
555 Nanjing West Road,
Shanghai, 200041, China
Phone: +86-21-6215-5548
Fax: +86-21-6215-2468
e-mail:
chinasales@powerint.com

CHINA (SHENZHEN)

Rm# 1705, Bao Hua Bldg.
1016 Hua Qiang Bei Lu,
Shenzhen, Guangdong,
518031, China
Phone: +86-755-8367-5143
Fax: +86-755-8377-9610
e-mail:
chinasales@powerint.com

APPLICATIONS HOTLINE

World Wide +1-408-414-9660
ER or EPR template – Rev 3.6 – Single sided

GERMANY

Rueckertstrasse 3,
D-80336, Munich, Germany
Phone: +49-895-527-3910
Fax: +49-895-527-3920
e-mail: eurosales@powerint.com

INDIA (TECHNICAL SUPPORT)

Innovatech
261/A, Ground Floor
7th Main, 17th Cross,
Sadashivanagar
Bangalore, India, 560080
Phone: +91-80-5113-8020
Fax: +91-80-5113-8023
e-mail: indiasales@powerint.com

ITALY

Via Vittorio Veneto 12, Bresso,
Milano,
20091, Italy
Phone: +39-028-928-6001
Fax: +39-028-928-6009
e-mail: eurosales@powerint.com

JAPAN

Keihin-Tatemono 1st Bldg.
12-20 Shin-Yokohama,
2-Chome,
Kohoku-ku, Yokohama-shi,
Kanagawa 222-0033, Japan
Phone: +81-45-471-1021
Fax: +81-45-471-3717
e-mail:
japansales@powerint.com

KOREA

8th Floor, DongSung Bldg.
17-8 Yoido-dong,
Youngdeungpo-gu,
Seoul, 150-874, Korea
Phone: +82-2-782-2840
Fax: +82-2-782-4427
e-mail:
koreasales@powerint.com

SINGAPORE

51 Newton Road,
#15-08/10 Goldhill Plaza,
Singapore, 308900
Phone: +65-6358-2160
Fax: +65-6358-2015
e-mail:
singaporesales@powerint.com

TAIWAN

17F-3, No. 510,
Chung Hsiao E. Rd., Sec. 5,
Taipei, Taiwan 110, R.O.C.
Phone: +886-2-2727-1221
Fax: +886-2-2727-1223
e-mail:
taiwansales@powerint.com

UK (EUROPE & AFRICA HEADQUARTERS)

1st Floor, St. James's House
East Street
Farnham, Surrey GU9 7TJ
United Kingdom
Phone: +44-1252-730-140
Fax: +44-1252-727-689
e-mail: eurosales@powerint.com

