



Design Example Report

Title	<i>2.2W Charger using LNK501P</i>
Specification	Input: 90 - 265 Vac Output: 5.5V / 0.4A
Application	Cell Phone Charger
Author	Power Integrations Applications Department
Document Number	DER-13
Date	February 4, 2004
Revision	1.0

Summary and Features

- Uses an EF12.6 transformer
- No Y1 capacitor
- Meets CISPR-22B
- No optocoupler
- Low component count
- Very low earth leakage current

The products and applications illustrated herein (including circuits external to the products and transformer construction) may be covered by one or more U.S. and foreign patents or potentially by pending U.S. and foreign patent applications assigned to Power Integrations. A complete list of Power Integrations' patents may be found at www.powerint.com.

Table Of Contents

1	Introduction.....	3
2	Power Supply Specification.....	4
3	Schematic.....	5
4	PCB Layout.....	6
5	Bill of Materials.....	7
6	Transformer.....	8
6.1	Transformer Winding.....	8
6.2	Electrical Specifications.....	8
6.3	Transformer Construction.....	9
6.4	Winding Instructions.....	9
6.5	Materials.....	10
6.6	Design Notes.....	10
7	Performance Data.....	11
7.1	Line and Load Regulation.....	11
7.2	Efficiency.....	12
7.3	No-Load Input Power.....	13
7.4	Thermal Measurement of Critical Parts.....	13
8	Waveforms.....	14
8.1	Drain Voltage and Current.....	14
8.2	Output Voltage Start-up Profile.....	15
8.3	Load Transient Response (0.2 A to 0.4 A Load Step).....	16
8.4	Output Ripple Measurement.....	17
8.4.1	Ripple Measurement Technique.....	17
8.4.2	Output Voltage Ripple.....	18
9	EMI Tests.....	19
9.1	CSPR22B at 230 Vac.....	19
9.2	CSPR22B at 115 Vac.....	20
10	Revision History.....	21

Important Notes:

Although this board is designed to satisfy safety isolation requirements, the engineering prototype has not been agency approved. Therefore, all testing should be performed using an isolation transformer to provide the AC input to the prototype board.

Design Reports contain a power supply design specification, schematic, bill of materials, and transformer documentation. Performance data and typical operation characteristics are included. Typically only a single prototype has been built.



1 Introduction

This document is an engineering report giving performance characteristics of a 2.2W charger/adaptor. The supply uses LinkSwitch – an integrated IC combining a 700V high voltage MOSFET, PWM controller, start-up, thermal shutdown, and fault protection circuitry.

This document contains the power supply specification, schematic, bill of materials, transformer documentation, and performance data.



2 Power Supply Specification

Description	Symbol	Min	Typ	Max	Units	Comment
Input						
Voltage	V_{IN}	90		265	Vac	2 Wire- No protective ground
Frequency	f_{LINE}	47	50/60	64	Hz	
No-load Input Power (230Vac)				0.3	W	
Output						
Output Voltage 1	V_{OUT}		5.5		V	see Figure 1
Output Current 1	I_{OUT}		0.4		A	see Figure 1
Continuous Output Power	P_{OUT}		2.2		W	
Efficiency	η		67		%	At full load @ 230V
Operating Temperature	T_{AMB}	-5		50	C	
Conducted EMI	CISP22B/EN55022B with Artificial hand connected to output return					

Table 1 – Power Supply Specification

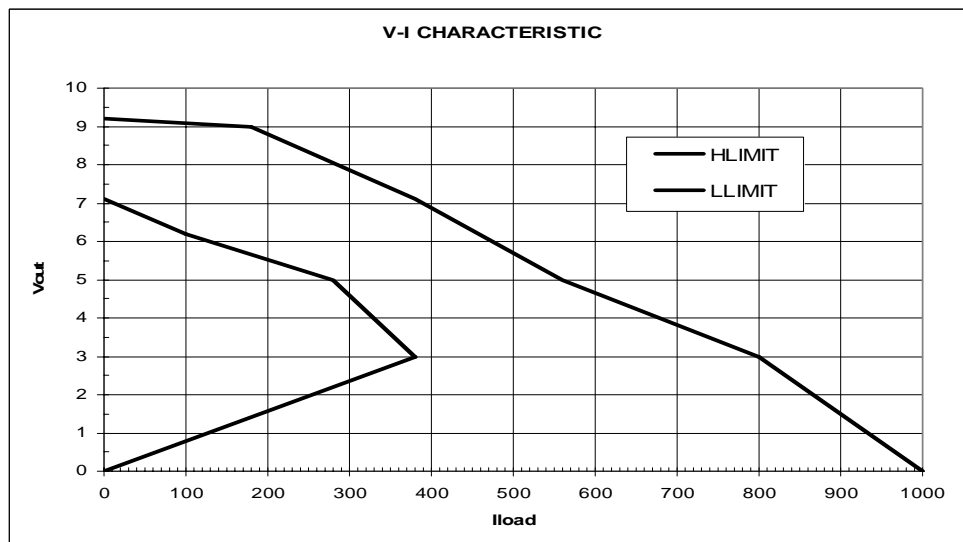

Figure 1: Output V-I Characteristic Envelope Specification



3 Schematic

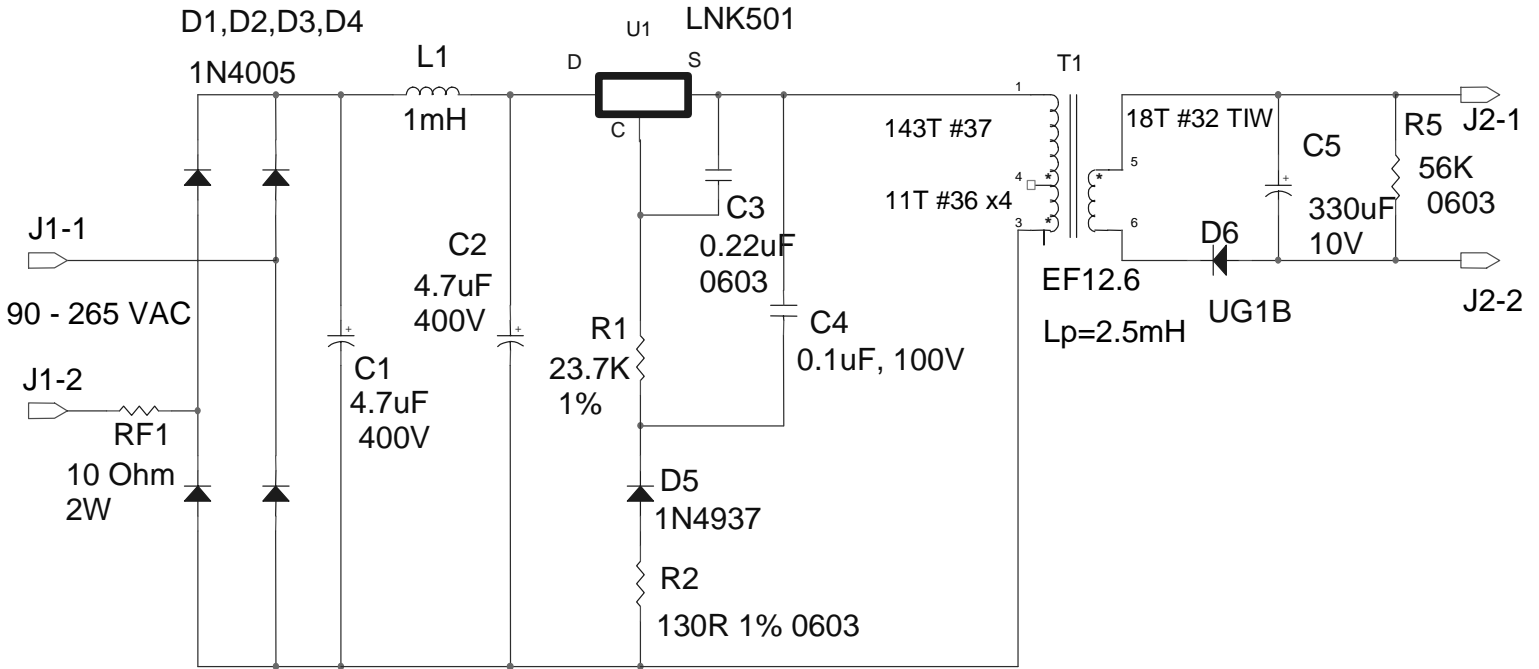

Figure 2: Schematic diagram

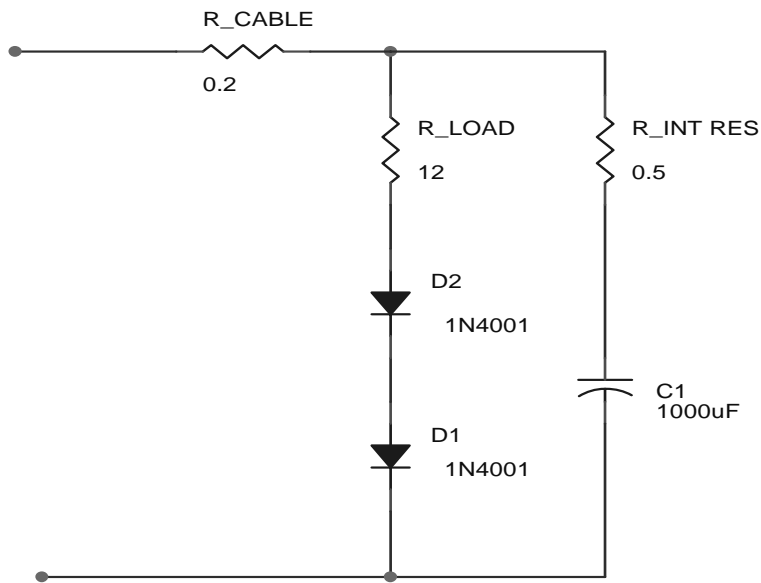

Figure 3: Typical Battery Model

Note: The LinkSwitch is designed for a battery load (see model in Figure 3). If a resistive or electronic load is used, the supply may fail to start up at full load. This is normal. If startup is needed into a resistive load, increase C3 to 1uF.



4 PCB Layout

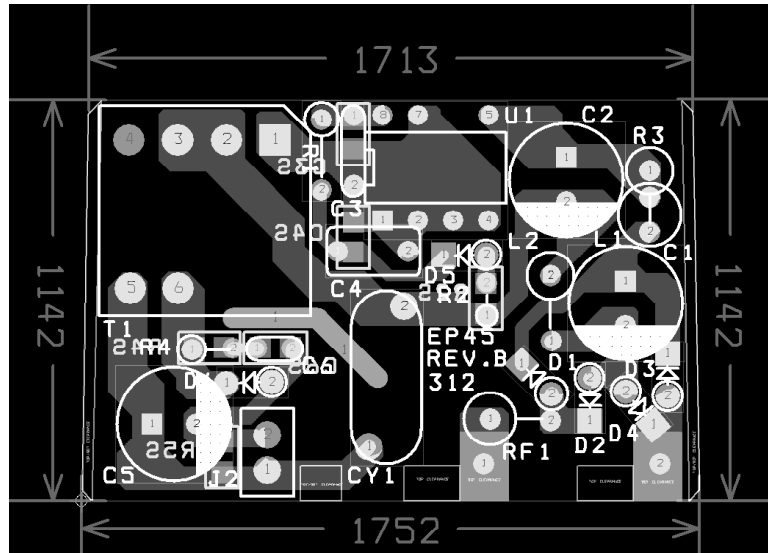

Figure 4: PCB Layout and Dimensions (0.001 inch)



5 Bill of Materials

Item	Quantity	Reference	Part Description
1	2	C1, C2	4.7uF, 400V
2	1	C3	0.22uF, 25V, Y5V, 0603 SMD ceramic
3	1	C4	0.1uF, 100V, X7R ceramic
4	1	C5	330uF, 10V Low ESR E-cap Panasonic FC series
5	4	D1, D2, D3, D4	1N4005, 1A, 600V
6	1	D5	1N4937, 1A, 600V 200nS, Fast Rectifier
7	1	D6	UG1B, 1A, 100V, 15nS Ultra Fast Rectifier
8	1	L1	1mH Inductor- Tokin part #SBCP-47HY102B
9	1	RF1	10 ohm, 2W, Fusible- Vitrohm 253-4 Series
10	1	R2	130 ohms, 1% 0603 SMD resistor
11	1	R1	23.7 ohm 1%; 1/4W resistor
12	1	R5	56 ohm; 0603 SMD resistor
3	1	T1	Custom EF12.6 – Core & Bobbin
14	1	U1	LINK501P- High Voltage IC; Power Integrations, Inc
15	1	PCB	FR1 – 1oz copper DIM: 1.7" x 1.1"; 1.0mm thick



6 Transformer

6.1 Transformer Winding

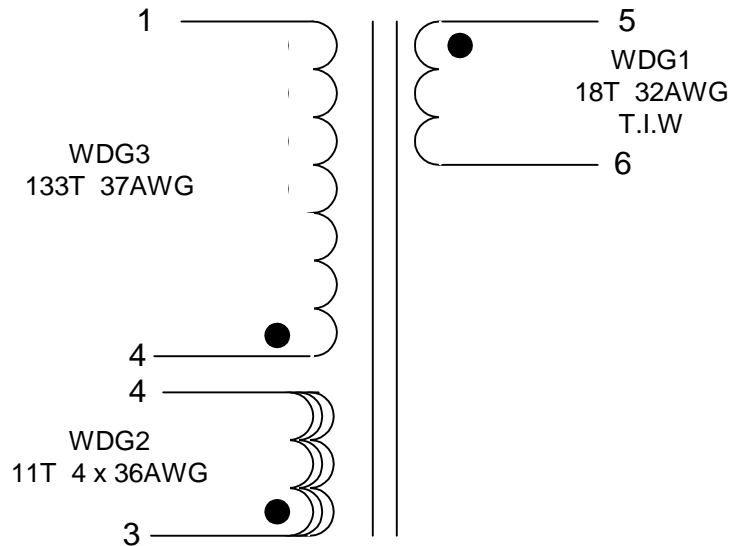

Figure 5– Transformer Schematic EF12.6

6.2 Electrical Specifications

Electrical Strength	60Hz 1minute, from Pins 1-3 to Pins 5-6	3 kV for 1 minute
Primary Inductance (Pin 1 -Pin 3 @ 42KHZ)	All windings open	2450 uH – 2700uH
Primary Leakage Inductance @42KHZ	L_k with pins 5-6 shorted	< 60 uH



6.3 Transformer Construction

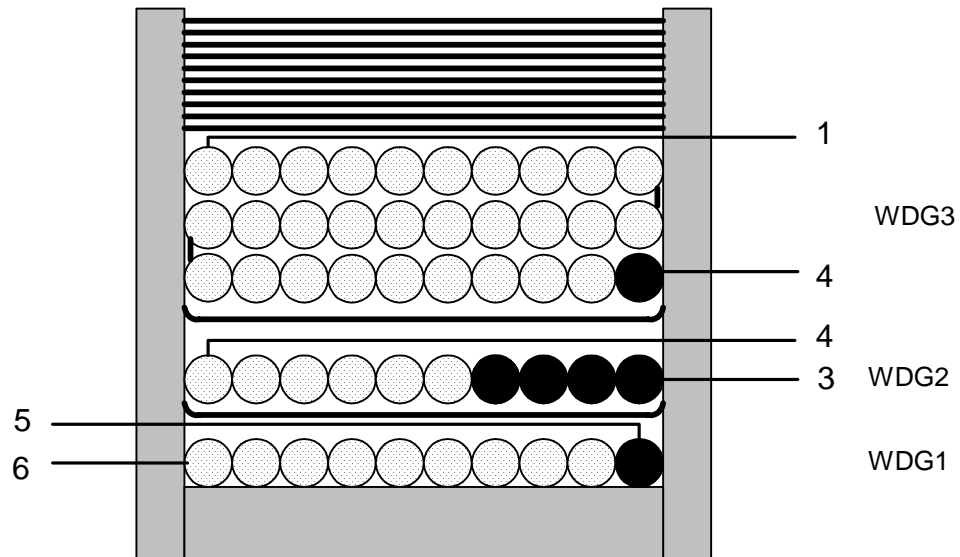

Figure 6– Transformer Cross-section EF12.6

6.4 Winding Instructions

Place the bobbin on the winding machine with pins 1-4 on the right side. Winding should be in forward direction.

WDG1: Secondary Winding	Start at pin 4 temporarily. Wind 18 turns of item 5 from right to left with tight tension. Wind uniformly in a single layer across entire width of bobbin. Finish on pin 6.
Basic Insulation	Secure winding partially using item 6.
WDG1: Secondary Winding	Change the start pin connection of secondary winding from pin 4 to pin 5.
Basic Insulation	Continue winding the tape previously placed for one layer with overlap to secure the end wire of WDG1.
WDG2: Cancellation Winding	Start at pin 3. Wind 11 turns with quadfil of item 3 from right to left with tight tension. Wind uniformly in a single layer across entire width of bobbin. Finish on pin 4.
Basic Insulation	1 layer of tape (Item 6) for insulation.

WDG3: Primary winding 3 layers.	Start at pin 4. Wind 143 turns of item 4 from right to left in three layers across entire width of bobbin. Wind uniformly all layers with tight tension. Finish on pin 1.
Outer Insulation	10 Layer of tape using item 7.
Core Assembly	Assemble and secure core halves with glue.
Shield / Belly Bans	Place outside 1 turn of item 8 with tight contact to winding surface. Connect item 8 to pin 3 by item 3.
Crop unused pins	Remove pin 7 and 8

6.5 Materials

Item	Description
[1]	Core: EF12.6
[2]	Bobbin: BEF12.6- Horizontal 8-PINS
[3]	Magnet Wire: #36 AWG
[4]	Magnet Wire: #37 AWG
[5]	Triple Insulated wire: # 32 AWG
[6]	Tape: 3M 1298 Polyester Film (white) 0.311 x 2 mils
[7]	Tape: 3M 1298 Polyester Film (white) 0.275 x 2 mils
[8]	Copper Foil: 0.01mils x 6mm
[9]	Varnish

6.6 Design Notes

Power Integrations Device	LNK501P
Frequency of Operation	42KHZ
Mode	Discontinuous
Peak current	0.263 A
Reflected Voltage (Secondary to Primary)	47 V
AC Input Voltage Range	90-265VAC



7 Performance Data

Measurements were done at room temperature unless otherwise specified.

7.1 Line and Load Regulation

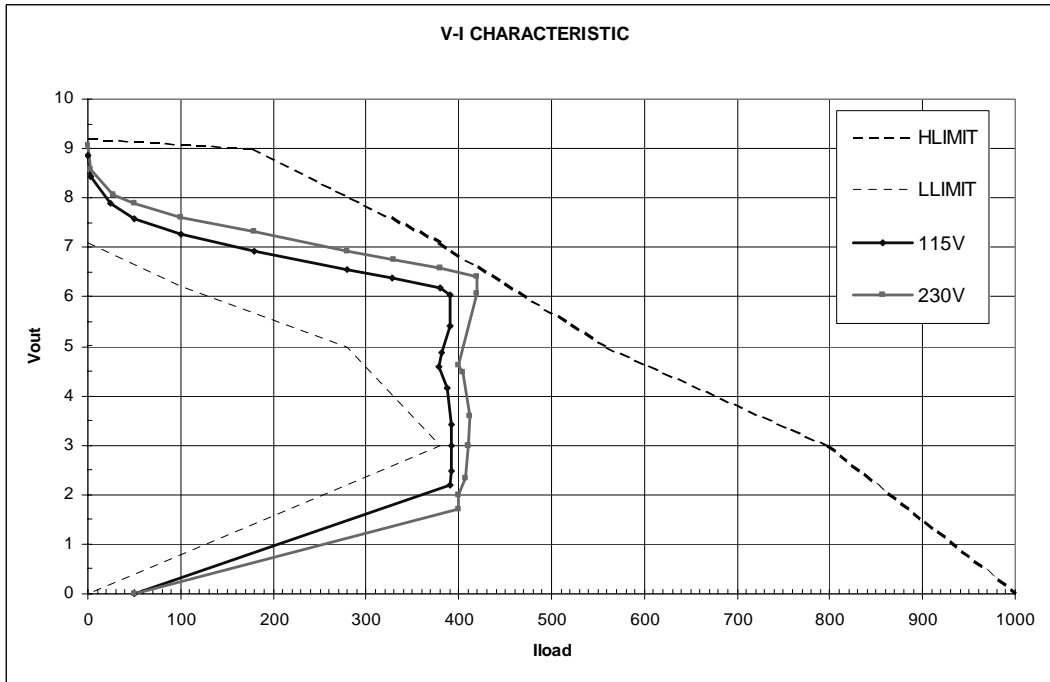

Figure 7– Output VI Characteristic at selected input voltages (115V & 230V)

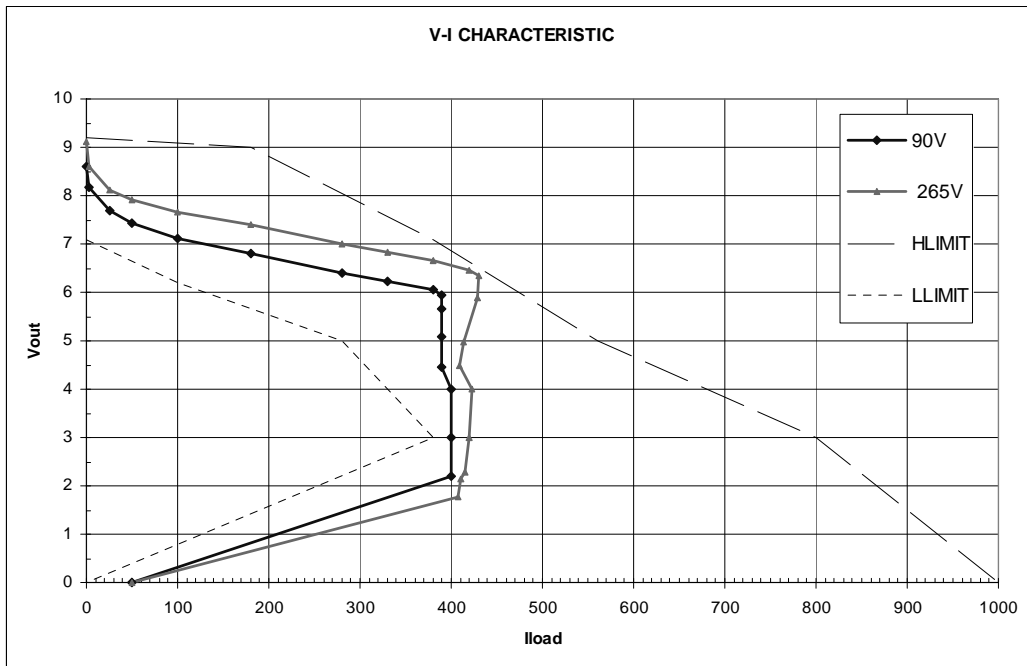

Figure 8– Output VI Characteristic at selected input voltages (90V & 265V)



7.2 Efficiency

The efficiency was measured at max power (~6.4V, 0.4A), using a 16Ω resistor, at room temperature.

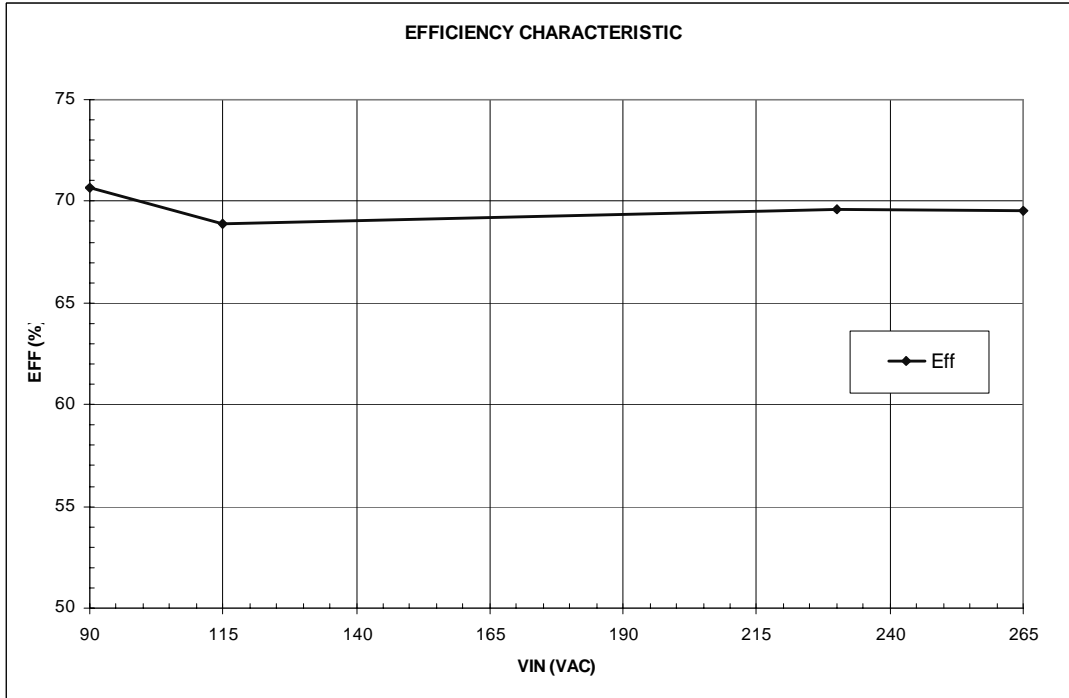

Figure 9– Efficiency vs. Input voltage



7.3 No-Load Input Power

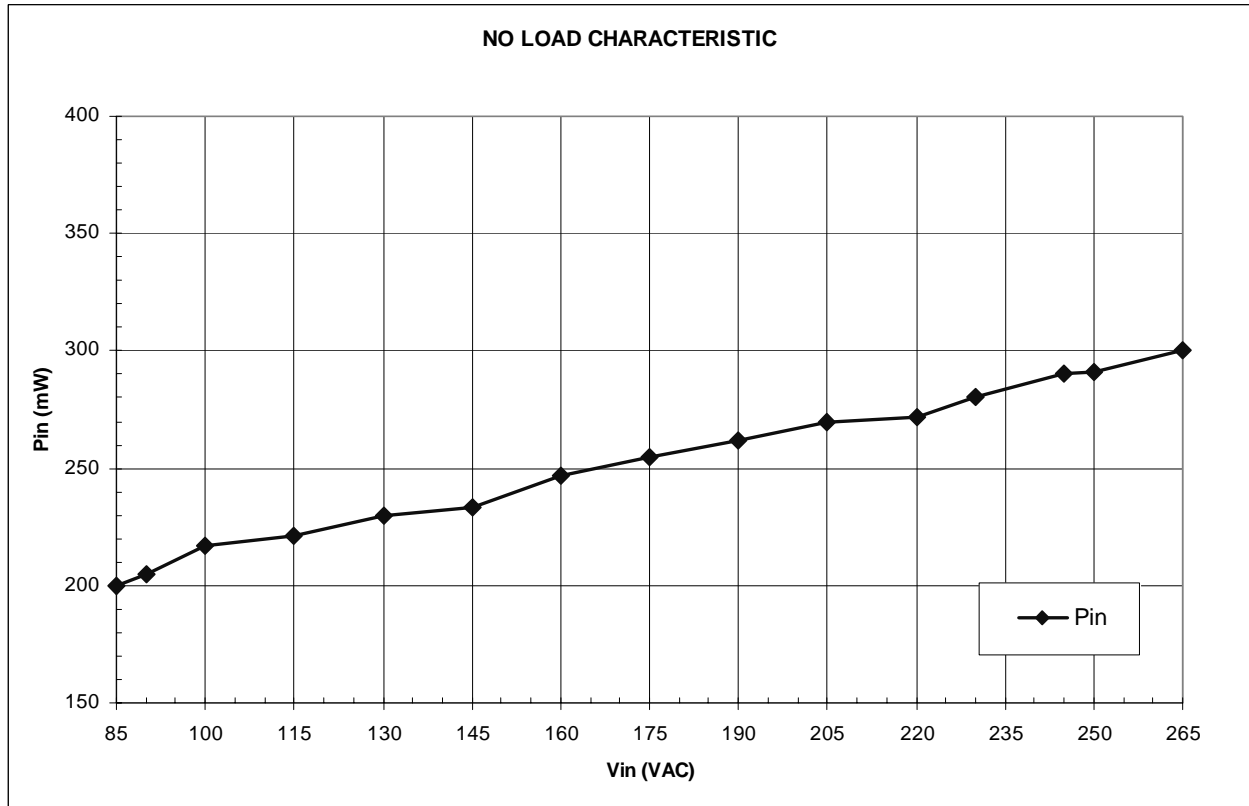

Figure 10– Zero load input power vs. Input line voltage

7.4 Thermal Measurement of Critical Parts

Measurement was done with a 16Ω resistor load, (~6.4 V, 0.4A) inside a plastic enclosure at 25°C with no airflow.

Reference	Description	Temperature
U1	LNK501P	65°C
T1	EF12.6 Transformer	58°C
D6	UG1B	69°C



8 Waveforms

8.1 Drain Voltage and Current

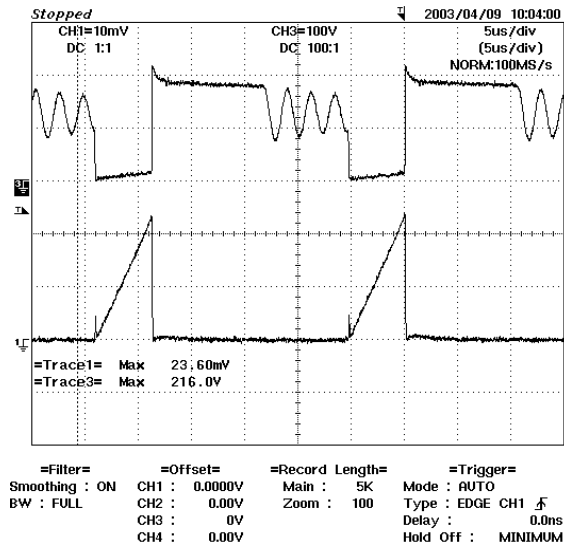

Figure 11– Linkswitch (U1) Vdrain and I drain Waveform. Vin=90Vac, Full load;
CH3: Vdrain (100V/DIV); CH1: Idrain (0.1A/DIV)

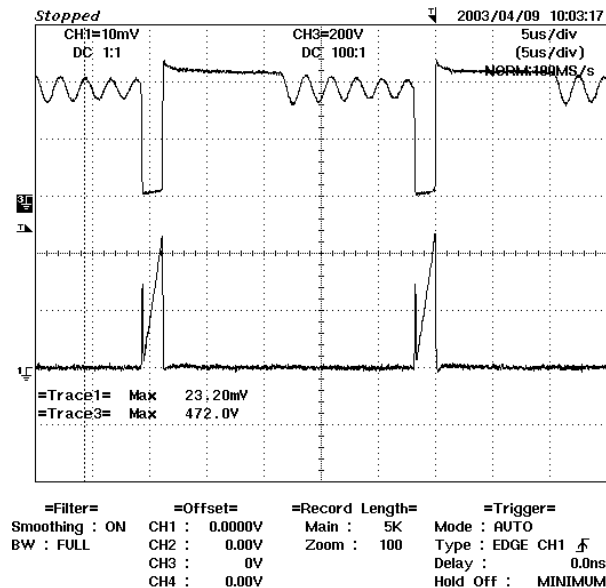

Figure 12– Linkswitch (U1) Vdrain and I drain Waveform. Vin=265Vac, Full load;
CH3: Vdrain (100V/DIV); CH1: Idrain (0.1A/DIV)



8.2 Output Voltage Start-up Profile

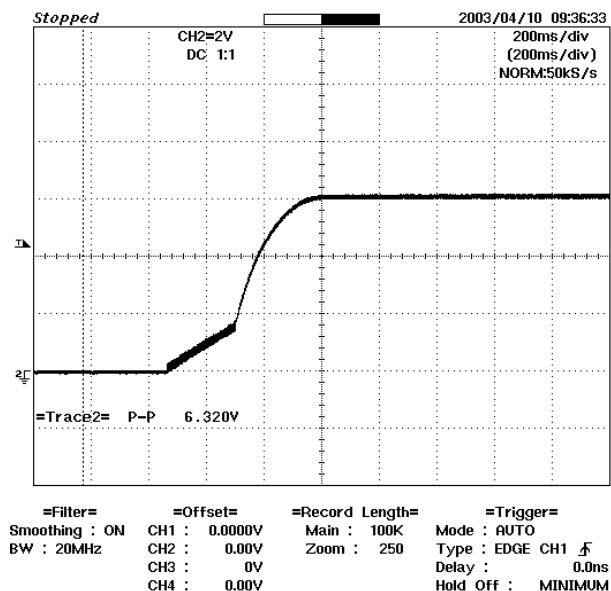

Figure 13– Output voltage at start-up, Battery model, Vin=90 Vac

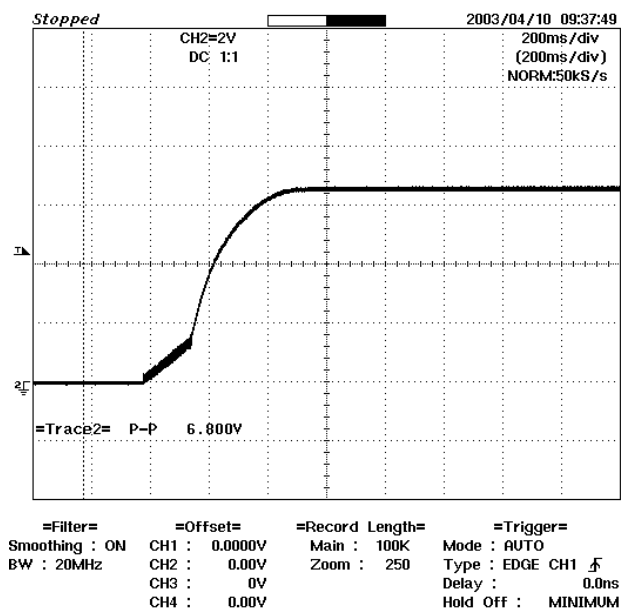

Figure 14– Output voltage at start-up, Battery model, Vin=265 Vac



8.3 Load Transient Response (0.2 A to 0.4 A Load Step)

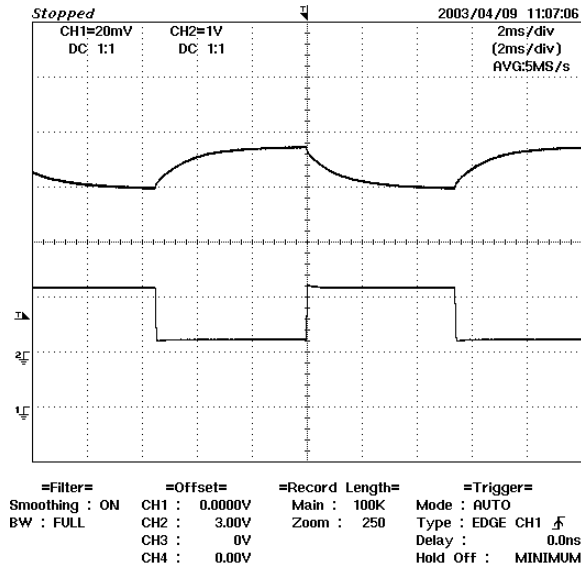

Figure 15– Dynamic Load Transient
 0.2 A to 0.4 A step load at Vin= 90 Vac
 CH2: Output Voltage (1V/DIV); CH3: Load Current

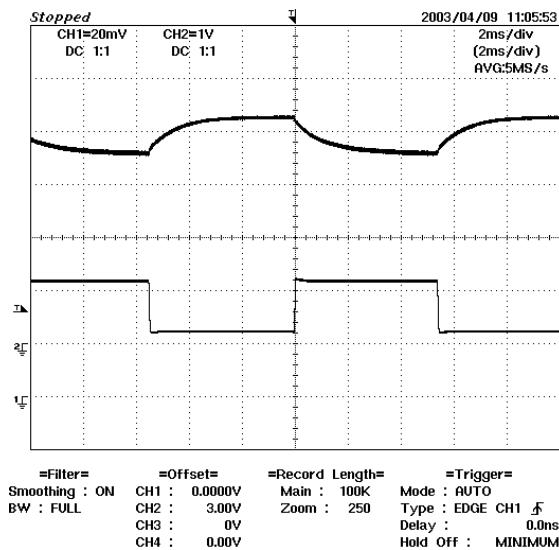

Figure 16– Dynamic Load Transient
 0.2 A to 0.4 A step load at Vin= 265 Vac
 CH2: Output Voltage (1V/DIV); CH3: Load Current



8.4 Output Ripple Measurement

8.4.1 Ripple Measurement Technique

For DC output ripple measurements, a modified oscilloscope test probe must be utilized in order to reduce spurious signals due to pickup. Details of the probe modification are provided in Figure 17 and Figure 18.

The 5125BA probe adapter is affixed with two capacitors tied in parallel across the probe tip. The capacitors include one (1) 0.1 μF /50 V ceramic type and one (1) 1.0 μF /50 V aluminum electrolytic. *The aluminum electrolytic type capacitor is polarized, so proper polarity across DC outputs must be maintained (see below).*

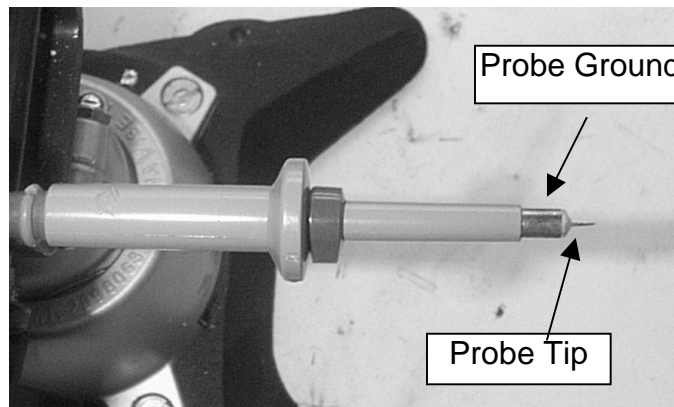

Figure 17 – Oscilloscope Probe Prepared for Ripple Measurement.
(End Cap and Ground Lead Removed)

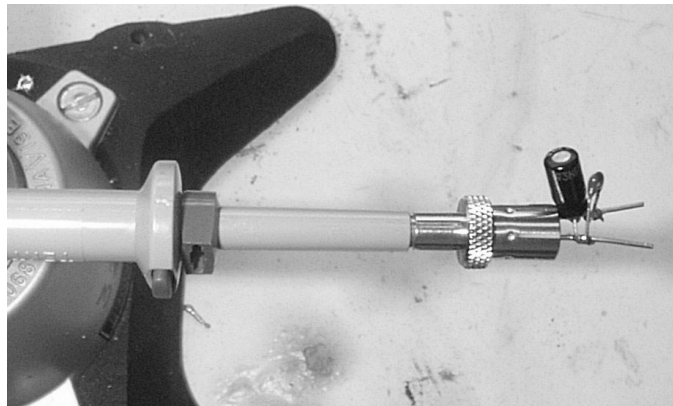

Figure 18 – Oscilloscope Probe with Probe Master 5125BA BNC Adapter

(Modified with wires for probe ground for ripple measurement, and two parallel decoupling capacitors added).

8.4.2 Output Voltage Ripple

Measurements were made using resistive load.

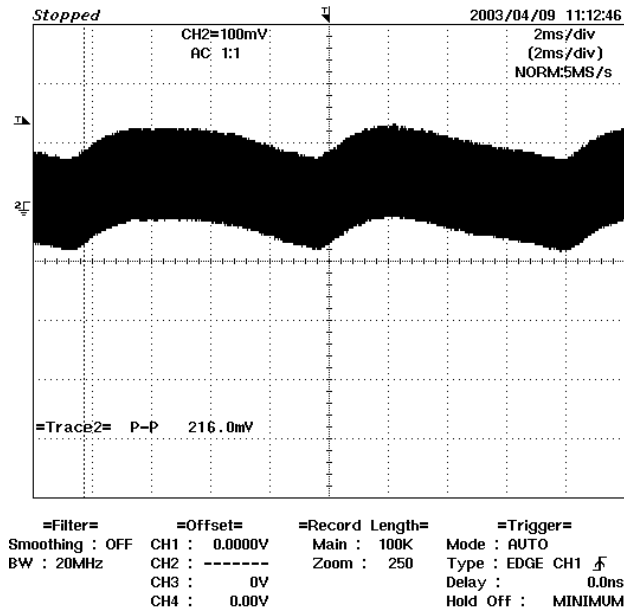

Figure 19: Vin= 90 Vac at full load

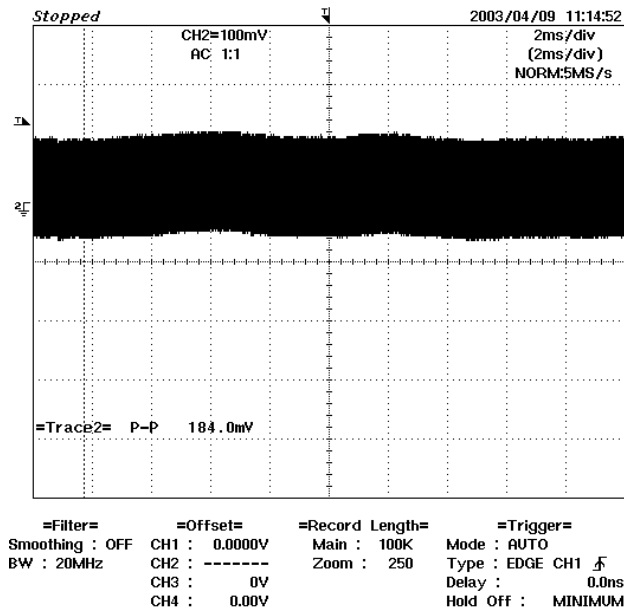

Figure 20: Vin= 265 Vac at full load



9 EMI Tests

The EMI tests were done at 230Vac & 115V (Line & Neutral), with a 20 Ω resistive load.

9.1 CSPR22B at 230 Vac

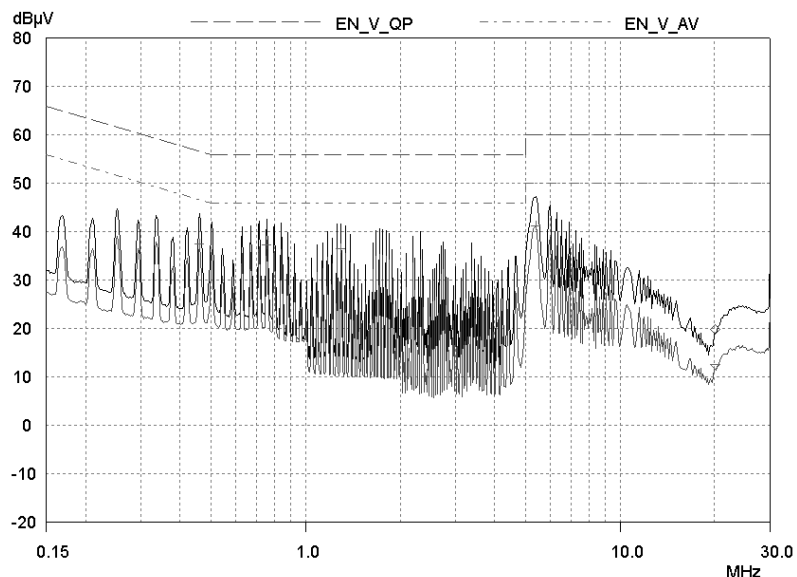

Figure 21 – Conducted EMI, V_{in} = 230 Vac, 60 Hz line, CSPR22B Limits, NEUTRAL; Output return connected to Artificial hand

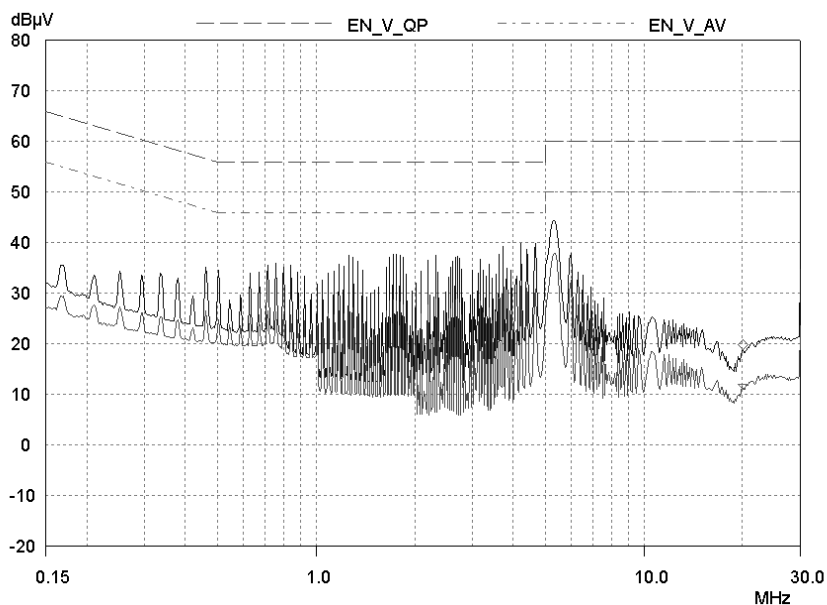

Figure 22 – Conducted EMI, V_{in} = 230 Vac, 60 Hz line, CSPR22B Limits, LINE; Output return floating



9.2 CSPR22B at 115 Vac

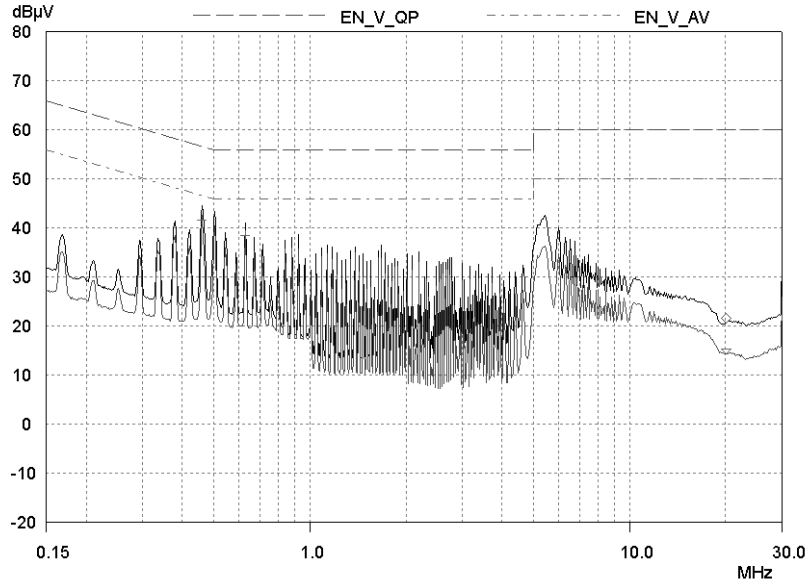

Figure 23— Conducted EMI, Vin= 115V Vac, 60 Hz line, CSPR22B Limits, NEUTRAL, Output return connected to Artificial hand

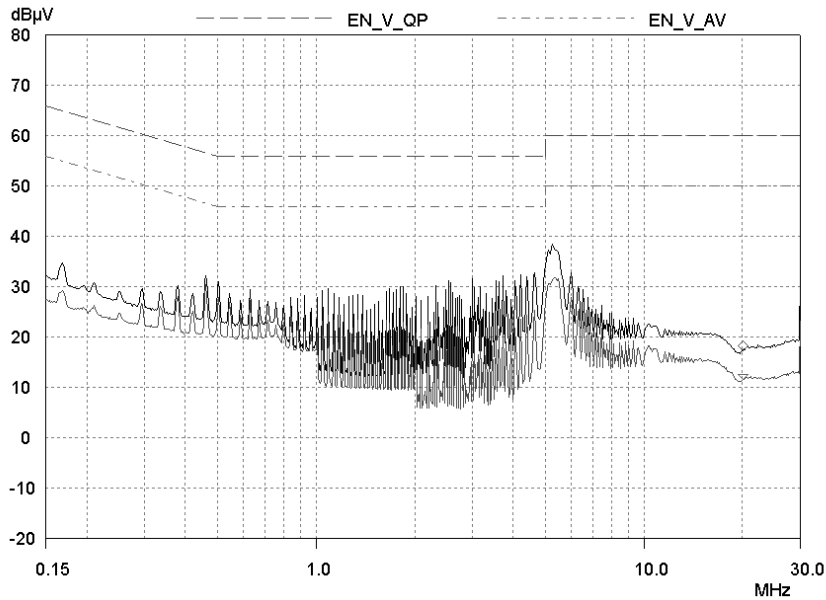

Figure 24 – Conducted EMI, Vin= 115V Vac, 60 Hz line, CSPR22B Limits, LINE, Output return connected to Artificial hand



1-

10 Revision History

Date	Author	Revision	Description & changes	Reviewed
February 4, 2004	ME	1.0	Initial release	AM/VC



Notes



For the latest updates, visit our Web site: www.powerint.com

Power Integrations reserves the right to make changes to its products at any time to improve reliability or manufacturability. Power Integrations does not assume any liability arising from the use of any device or circuit described herein, nor does it convey any license under its patent rights or the rights of others.

The products and applications illustrated herein (including circuits external to the products and transformer construction) may be covered by one or more U.S. and foreign patents or potentially by pending U.S. and foreign patent applications assigned to Power Integrations. A complete list of Power Integrations' patents may be found at www.powerint.com.

The PI Logo, **TOPSwitch**, **TinySwitch**, **LinkSwitch**, and **EcoSmart** are registered trademarks of Power Integrations, Inc. **PI Expert** and **DPA-Switch** are trademarks of Power Integrations, Inc.
© Copyright 2003, Power Integrations, Inc.

**WORLD HEADQUARTERS
NORTH AMERICA - WEST**
Power Integrations, Inc.
5245 Hellyer Avenue
San Jose, CA 95138 USA.
Main: +1•408•414•9200
Customer Service:
Phone: +1•408•414•9665
Fax: +1•408•414•9765

**NORTH AMERICA - EAST
& SOUTH AMERICA**
Power Integrations, Inc.
Eastern Area Sales Office
1343 Canton Road, Suite C1
Marietta, GA 30066 USA
Phone: +1•770•424•5152
Fax: +1•770•424•6567

EUROPE & AFRICA
Power Integrations (Europe) Ltd.
Centennial Court
Easthampstead Road
Bracknell
Berkshire RG12 1YQ,
United Kingdom
Phone: +44•1344•462•301
Fax: +44•1344•311•732

TAIWAN
Power Integrations International
Holdings, Inc.
2F, #508, Chung Hsiao E. Rd.,
Sec. 5,
Taipei 105, Taiwan
Phone: +886•2•2727•1221
Fax: +886•2•2727•1223

CHINA
Power Integrations
International
Holdings, Inc.
Rm# 1705, Bao Hua Bldg.
1016 Hua Qiang Bei Lu
Shenzhen Guangdong,
518031
Phone: +86•755•367•5143
Fax: +86•755•377•9610

KOREA
Power Integrations
International
Holdings, Inc.
Rm# 402, Handuk Building,
649-4 Yeoksam-Dong,
Kangnam-Gu,
Seoul, Korea
Phone: +82•2•568•7520
Fax: +82•2•568•7474

JAPAN
Power Integrations, K.K.
Keihin-Tatemono 1st Bldg.
12-20 Shin-Yokohama 2-
Chome,
Kohoku-ku, Yokohama-shi,
Kanagawa 222, Japan
Phone: +81•45•471•1021
Fax: +81•45•471•3717

INDIA (Technical Support)
Innovatech
#1, 8th Main Road
Vasanthnagar
Bangalore, India 560052
Phone: +91•80•226•6023
Fax: +91•80•228•9727

APPLICATIONS HOTLINE
World Wide +1•408•414•9660

APPLICATIONS FAX
World Wide +1•408•414•9760

