

Design Example Report

Title	<i>65 W 2-Stage PFC Boost and Isolated Flyback Dimmable LED Ballast Using HiperPFS™-4 PFS7624C and LYTSwitch™-6 LYT6068C</i>
Specification	90 VAC – 277 VAC Input; 36 V – 48 V, 1350 mA Output
Application	LED Lighting
Author	Applications Engineering Department
Document Number	DER-733
Date	December 3, 2018
Revision	1.0

Summary and Features

- Industry first AC/DC controller with isolated, safety rated feedback without optocoupler
- High power factor, >0.9 at 90 VAC to 277 VAC, 60 Hz
- Highly energy efficient, >86%
- 3-in-1 Dimming capabilities
 - 0 VDC – 10 VDC analog dimming
 - 10 V PWM signal dimming (frequency range: 300 Hz – 3 kHz)
 - Variable resistance dimming (0 to 100 kΩ)
- Integrated protection and reliability features
 - Output short-circuit protection
 - Line and output OVP
 - Thermal foldback and over-temperature shutdown with hysteretic automatic power recovery
- No damage during line brown-in or brown-out conditions
- Meets IEC 2.5 kV ring wave, 1 kV differential surge
- Meets EN55015 conducted EMI

Power Integrations

5245 Hellyer Avenue, San Jose, CA 95138 USA.
 Tel: +1 408 414 9200 Fax: +1 408 414 9201
www.power.com

PATENT INFORMATION

The products and applications illustrated herein (including transformer construction and circuit's external to the products) may be covered by one or more U.S. and foreign patents, or potentially by pending U.S. and foreign patent applications assigned to Power Integrations. A complete list of Power Integrations' patents may be found at www.power.com. Power Integrations grants its customers a license under certain patent rights as set forth at <https://www.power.com/company/intellectual-property-licensing/>.



Table of Contents

1	Introduction	6
2	Power Supply Specification	8
3	Schematic	9
4	Circuit Description	12
4.1	Input Circuit Description.....	12
4.2	HiperPFS-4 PFC Boost Converter.....	12
4.2.1	Output Feedback	13
4.2.2	Bias Supply Series Regulator.....	13
4.3	Flyback Primary Circuit.....	13
4.4	LYTSwitch-6 Secondary-Side Control.....	14
4.5	3-in-1 Dimming Circuit	14
4.5.1	3-in-1 Dimming Set-up	16
5	PCB Layout	17
6	Bill of Materials	18
6.1	Electricals.....	18
6.2	Mechanicals and Miscellaneous.....	20
7	Flyback Transformer (T3) Specification	21
7.1	Electrical Diagram.....	21
7.2	Electrical Specifications	21
7.3	Material List	21
7.4	Transformer Build Diagram	22
7.5	Transformer Construction.....	22
7.6	Transformer Winding Illustrations.....	23
8	PFC Inductor (T2) Specifications	29
8.1	Electrical Diagram.....	29
8.2	Electrical Specifications	29
8.3	Material List	29
8.4	Inductor Build Diagram	30
8.5	Inductor Construction	30
8.6	Inductor Winding Illustrations	31
9	Design Spreadsheet.....	33
9.1	HiperPFS-4 Spreadsheet.....	33
9.2	LYTSwitch-6 Spreadsheet.....	38
10	Performance Data	41
10.1	Output Current Regulation	41
10.2	System Efficiency.....	42
10.3	Power Factor	43
10.4	%ATHD	44
10.5	Individual Harmonics Content at Full Load.....	45
10.5.1	Low Line	45
10.5.2	High Line.....	46
10.6	No-Load Input Power	47
10.7	CV/CC Curve (for Non-Dimming Applications Only)	48

10.8	Dimming Performance: 3-in-1 Dimming	49
10.8.1	Variable Supply Dimming.....	49
10.8.2	Variable Resistor Dimming	50
10.8.3	Variable Duty PWM Dimming	51
11	Test Data	52
11.1	36 V Output	52
11.2	42 V Output	52
11.3	48 V Output	53
11.4	Test Data at No-Load.....	53
11.5	Individual Harmonic Content at 115 VAC 60 Hz and Full Load.....	54
11.6	Individual Harmonic Content at 230 VAC 50 Hz and Full Load.....	55
12	Thermal Performance.....	56
12.1	Thermal Measurements at Ambient Room Temperature	56
12.2	Thermal Results.....	57
12.3	90 VAC.....	58
12.4	120 VAC.....	59
12.5	230 VAC.....	60
12.6	277 VAC.....	61
12.7	Thermal Performance at High Ambient Temperature.....	62
13	Waveforms	65
13.1	Input Voltage and Input Current at Full Load.....	65
13.2	Start-up Profile at Full Load	66
13.3	Turn-Off Profile Full Load	67
13.4	HiperPFS-4 Drain Voltage and Current Waveforms at Normal Operation	68
13.5	HiperPFS-4 Drain Voltage and Current Waveforms at Full Load Start-up.....	69
13.6	LYTSwitch-6 Drain Voltage and Current Waveforms at Normal Operation	70
13.7	LYTSwitch-6 Drain Voltage and Current at Full Load Start-up	72
13.8	LYTSwitch-6 Drain Voltage and Current during Output Short-Circuit.....	74
13.8.1	Input Power during Output Short Circuit.....	76
13.9	Brown-In and Brown-Out at 2 V / Minute Rate	76
13.10	AC Cycling Test at 48 V LED Load	77
13.11	AC Cycling Test at 36 V LED Load	78
13.12	Output Current Ripple.....	79
13.12.1	Equipment Used	79
13.12.2	Ripple Ratio and Flicker % Measurement	79
14	Conducted EMI	81
14.1	Test Set-up	81
14.1.1	Equipment and Load Used	81
14.2	EMI Test Result	82
15	Line Surge.....	84
15.1	Differential Surge Test Results.....	84
15.2	Ring Wave Surge Test Results.....	84
16	Revision History	85



Important Note: Although this board is designed to satisfy safety isolation requirements, the engineering prototype has not been agency approved. Therefore, all testing should be performed using an isolation transformer to provide the AC input to the prototype board.



1 Introduction

This engineering report describes a 3-in-1 dimmable isolated flyback LED driver with a boost PFC front-end that is designed to drive an LED voltage string of 48 V at 1350 mA from an input voltage range of 90 VAC to 277 VAC. The boost PFC utilizes a HiperPFS-4 PFS7624C PFC controller with an integrated MOSFET and an external boost diode. This provides the regulated DC input to the isolated flyback LED driver which utilizes the LYT6068C from the LYTSwitch-6 family of devices. The key design goals were high power factor, low harmonic content, high efficiency, and 3-in-1 dimmable from 0% to 100% output current.

This document contains the power supply specification, schematic diagram, bill of materials, transformer documentation, printed circuit board layout, and performance data.

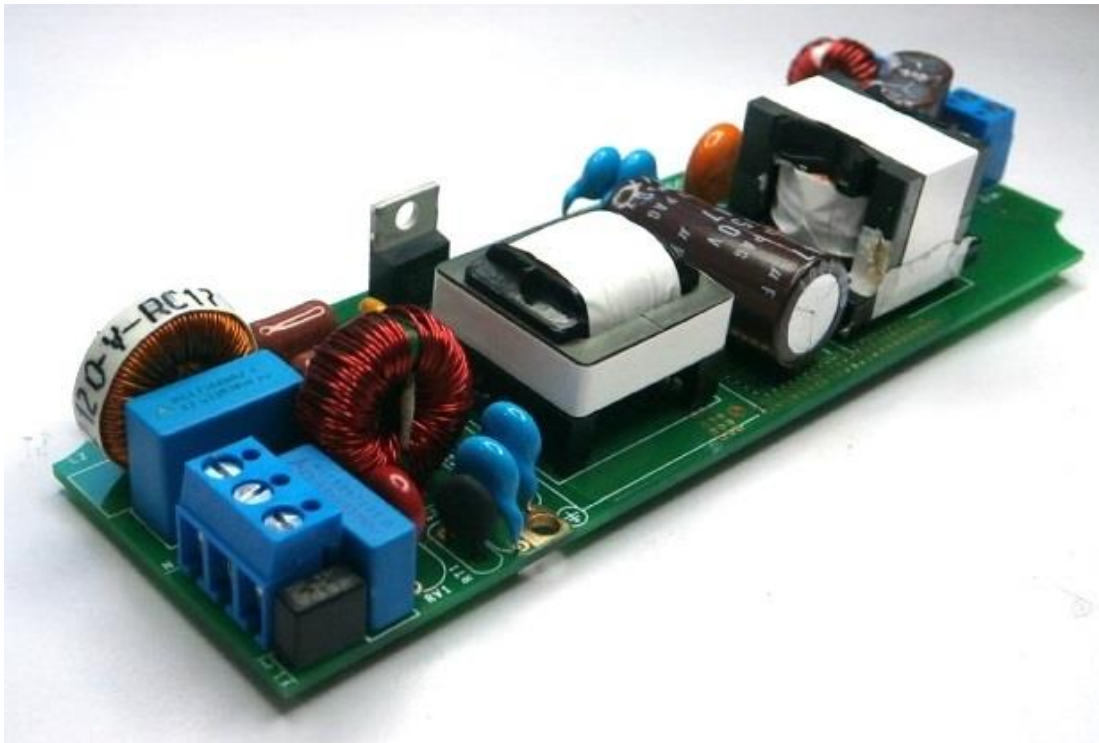

Figure 1 – Populated Circuit Board.



Figure 2 – Populated Circuit Board, Top View.



Figure 3 – Populated Circuit Board, Bottom View.

2 Power Supply Specification

The table below represents the minimum acceptable performance of the design. Actual performance is listed in the results section.

Description	Symbol	Min	Typ	Max	Units	Comment
Input Voltage Frequency	V_{IN} f_{LINE}	90	230 50	277	Vac/Hz	2 Wire – No P.E.
Output Output Voltage Output Current Total Output Power Continuous Output Power	V_{OUT} I_{OUT} P_{OUT}	36 1283	48 1350	1422	V mA W	±5%
Efficiency Full Load Average Efficiency	η		86 >86		% %	At 90 VAC / 60 Hz. 25 °C Ambient Temperature. Meets DOE Level VI.
Environmental Conducted EMI Safety Ring Wave (100 kHz) Differential Mode (L1-L2)			CISPR 15B / EN55015B Isolated 2.5 1		kV kV	
Power Factor		0.9				Measured at 90 VAC / 60 Hz and 277 VAC / 60 Hz.
Ambient Temperature	T_{AMB}			55	°C	Free Air Convection, Sea Level. At 230 VAC Input.

3 Schematic

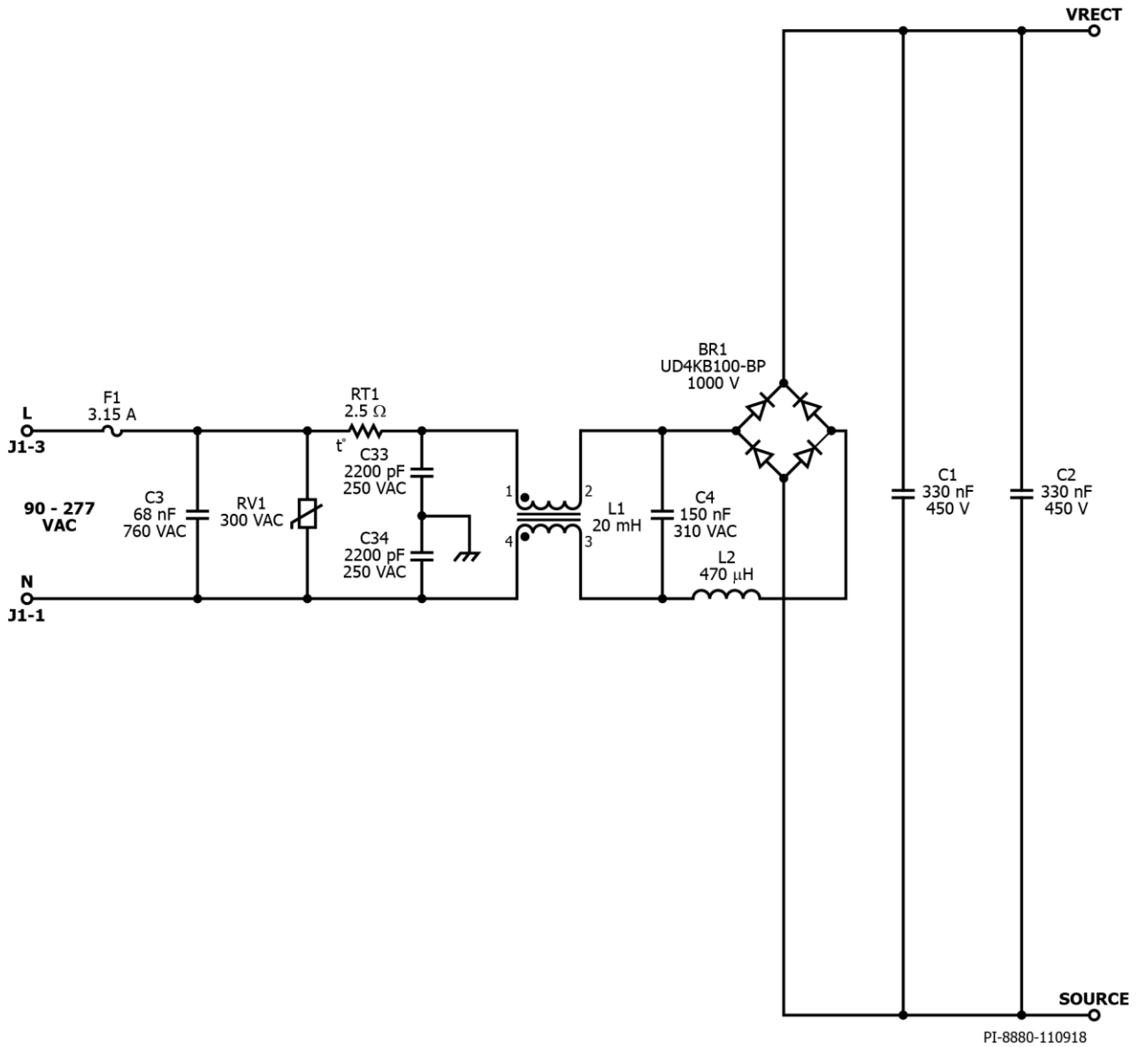

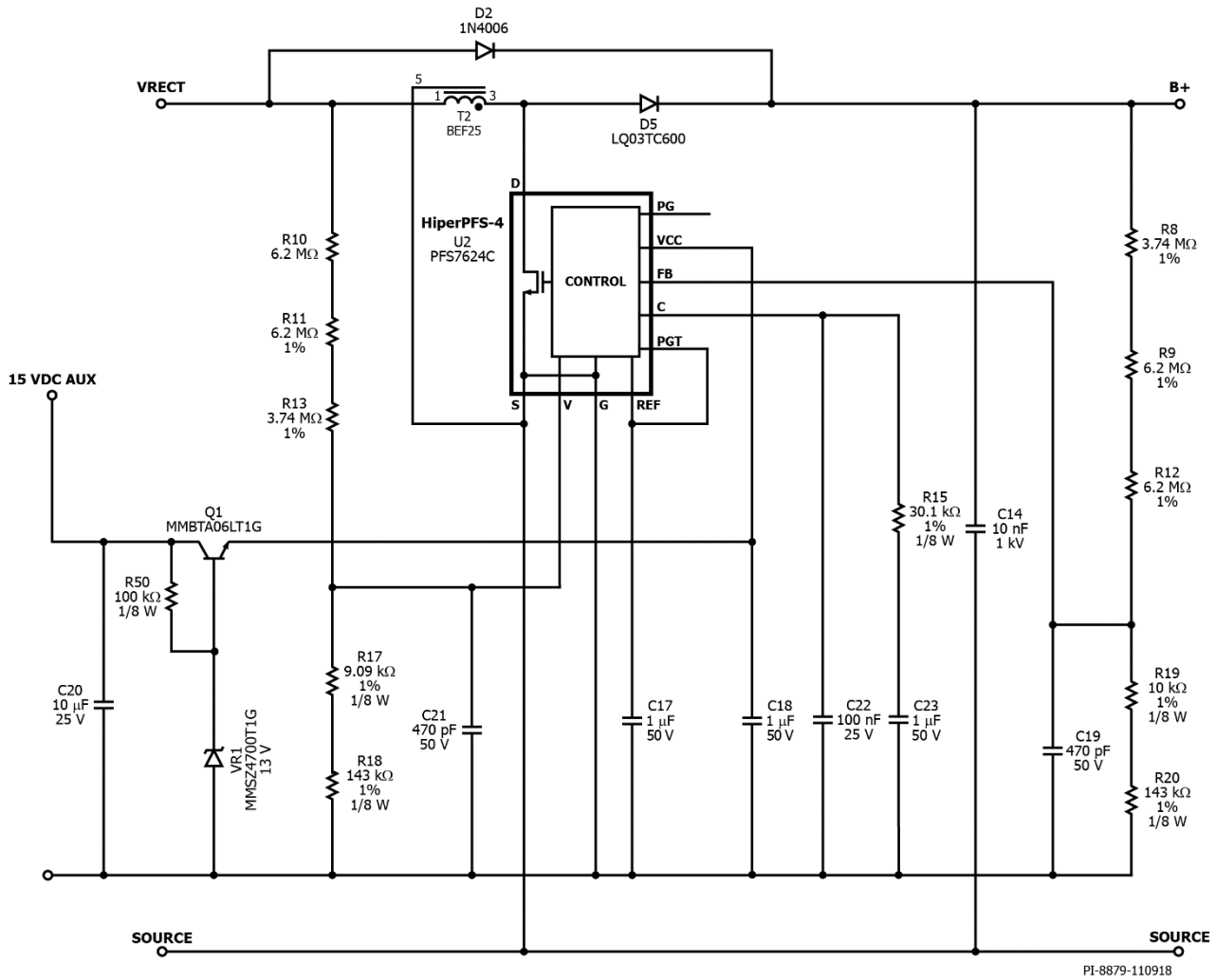

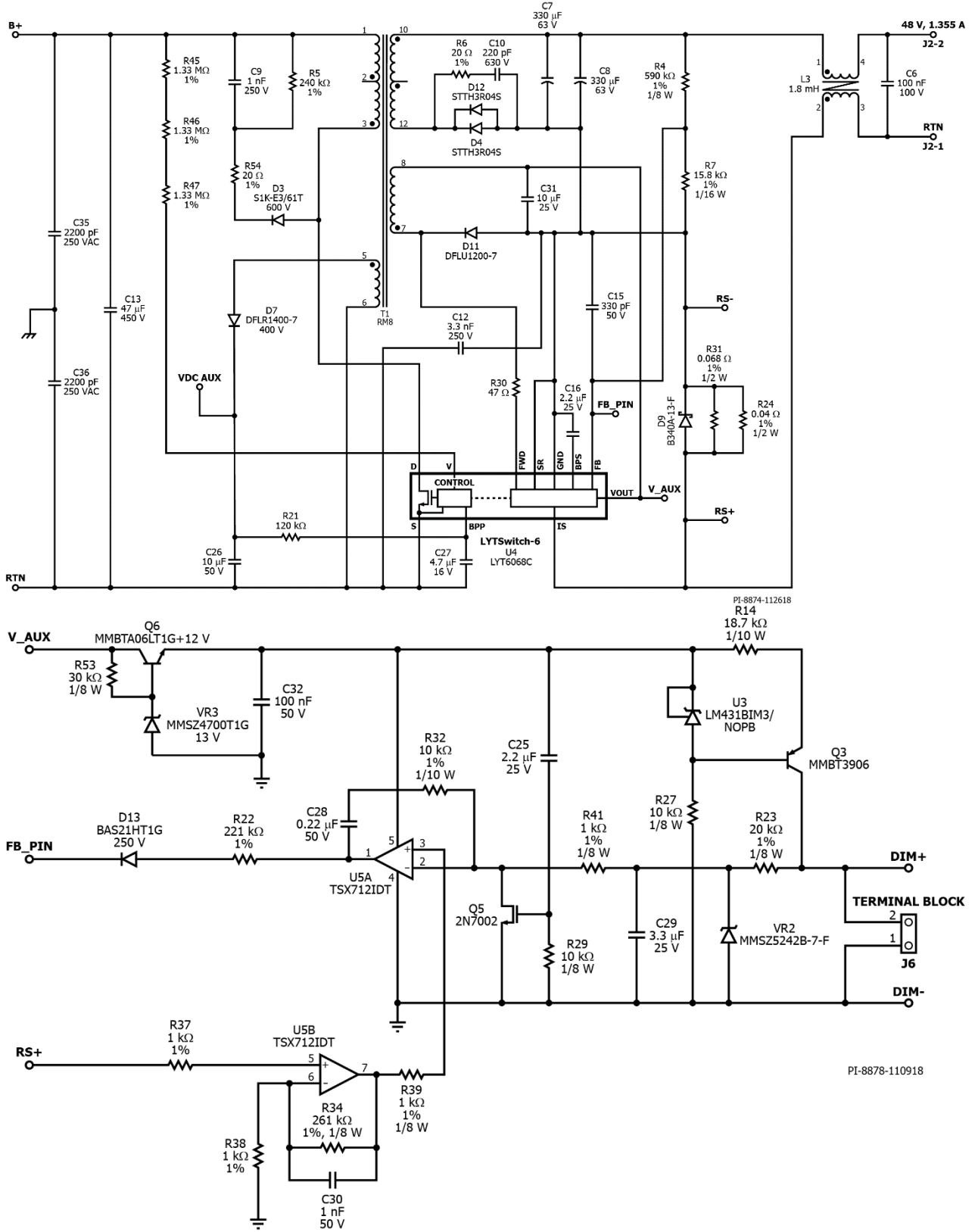

Figure 4 – Schematic.



4 Circuit Description

The HiperPFS-4 device ensures high power factor throughout the input range of 90 VAC to 277 VAC. It features an integrated 600 V MOSFET, a CCM boost PFC controller, and a gate driver in a single IC.

The LYTSwitch-6 device incorporates a primary 650 V power MOSFET, a safety-rated feedback mechanism, and both the primary-side and secondary-side controllers in a single IC. Through a novel inductive coupling feedback mechanism, FluxLink™, accurate and reliable means of communication between the primary and secondary controllers are possible.

The LED ballast combines Power Integration's HiperPFS-4 (PFS7624C) and LYTSwitch-6 (LYT6068C) designed to deliver a 65 W two stage power supply with 1350 mA constant current, fully dimmable from 36 V to 48 V.

4.1 Input Circuit Description

The input fuse F1 provides overcurrent protection and isolation in case of circuit failures. Thermistor RT1 limits the inrush current produced at start up. Varistor RV1 functions as a voltage clamp input in case of unwanted voltage spikes from transient line surge. Bridge rectifier BR1 rectifies the AC line voltage into a full wave rectified DC across the input capacitors C1 and C2.

Capacitors C1, C2, C3, C4, C33, C34, C35, and C36 together with inductors L1 and L2 constitute the EMI filter for attenuating both differential and common mode conducted noise produced by the switching operation of the driver.

4.2 HiperPFS-4 PFC Boost Converter

The PFC boost converter stage consists of the boost inductor T2 and the PFS7624C IC U2. This stage corrects the power factor by keeping the input current sinusoidal and at the same time providing a regulated output DC voltage to be used as input for the flyback stage.

Boost diode D5 utilizes a Qspeed™. Q-series LQA03TC600 for increased efficiency, reduced EMI noise, and cost effective solution.

Diode D2 provides an initial path for the inrush current at start up. This is important as a way to bypass the switching inductor T2 and switch U2 in order to prevent a resonant interaction between the boost inductor and output bulk capacitor C13.

Capacitor C14 provides a short, high-frequency return path to RTN. This effectively improves EMI results and reduces U2 MOSFET Drain voltage overshoot during turn off.

Capacitor C17 serves as a noise decoupler for the IC's internal reference. It also allows output power selection between "full" power mode, 100% of rated power [C17 = 1 μ F] or "efficiency" power mode, 80% of rated power [C17 = 0.1 μ F]. HiperPFS-4 IC U2 senses the rectified input DC voltage through the V pin using the resistor divider network comprised of resistors R10, R11, R13, R17, and R18. Capacitor C21 serves as a bypass capacitor for the V pin.

4.2.1 Output Feedback

A resistor divider network is used to linearly scale down the PFC output voltage as feedback to the controller U2 in order to regulate the PFC output voltage at 410 V. Capacitor C19 decouples the U2 FB pin.

4.2.2 Bias Supply Series Regulator

The HiperPFS-4 IC requires a regulated bias supply of 12 V in order to operate, with an absolute maximum rating of 15 V. The bias voltage must be externally clamped accordingly to prevent failure of the IC. Resistor R50, Zener diode VR1, and transistor Q1 form a series pass linear regulator that regulates the bias supply to 12 V. The linear regulator sources from the primary auxiliary winding of the DCDC transformer T3 at pin 5 and pin 6. Capacitor C18 decouples the VCC pin of U2.

4.3 Flyback Primary Circuit

The isolated flyback converter takes the 410 VDC output of the boost PFC stage as input. One end of the transformer (T3) primary is connected to the positive terminal of the bulk capacitor C13 while the other end is connected to the drain of the integrated 650 V MOSFET in the LYTSwitch-6 IC U4.

To limit the peak drain voltage spike of U4, a low-cost RCD snubber formed by D3, R5, R54, and C9 is used. To add on its purpose, it also helps dissipate the energy stored in the leakage reactance of T3.

To detect input overvoltage, the VOLTAGE MONITOR (V) pin of the LYTSwitch-6 IC uses resistors R45, R46, and R47 to connect to the positive terminal of bulk capacitor C13. These resistors convert the input voltage to current. I_{OV} sets the input overvoltage threshold.

During start-up, the LYTSwitch-6 IC is initially powered by an internal high-voltage current source that charges the BPP pin capacitor C27. The primary-side will listen for incoming secondary request signals for around 82 ms. Initially, the primary-side assumes control first and needs a handshake protocol to give the control to the secondary-side. During normal operation, the primary auxiliary winding of transformer T3 provides power to the primary-side control. Diode D7 and capacitor C26 rectifies and filters the auxiliary winding's output. Resistor R21 limits the current to BPP pin of U4 and is set to minimize no load power consumption.

The thermal shutdown circuitry senses the primary MOSFET die temperature. The threshold (T_{SD}) is typically set to 142 °C with 70 °C hysteresis $T_{SD(H)}$. When the die temperature rises above this threshold the power MOSFET is disabled and remains disabled until the die temperature falls by $T_{SD(H)}$ at which point it is re-enabled. A large hysteresis of 70 °C is provided to prevent over-heating of the PCB due to continuous fault condition.

4.4 LYTSwitch-6 Secondary-Side Control

The secondary-side control of the LYTSwitch-6 IC features output voltage and output current sensing, and a driver for an optional non-sync MOSFET for synchronous rectification. The output of the secondary of the transformer T3 is rectified by diodes D4 and D12 and filtered by capacitors C7 and C8. The RC snubber composed of resistor R6 and capacitor C10 reduces the voltage stress across the output diodes. The secondary-side control of the IC is powered through the secondary auxiliary winding of the transformer T3 on pin 7 and pin 8. The FORWARD (FWD) pin of the LYTSwitch-6 IC also connects to the switching node of the secondary auxiliary winding to provide the secondary-side control information on the primary switch timing.

During constant voltage operation, the output voltage is regulated using the resistor divider network of resistors R4 and R7 to sense the output voltage. The voltage across R7 is fed to FB pin of U4 and is compared with an internal reference voltage of 1.265 V. Capacitor C15 filters the voltage to FB pin to better regulate the output voltage.

During constant current operation, the output current is set by the sense resistors R31 and R24 across the IC's IS pin and GND pin. IS pin voltage is then compared to an internal reference voltage of 35.9 mV (as per data sheet). Diode D9 is placed in parallel with the sense resistors to protect the IS pin in case of output short circuit events.

The thermal foldback is activated when the secondary controller die temperature reaches 124 °C, the output power is reduced by reducing the constant current reference threshold. The thermal shutdown occurs when this secondary controller side reaches 135 °C up to 142 °C.

4.5 3-in-1 Dimming Circuit

Dimming is done by sensing the output current, amplifying the signal, comparing it with a variable reference and injecting current into the FB pin.

Output current is sensed through IS pin which has a threshold of 35.9 mV. The signal is then passed through the non-inverting amplifier circuit R34, R37, R38, R39, U5B, and C30. The gain is set by R34 and R38 to 262 or about 9.4 V maximum. The output of the op-amp (pin 7) connects to the positive input (pin 3) through R39. The signal going to the negative input (pin 2) comes from either of three possible inputs: variable DC supply (0 – 10 V), variable resistance (0 – 100 kΩ), or variable duty PWM signal (300 – 3 kHz).

The dimming input is converted to a variable 0-10V DC signal before feeding to the op-amp input. Resistor R23 and capacitor C29 convert the input signal to DC voltage before connecting to the op-amp via R41. A constant current source made from R14, R27, U3, and Q3 is used to convert the variable resistance input into the desired variable DC signal. U3 clamps the voltage at the base of Q3. Since the base emitter voltage is roughly constant (around 0.7 V), the voltage and current across R14 is effectively set constant. The emitter current of Q3 is roughly equal to its collector current which is connected to the variable resistance which in turn produces the 0 – 10 V needed. Zener diode VR2 is placed for protection from user connections on the 3-in-1 input terminals that excessively high voltages, or when the dimming input terminals are accidentally interchanged.

At start-up, the op-amp output is initially low which causes a momentary spike in output current. Due to this effect, a blanking circuit Q5, R29, and C25 is added which initially pulls the inverting input (pin 2) down and in turn results to op-amp output high.

The op-amp output (pin 1) is connected to the FB pin through R22 and D13. Depending on the op-amp output, current is injected into the FB pin. The feedback voltage will go up as current is injected. This will normally bring the output voltage down in CV mode. However, since the LED load is a constant voltage, it can't bring the voltage down. Instead, the output current goes down as a consequence.

The current injection loop has to be slow enough in order not to trigger feedback overvoltage protection when doing a step load from 100% to 0%. Resistor R22 is set such that dimming is operable for the LED output voltage range of 36 V to 48 V.

A low-input offset operational amplifier is also recommended to reduce unit-to-unit variability. It is also important to place the dimming circuit close to the IS pin and FB pin to prevent noise from disturbing the loop.

4.5.1 3-in-1 Dimming Set-up

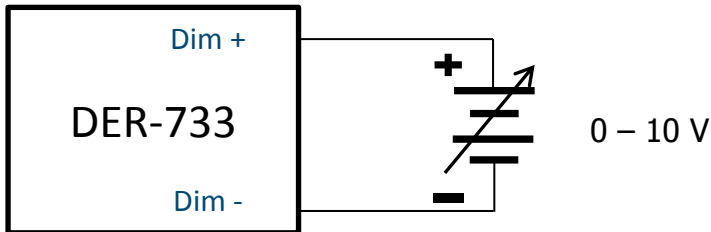
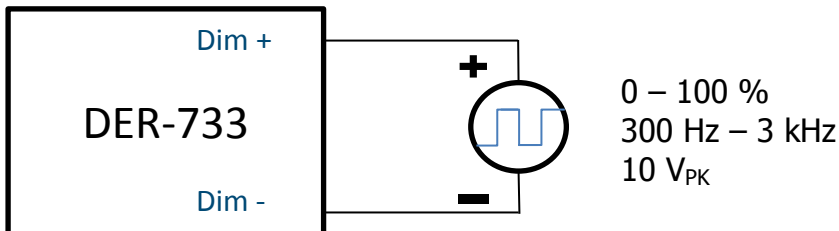
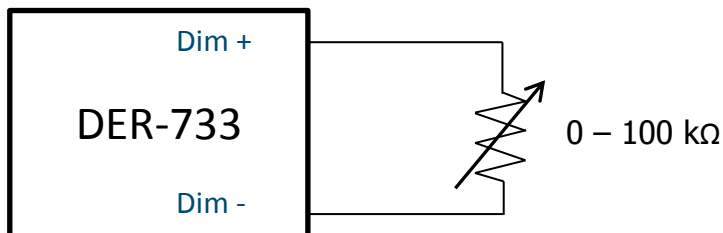
1. Variable DC Supply**Figure 5** – Dimming Set-up for Variable DC Supply Dimming Input.**2. Variable PWM Duty Cycle****Figure 6** – Dimming Set-up for Variable PWM Duty Cycle Dimming Input.**3. Variable Resistor****Figure 7** – Dimming Set-up for Variable Resistor Dimming Input.

5 PCB Layout

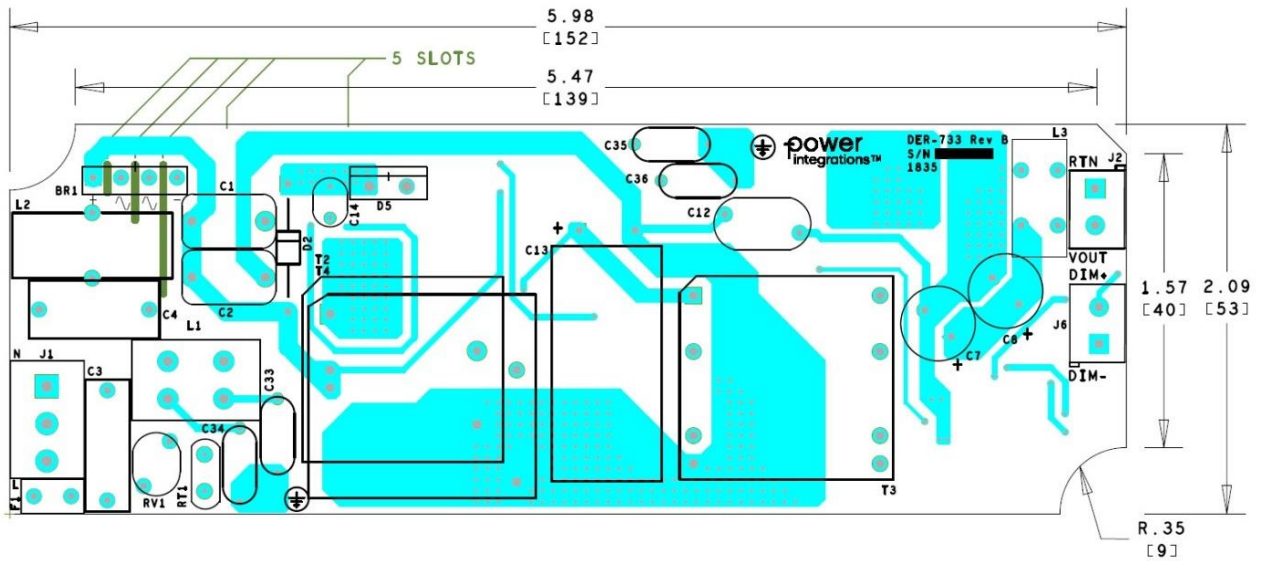

Figure 8 – Top Side.

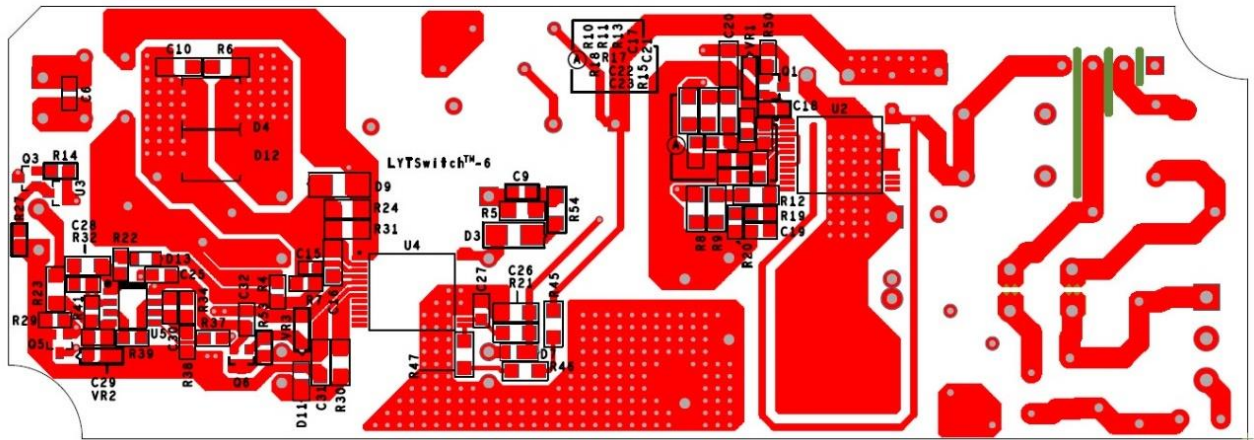

Figure 9 – Bottom Side.

6 Bill of Materials

6.1 Electricals

Item	Qty	Ref Des	Description	Mfg Part Number	Mfg
1	1	C1	330 nF, 450 V, METALPOLYPRO	ECW-F2W334JAQ	Panasonic
2	1	C2	330 nF, 450 V, METALPOLYPRO	ECW-F2W334JAQ	Panasonic
3	1	C3	68 nF, ±10%, 330 VAC, 760 VDC, X1 Safety Rated, Metallized Polypropylene Film, RAD, 0.709" L x 0.236" W (18.00 mm x 6.00 mm), 0.433" H (11.00 mm), 0.591" LS (15.00 mm)	B32912A3683K000	Epcos
4	1	C4	330 nF, 310 VAC, Film, X2	B32922C3334M	Epcos
5	1	C6	100 nF 100 V 10 % X7R 0805	C0805C104K1RACTU	Kemet
6	1	C7	330 µF, 63 V, Electrolytic, (10 x 20)	EKMG630ELL331MJ20S	United Chemi-con
7	1	C8	330 µF, 63 V, Electrolytic, (10 x 20)	EKMG630ELL331MJ20S	United Chemi-con
8	1	C9	1 nF, 250 V, Ceramic, X7R, 0805	GRM21AR72E102KW01D	Murata
9	1	C10	220 pF, 630 V, Ceramic, NP0, 1206	C3216C0G2J221J	TDK
10	1	C12	3.3 nF, Ceramic, Y1	440LD33-R	Vishay
11	1	C13	47 µF, 450 V, Electrolytic, Low ESR, (14.5 x 30)	EPAG451ELL470MU30S	Nippon Chemi-Con
12	1	C14	10 nF, 1 kV, Disc Ceramic, X7R	SV01AC103KAR	AVX
13	1	C15	330 pF 50 V, Ceramic, X7R, 0603	CC0603KRX7R9BB331	Yageo
14	1	C16	2.2 µF, 25 V, Ceramic, X7R, 1206	TMK316B7225KL-T	Taiyo Yuden
15	1	C17	100 nF, 50 V, Ceramic, X7R, 0805	CC0805KRX7R9BB104	Yageo
16	1	C18	1 µF, ±10%, 25 V, Ceramic, X7R, 0805	GCM21BR71E105KA56L	Murata
17	1	C19	470 pF, 50 V, Ceramic, X7R, 0805	CC0805KRX7R9BB471	Yageo
18	1	C20	10 µF, 10%, 50 V, Ceramic, X7R, -55°C ~ 125°C, 1206, 0.126" L x 0.063" W (3.20 mm x 1.60 mm)	CL31B106KBHNNNE	Samsung
19	1	C21	470 pF, 50 V, Ceramic, X7R, 0805	CC0805KRX7R9BB471	Yageo
20	1	C22	100 nF, 25 V, Ceramic, X7R, 0805	08053C104KAT2A	AVX
21	1	C23	1 µF, ±10%, 50 V, Ceramic, X7R, AEC-Q200, Automotive, Boardflex Sensitive, 0805, -55°C ~ 125°C	CGA4J3X7R1H105K125AE	TDK
22	1	C25	2.2 µF, 25 V, Ceramic, X7R, 0805	C2012X7R1E225M	TDK
23	1	C26	10 µF, 10%, 50V, Ceramic, X7R, -55°C ~ 125°C, 1206, 0.126" L x 0.063" W (3.20 mm x 1.60 mm)	CL31B106KBHNNNE	Samsung
24	1	C27	4.7 µF, 16 V, Ceramic, X7R, 0805	CL21B475KOFNNNE	Samsung
25	1	C28	0.22 µF, ±10%, 25V, Ceramic, X7R, -55°C ~ 125°C, 1206	CL31B224KACWPNC	Samsung
26	1	C29	3.3 µF, 25 V, Ceramic, X7R, 0805	C2012X7R1E335K	TDK
27	1	C30	1 nF, 50 V, Ceramic, X7R, 0805	08055C102KAT2A	AVX
28	1	C31	10 µF, 25 V, Ceramic, X7R, 1206	C3216X7R1E106M	TDK
29	1	C32	100 nF, 50 V, Ceramic, X7R, 0805	CC0805KRX7R9BB104	Yageo
30	1	C33	2200 pF, ±20%, 250 VAC, X1, Y1, Disc Ceramic	DE1E3KX222MN4AN01F	Murata
31	1	C34	2200 pF, ±20%, 250 VAC, X1, Y1, Disc Ceramic	DE1E3KX222MN4AN01F	Murata
32	1	C35	2200 pF, ±20%, 250 VAC, X1, Y1, Disc Ceramic	DE1E3KX222MN4AN01F	Murata
33	1	C36	2200 pF, ±20%, 250 VAC, X1, Y1, Disc Ceramic	DE1E3KX222MN4AN01F	Murata
34	1	BR1	Bridge Rectifier, 1000 V, 4 A, 4-ESIP, D3K, -55°C ~ 150°C (TJ), Vf=1V @ 7.5 A	UD4KB100-BP	Micro Commercial
35	1	D2	800 V, 1 A, GP, Rectifier, DO-41	1N4006-E3/54	Vishay
36	1	D3	800 V, 1 A, DO214AC	S1K-E3/61T	Vishay
37	1	D4	400 V, 3 A, Fast Recovery = < 500ns, > 200mA (Io), DO-214AB, SMC	STTH3R04S	ST Micro
38	1	D5	600 V, 3 A, TO-220AC	LQA03TC600	Power Integrations
39	1	D7	400 V, 1 A, Rectifier, Glass Passivated, POWERDI123	DFLR1400-7	Diodes, Inc.
40	1	D9	DIODE, SCHOTTKY, 40 V, 3 A, SMA, DO-214AA	B340A-13-F	Diodes, Inc.
41	1	D11	DIODE, UFAST, 200 V, 1 A, POWERDI123	DFLU1200-7	Diodes, Inc.
42	1	D12	400 V, 3 A, Fast Recovery = < 500ns, > 200mA (Io), DO-214AB, SMC	STTH3R04S	ST Micro



43	1	D13	Diode, General Purpose, Power, Switching, SS SWCH DIO, 250V,SC-76, SOD-323	BAS21HT1G	ON Semi
44	1	Q1	NPN, Small Signal BJT, 80 V, 0.5 A, SOT-23	MMBTA06LT1G	ON Semi
45	1	Q3	PNP, Small Signal BJT, 40 V, 0.2 A, SOT-23	MMBT3906LT1G	ON Semi
46	1	Q5	60 V, 115 mA, SOT23-3	2N7002-7-F	Diodes, Inc.
47	1	Q6	NPN, Small Signal BJT, 80 V, 0.5 A, SOT-23	MMBTA06LT1G	ON Semi
48	1	VR1	13 V, 5%, 500 mW, SOD-123	MMSZ4700T1G	ON Semi
49	1	VR2	DIODE ZENER 12 V 500 mW SOD123	MMSZ5242B-7-F	Diodes, Inc.
50	1	VR3	13 V, 5%, 500 mW, SOD-123	MMSZ4700T1G	ON Semi
51	1	R4	RES, 590 k Ω , 1%, 1/8 W, Thick Film, 0805	ERJ-6ENF5903V	Panasonic
52	1	R5	RES, 240 k Ω , 5%, 1/4 W, Thick Film, 1206	ERJ-8GEYJ244V	Panasonic
53	1	R6	RES, 20 Ω , 5%, 1/4 W, Thick Film, 1206	ERJ-8GEYJ200V	Panasonic
54	1	R7	RES, 15.8 k Ω , 1%, 1/8 W, Thick Film, 0805	ERJ-6ENF1582V	Panasonic
55	1	R8	RES, 3.74 M Ω , 1%, 1/4 W, Thick Film, 1206	CRCW12063M74FKEA	Vishay
56	1	R9	RES, 6.2 M Ω , 1%, 1/4 W, Thick Film, 1206	KTR18EZPF6204	Rohm
57	1	R10	RES, 6.2 M Ω , 1%, 1/4 W, Thick Film, 1206	KTR18EZPF6204	Rohm
58	1	R11	RES, 6.2 M Ω , 1%, 1/4 W, Thick Film, 1206	KTR18EZPF6204	Rohm
59	1	R12	RES, 6.2 M Ω , 1%, 1/4 W, Thick Film, 1206	KTR18EZPF6204	Rohm
60	1	R13	RES, 3.74 M Ω , 1%, 1/4 W, Thick Film, 1206	CRCW12063M74FKEA	Vishay
61	1	R14	RES, 18.7 k Ω , 1%, 1/8 W, Thick Film, 0805	ERJ-6ENF1872V	Panasonic
62	1	R15	RES, 30.1 k Ω , 1%, 1/8 W, Thick Film, 0805	ERJ-6ENF3012V	Panasonic
63	1	R17	RES, 10 k Ω , 1%, 1/8 W, Thick Film, 0805	ERJ-6ENF1002V	Panasonic
64	1	R18	RES, 143 k Ω , 1%, 1/8 W, Thick Film, 0805	ERJ-6ENF1433V	Panasonic
65	1	R19	RES, 10 k Ω , 1%, 1/8 W, Thick Film, 0805	ERJ-6ENF1002V	Panasonic
66	1	R20	RES, 143 k Ω , 1%, 1/8 W, Thick Film, 0805	ERJ-6ENF1433V	Panasonic
67	1	R21	RES, 120 k Ω , 5%, 1/4 W, Thick Film, 1206	ERJ-8GEYJ124V	Panasonic
68	1	R22	RES, 221 k Ω , 1%, 1/8 W, Thick Film, 0805	ERJ-6ENF2213V	Panasonic
69	1	R23	RES, 20.0 k Ω , 1%, 1/4 W, Thick Film, 1206	ERJ-8ENF2002V	Panasonic
70	1	R24	0.04 Ω , $\pm 1\%$, ± 1200 ppm/ $^{\circ}$ C, -55 $^{\circ}$ C ~ 155 $^{\circ}$ C, 0.25 W, 1/4 W, 1206, Automotive AEC-Q200, Current Sense, Moisture Resistant, Thick Film	RL1206FR-070R04L	Yageo
71	1	R27	RES, 10 k Ω , 5%, 1/8 W, Thick Film, 0805	ERJ-6GEYJ103V	Panasonic
72	1	R29	RES, 10 k Ω , 5%, 1/8 W, Thick Film, 0805	ERJ-6GEYJ103V	Panasonic
73	1	R30	RES, 47 Ω , 5%, 1/4 W, Thick Film, 1206	ERJ-8GEYJ470V	Panasonic
74	1	R31	RES, SMD, 0.068, 68 m Ω , $\pm 1\%$, 0.5 W, 1/2 W, 1206, Automotive AEC-Q200, Current Sense, Moisture Resistant Thick Film	RL1206FR-7W0R068L	Yageo
75	1	R32	RES, 10 k Ω , 5%, 1/8 W, Thick Film, 0805	ERJ-6GEYJ103V	Panasonic
76	1	R34	RES, 261 k Ω , 1%, 1/8 W, Thick Film, 0805	ERJ-6ENF2553V	Panasonic
77	1	R37	RES, 1.00 k Ω , 1%, 1/8 W, Thick Film, 0805	ERJ-6ENF1001V	Panasonic
78	1	R38	RES, 1.00 k Ω , 1%, 1/8 W, Thick Film, 0805	ERJ-6ENF1001V	Panasonic
79	1	R39	RES, 1.00 k Ω , 1%, 1/8 W, Thick Film, 0805	ERJ-6ENF1001V	Panasonic
80	1	R41	RES, 1.00 k Ω , 1%, 1/8 W, Thick Film, 0805	ERJ-6ENF1001V	Panasonic
81	1	R45	RES, 1.33 M Ω , 1%, 1/4 W, Thick Film, 1206	RC1206FR-071M33L	Yageo
82	1	R46	RES, 1.33 M Ω , 1%, 1/4 W, Thick Film, 1206	RC1206FR-071M33L	Yageo
83	1	R47	RES, 1.33 M Ω , 1%, 1/4 W, Thick Film, 1206	RC1206FR-071M33L	Yageo
84	1	R50	RES, 100 k Ω , 5%, 1/8 W, Thick Film, 0805	ERJ-6GEYJ104V	Panasonic
85	1	R53	RES, 30 k Ω , 5%, 1/8 W, Thick Film, 0805	ERJ-6GEYJ303V	Panasonic
86	1	R54	RES, 20 Ω , 5%, 1/4 W, Thick Film, 1206	ERJ-8GEYJ200V	Panasonic
87	1	F1	3.15 A, 250 V, Slow, RST	507-1181	Belfuse
88	1	L1	20 mH, Common Mode Choke custom DER 801	30-04099-00	Power Integrations
89	1	L2	470 μ H, 1.6 A, Vertical Toroidal	2120-V-RC	Bourns
90	1	L3	Toroidal Common Mode Choke,1.8 mH, CUSTOM, DER 801	32-00375-00	Power Integrations
91	1	RT1	NTC Thermistor, 2.5 Ω , 3 A	SL08 2R503	Ametherm
92	1	RV1	300 Vac, 25 J, 7 mm, RADIAL	V300LA4P	Littlefuse
93	1	T2	Bobbin, EF25, 8pins		
94	1	T3	Bobbin, PQ26/20, Vertical, 12 pins	BPQ26/20-1112CPFR	TDK

95	1	U2	HiperPFS-4 Family, InSOP24B	PFS7624C	Power Integrations
96	1	U3	IC, REG ZENER SHUNT ADJ SOT-23	LM431BIM3/NOPB	National Semi
97	1	U4	LYTSwitch-6 Integrated Circuit, InSOP24D	LYT6068C	Power Integrations
98	1	U5	IC, DUAL Op Amp, General Purpose, 2.7MHz, Rail to Rail,8-SOIC	TSX712IDT	ST Micro

6.2 *Mechanicals and Miscellaneous*

Item	Qty	Ref Des	Description	Mfg Part Number	Mfg
99	1	J1	CONN TERM BLOCK 5.08 MM 3POS, Screw - Leaf Spring, Wire Guard	ED120/3DS	On Shore Tech
100	1	J2	CONN TERM BLOCK, 2 POS, 5 mm, PCB	ED500/2DS	On Shore Tech
101	1	J6	CONN TERM BLOCK, 2 POS, 5 mm, PCB	ED500/2DS	On Shore Tech



7 Flyback Transformer (T3) Specification

7.1 Electrical Diagram

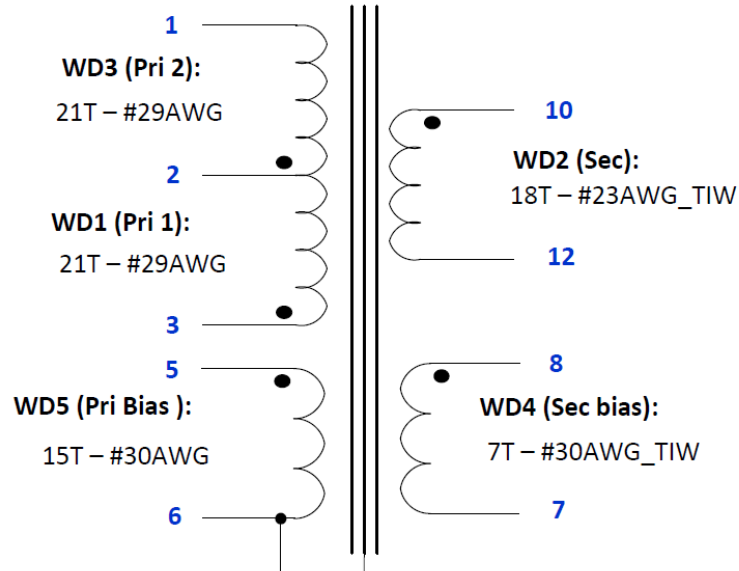

Figure 10 – Transformer Electrical Diagram.

7.2 Electrical Specifications

Parameter	Condition	Spec.
Nominal Primary Inductance	Measured at 1 V _{PK-PK} , 100 kHz switching frequency, between pin 3 and pin 1 with all other windings open.	720 μ H
Tolerance	Tolerance of Primary Inductance.	\pm 5%
Leakage Inductance	Measured across primary winding with all other windings shorted	<6 μ H

7.3 Material List

Item	Description
[1]	Core: PQ2620 PC95 or Equivalent.
[2]	Bobbin, PQ2620, Vertical, 12 Pins.
[3]	Magnet Wire: #29 AWG.
[4]	Magnet Wire: #30 AWG.
[5]	TIW: # 23 AWG.
[6]	TIW: # 30 AWG.
[7]	Polyester Tape: 9.29 mm.
[8]	Polyester Tape: 11.6 mm.
[9]	Copper Tape.

7.4 Transformer Build Diagram

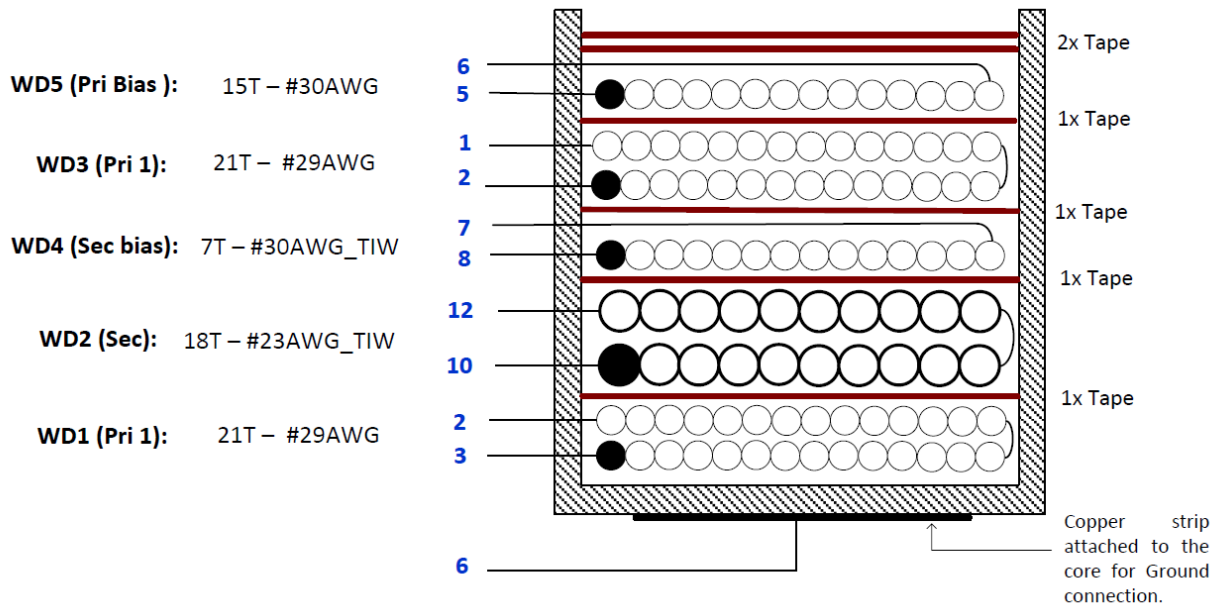
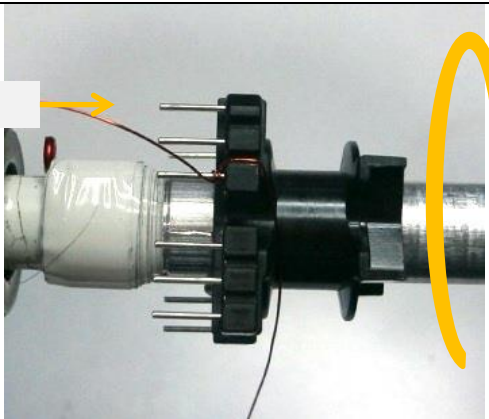
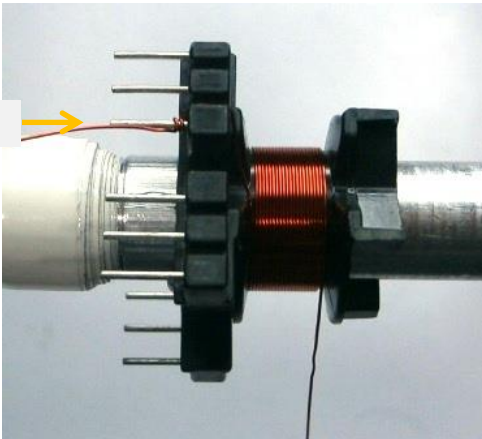
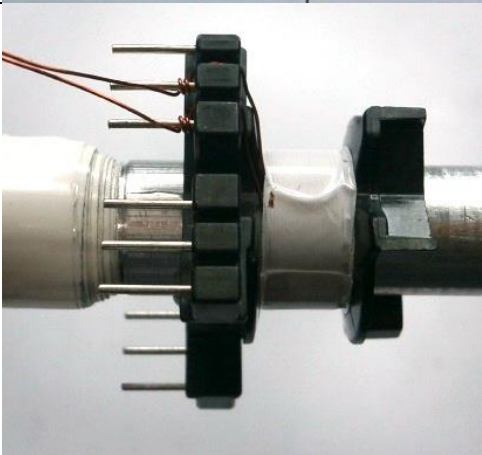



Figure 11 – Transformer Build Diagram.

7.5 Transformer Construction

Winding Directions	Bobbin is oriented on winder jig such that terminal pin 1-12 is on the right side. The winding direction is clockwise.
Winding 1	Use magnetic wire Item [3]. Start at pin (3) and wind 21 turns in 1 layer. Finish at pin (2).
Insulation	Apply 1 layer of polyester tape, Item [7] for insulation.
Winding 2	Use magnetic wire Item [5]. Start at pin (10) and wind 18 turns. Finish at pin (12).
Insulation	Apply 1 layer of polyester tape, Item [7] for insulation.
Winding 3	Use magnetic wire Item [6]. Start at pin (8) and wind 7 turns. Finish at pin (7).
Insulation	Apply 1 layer of polyester tape, Item [7] for insulation.
Winding 4	Use magnetic wire Item [3]. Start at pin (2) and wind 21 turns in 1 layer. Finish at pin (1).
Insulation	Apply 1 layer of polyester tape, Item [7] for insulation.
Winding 5	Use magnetic wire Item [4]. Start at pin (5) and wind 15 turns. Finish at pin (6).
Insulation	Apply 2 layers of polyester tape, Item [7] for insulation.
Core Grinding	Grind the center leg of the ferrite core to meet the nominal inductance specification of 720 μ H.
Core Termination	Apply a small strip of Item [9] and connect to pin (6) for ground termination.
Assemble Core	Use Item [8] to fix the 2 cores into the bobbin. Apply 2 layers of polyester tape firmly around the core.
Pins	Cut any excess pins of the bobbin (pins without wire terminations).
Finish	Dip the transformer in a 2:1 varnish and thinner solution.

7.6 Transformer Winding Illustrations

<p>Winding Directions</p> <p>Bobbin is oriented on winder jig such that terminal pin 1-12 is on the right side. The winding direction is clockwise.</p>	
<p>Winding 1</p> <p>Use magnetic wire Item [3]. Start at pin (3) and wind 21 turns in 1 layer. Finish at pin (2).</p>	
<p>Insulation</p> <p>Apply 1 layer of polyester tape, Item [7] for insulation</p>	

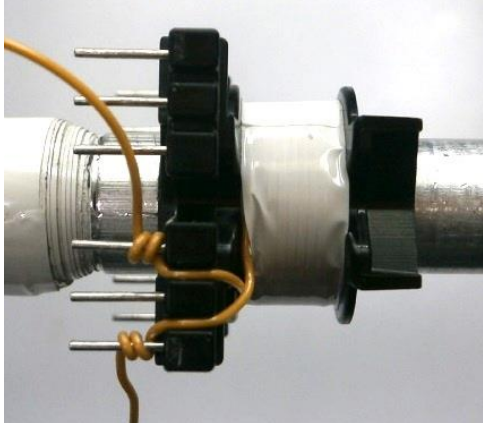
<p>Winding 2</p> <p>Use magnetic wire Item [5]. Start at pin (10) and wind 18 turns in 2 layers. Finish at pin (12).</p>	
<p>Insulation</p> <p>Apply 1 layer of polyester tape, Item [7] for insulation.</p>	

Winding 3

Use magnetic wire Item [6]. Start at pin (8) and wind 7 turns. Finish at pin (7).

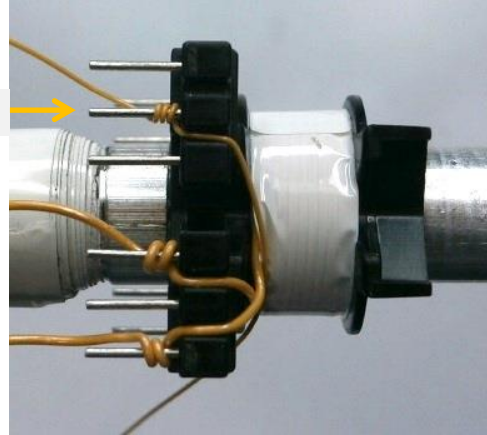
Pin 8**Insulation**

Apply 1 layer of polyester tape, Item [7] for insulation.



Winding 4

Use magnetic wire Item [3]. Start at pin (2) and wind 21 turns in 1 layer. Finish at pin (1).

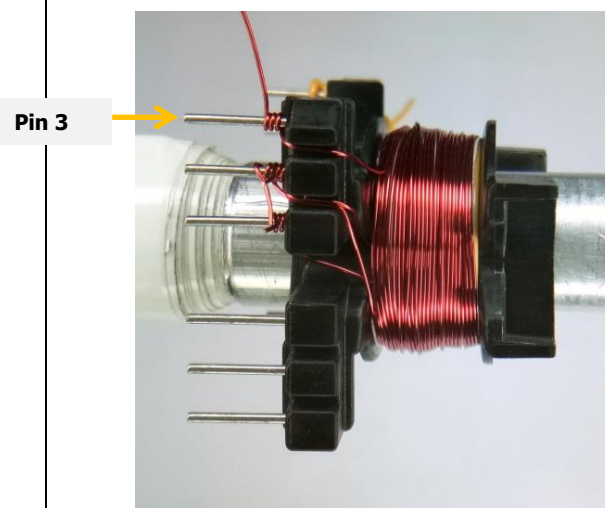
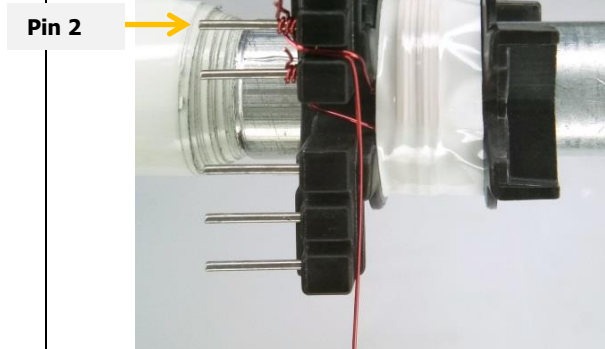

Insulation

Apply 1 layer of polyester tape, Item [7] for insulation.

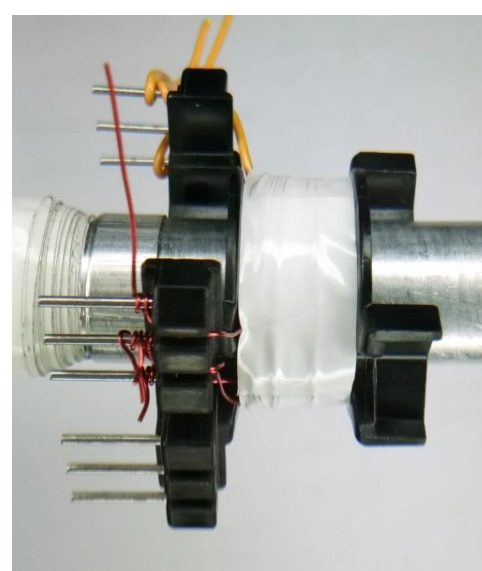

Winding 5

Use magnetic wire Item [4]. Start at pin (5) and wind 8 turns. Finish at pin (6).

**Insulation**

Apply 2 layers of polyester tape, Item [7] for insulation.

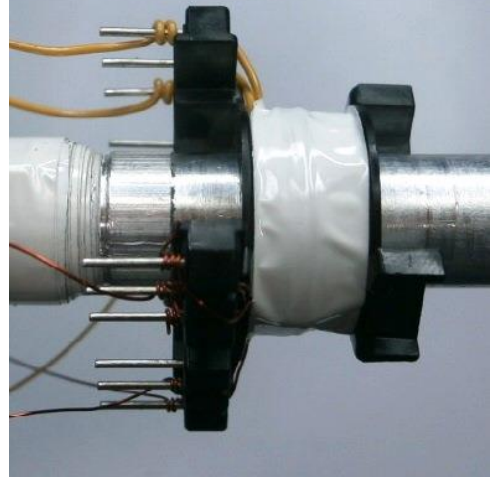

Core Termination

Use two PC95 PQ2620 cores, Item [1]. Grind the center leg of the ferrite core to meet the nominal inductance specification of 720 μH . Apply a small strip of Item [9] and connect to pin (6) for ground termination.

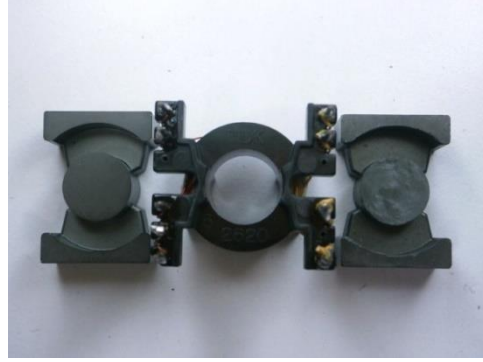
**Core Fixing**

Use Item [8] to fix the 2 cores into the bobbin. Apply 2 layers of polyester tape firmly around the core.

Pins

Cut any excess pins of the bobbin (pins without wire terminations).

Varnishing

Dip the transformer in a 2:1 varnish and thinner solution

Pin 6

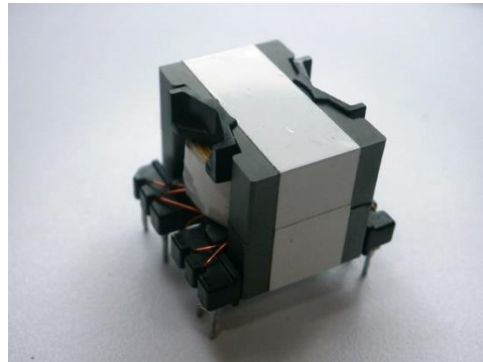
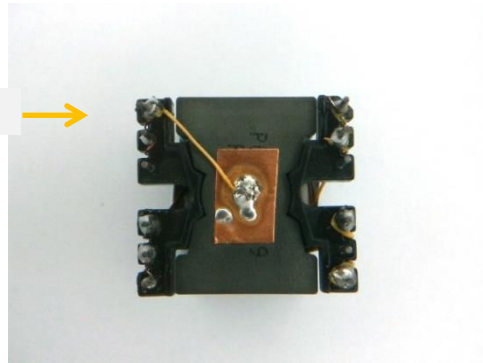

8 PFC Inductor (T2) Specifications

8.1 Electrical Diagram

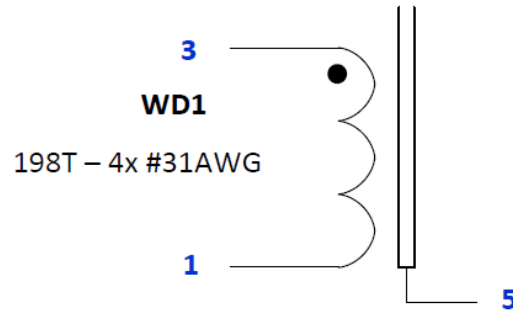

Figure 12 – Inductor Electrical Diagram.

8.2 Electrical Specifications

Parameter	Condition	Spec.
Nominal Primary Inductance	Measured at 1 V _{PK-PK} , 100 kHz switching frequency, between pin 1 and pin 3.	1050 μ H
Tolerance	Tolerance of Primary Inductance.	\pm 5%

8.3 Material List

Item	Description
[1]	Core: EF25 PC44 or Equivalent.
[2]	Bobbin: EF25, Horizontal, 8 pins.
[3]	Magnet Wire: #31 AWG.
[4]	Transformer Tape: 15 mm.
[5]	Transformer Tape: 9 mm.

8.4 Inductor Build Diagram

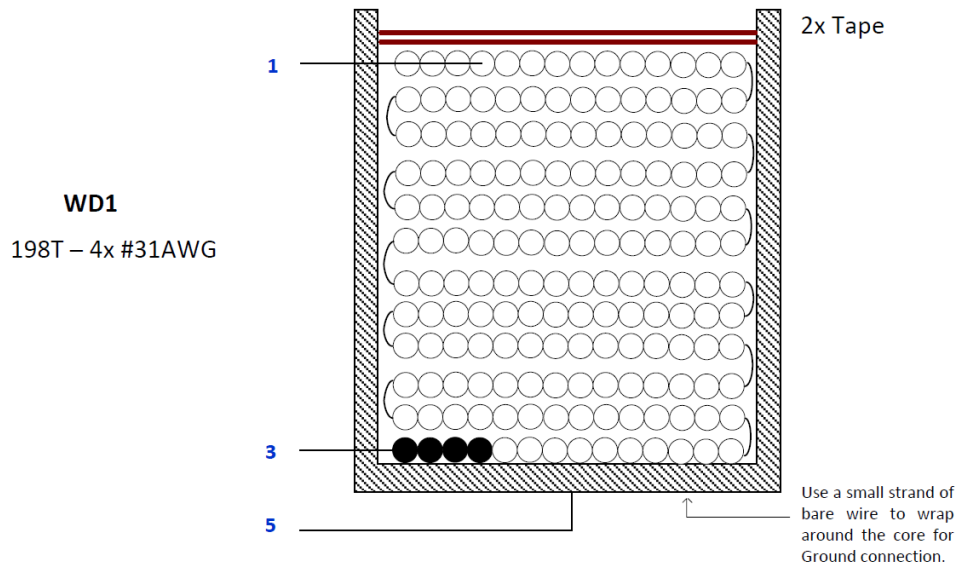

Figure 13 – Inductor Build Diagram.

8.5 Inductor Construction

Winding Directions	Bobbin is oriented on winder jig such that terminal pin 1 – 4 is in the left side. The winding direction is clockwise.
Winding 1	Use quad-filar magnetic wire Item [3] for winding. Start at pin (3) and wind 198 turns. Finish at pin (1).
Insulation	Add 2 layers of tape, Item [4] for insulation.
Core Grinding	Grind the center leg of the ferrite core evenly until it meets the nominal inductance of 1050 μ H. Inductance is measured across pin 3 and pin 1.
Assemble Core	Assemble the 2 cores on the bobbin.
Core Termination	Prepare a copper strip with a soldered magnetic wire, Item [3], at the middle as shown in the picture. Apply copper strip on one side of the core. Loop the magnetic wire around the core and terminate it on pin 5.
Core Tape	Add 2 layers of tape, Item [5], around the core to fix the 2 cores into the bobbin.
Pins	Pull out or cut Terminal pin no. 2, 4, 6, and pin 8.
Finish	Dip the transformer assembly in 2:1 varnish and thinner solution.

8.6 Inductor Winding Illustrations

Winding Directions

Bobbin is oriented on winder jig such that terminal pin 1 – 4 is in the left side. The winding direction is clockwise.

Winding 1

Use quad-filar magnetic wire Item [3] for winding. Start at pin (3) and wind 198 turns. Finish at pin (1).

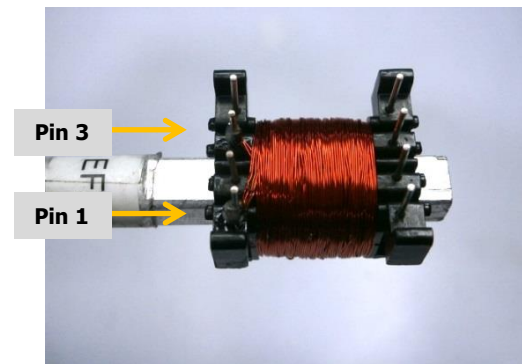

Insulation

Add 2 layers of tape, Item [4] for insulation

**Core Termination**

Prepare a copper strip with a soldered magnetic wire, Item [3], at the middle as shown in the picture. Apply copper strip on one side of the core. Loop the magnetic wire around the core and terminate it on pin 5.

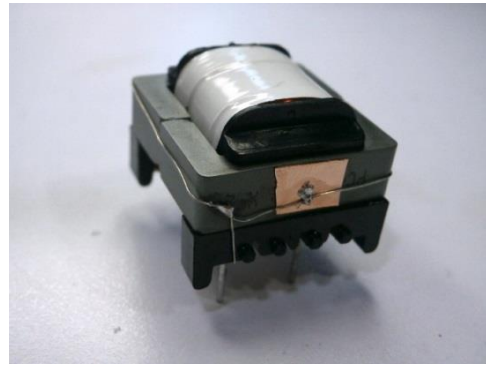
**Core Tape**

Add 2 Layers of tape Item [5] around the core to fix the 2 cores into the bobbin.

PINS

Pull out or cut Terminal pin no. 2, 4, 6, and pin 8.

Finish

Dip the transformer assembly in 2:1 varnish and thinner solution.

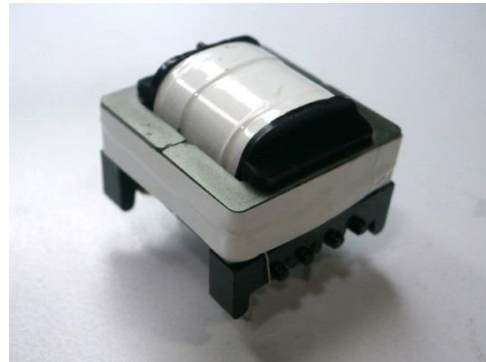

9 Design Spreadsheet

9.1 HiperPFS-4 Spreadsheet

1	Hiper_PFS-4_Boost_062918; Rev.1.1; Copyright Power Integrations 2018	INPUT	INFO	OUTPUT	UNITS	Continuous Mode Boost Converter Design Spreadsheet
2	Enter Application Variables					
3	Input Voltage Range	Universal		Universal		Input voltage range
4	VACMIN	90		90	VAC	Minimum AC input voltage. Spreadsheet simulation is performed at this voltage. To examine operation at other voltages, enter here, but enter fixed value for LPFC_ACTUAL.
5	VACMAX	277		277	VAC	Maximum AC input voltage
6	VBROWNIN		Info	84	VAC	Brown-IN voltage has been modified since the V-pin ratio is no longer 100:1
7	VBROWNOUT		Info	73	VAC	Brown-OUT voltage has been modified since the V-pin ratio is no longer 100:1
8	VO	410	Info	410	VDC	Brown IN/OUT voltage has changed due to modifications in the V-pin ratio from 100:1. Recommend Vpin ratio= FB pin ratio for optimized operation. Check the PF, input current distortion, brown in/out and power delivery
9	PO	70		70	W	Nominal Output power
10	fL			50	Hz	Line frequency
11	TA Max			40	°C	Maximum ambient temperature
12	n			0.93		Efficiency should be between 0.85 and 0.99. Also, refer to the Loss Budget section and ensure that the estimated efficiency is close to the simulated efficiency
13	VO_MIN			390	VDC	Minimum Output voltage
14	VO_RIPPLE_MAX			20	VDC	Maximum Output voltage ripple
15	tHOLDUP			20	ms	Holdup time
16	VHOLDUP_MIN			310	VDC	Minimum Voltage Output can drop to during holdup
17	I_INRUSH			40	A	Maximum allowable inrush current
18	Forced Air Cooling	No		No		Enter "Yes" for Forced air cooling. Otherwise enter "No". Forced air reduces acceptable choke current density and core autpick core size
20	KP and INDUCTANCE					
21	KP_TARGET	0.73		0.73		Target ripple to peak inductor current ratio at the peak of VACMIN. Affects inductance value
22	LPFC_TARGET (0 bias)			1042	uH	PFC inductance required to hit KP_TARGET at peak of VACMIN and full load
23	LPFC_DESIRED (0 bias)		Info	1042	uH	Inductance too high: Core size will be too big
24	KP_ACTUAL			0.689		Actual KP calculated from LPFC_ACTUAL
25	LPFC_PEAK			1042	uH	Inductance at VACMIN, 90°. For Ferrite, same as LPFC_DESIRED (0 bias)
27	Basic current parameters					
28	IAC_RMS			0.84	A	AC input RMS current at VACMIN and Full Power load
29	IO_DC			0.17	A	Output average current/Average diode current
32	PFS Parameters					
33	PFS Package	C		C		HiperPFS package selection

34	PFS Part Number	PFS7624C		PFS7624C		If examining brownout operation, over-ride autopick with desired device size
35	Operating Mode	Efficiency		Efficiency		Mode of operation of PFS. For Full Power mode enter "Full Power" otherwise enter "EFFICIENCY" to indicate efficiency mode
36	IOCP min			4.5	A	Minimum Current limit
37	IOCP typ			4.8	A	Typical current limit
38	IOCP max			5.1	A	Maximum current limit
39	IP			1.73	A	MOSFET peak current
40	IRMS			0.74	A	PFS MOSFET RMS current
41	RDSOn			0.73	Ohms	Typical RDSon at 100 °C
42	FS_PK			62	kHz	Estimated frequency of operation at crest of input voltage (at VACMIN)
43	FS_AVG			46	kHz	Estimated average frequency of operation over line cycle (at VACMIN)
44	PCOND_LOSS_PFS			0.4	W	Estimated PFS conduction losses
45	PSW_LOSS_PFS			0.7	W	Estimated PFS switching losses
46	PFS_TOTAL			1.1	W	Total Estimated PFS losses
47	TJ Max			100	deg C	Maximum steady-state junction temperature
48	Rth-JS			2.80	°C/W	Maximum thermal resistance (Junction to heatsink)
49	HEATSINK Theta-CA			51.11	°C/W	Maximum thermal resistance of heatsink
52	INDUCTOR DESIGN					
53	Basic Inductor Parameters					
54	LPFC (0 Bias)			1042	uH	Value of PFC inductor at zero current. This is the value measured with LCR meter. For powder, it will be different than LPFC.
55	LP_TOL			10.0	%	Tolerance of PFC Inductor Value (ferrite only)
56	IL_RMS			0.85	A	Inductor RMS current (calculated at VACMIN and Full Power Load)
57	Material and Dimensions					
58	Core Type	Ferrite		Ferrite		Enter "Sendust", "Iron Powder" or "Ferrite"
59	Core Material	PC44/PC95		PC44/PC95		Select from 60u, 75u, 90u or 125 u for Sendust cores. Fixed at PC44/PC95 for Ferrite cores. Fixed at -52 material for Pow Iron cores.
60	Core Geometry	Auto		PQ		Toroid only for Sendust and Powdered Iron; EE or PQ for Ferrite cores.
61	Core	Auto		PQ26/20		Core part number
62	Ae	52.50		52.50	mm ²	Core cross sectional area
63	Le	57.50		57.50	mm	Core mean path length
64	AL	1900.00		1900.00	nH/t ²	Core AL value
65	Ve	3.02		3.02	cm ³	Core volume
66	HT (EE/PQ/EQ/RM/POT) / ID (toroid)			3.30	mm	Core height/Height of window; ID if toroid
67	MLT			56.2	mm	Mean length per turn
68	BW	15.00		15.00	mm	Bobbin width
69	LG			2.03	mm	Gap length (Ferrite cores only)
70	Flux and MMF calculations					
71	BP_TARGET (ferrite only)	5650	Info	5650	Gauss	Info: Peak flux density is too high. Check for Inductor saturation during line transient operation
72	B_OCP (or BP)		Warning	5625	Gauss	Warning: Peak flux density is too high. Check for Inductor saturation during load steps
73	B_MAX			1868	Gauss	peak flux density at AC peak, VACMIN and Full Power Load, nominal inductance
75	μ_TARGET (powder only)			N/A	%	target μ at peak current divided by μ at zero current, at VACMIN, full load (powder only) - drives auto core selection
76	μ_MAX (powder only)			N/A	%	mu_max greater than 75% indicates a very



						large core. Please verify
77	μ _OCP (powder only)			N/A	%	μ at IOCPtyp divided by μ at zero current
78	I_TEST	3.5		3.5	A	Current at which B_TEST and H_TEST are calculated, for checking flux at a current other than IOCP or IP; if blank IOCP_typ is used.
79	B_TEST			3860	Gauss	Flux density at I_TEST and maximum tolerance inductance
80	μ _TEST (powder only)			N/A	%	μ at IOCP divided by μ at zero current, at IOCPtyp
81	Wire					
82	TURNS			198		Inductor turns. To adjust turns, change BP_TARGET (ferrite) or μ _TARGET (powder)
83	ILRMS			0.85	A	Inductor RMS current
84	Wire type	Magnet		Magnet		Select between "Litz" or "Magnet" for double coated magnet wire
85	AWG		Info	31	AWG	!!! Info. Selected wire gauge is too thick and may cause increased losses due to skin effect. Consider using multiple strands of thinner wires or Litz wire
86	Filar	4		4		Inductor wire number of parallel strands. Leave blank to auto-calc for Litz
87	OD (per strand)			0.226	mm	Outer diameter of single strand of wire
88	OD bundle (Litz only)			N/A	mm	Will be different than OD if Litz
89	DCR			1.59	ohm	Choke DC Resistance
90	P AC Resistance Ratio		Info	2.56		AC resistance is high. Check copper loss, use Litz or thinner wire and fewer layers, or reduce Kp
91	J			5.30	A/mm ²	Estimated current density of wires. It is recommended that $4 < J < 6$
92	FIT			82%	%	Percentage fill of winding window for EE/PQ core. Full window approx. 90%
93	Layers			13.4		Estimated layers in winding
94	Loss calculations					
95	BAC-p-p			1363	Gauss	Core AC peak-peak flux excursion at VACMIN, peak of sine wave
96	LPFC_CORE_LOSS			0.09	W	Estimated Inductor core Loss
97	LPFC_COPPER_LOSS		Info	2.95	W	Info: Copper loss too high. Adjust wire gauge and/or filar, being mindful of AC Resistance ratio
98	LPFC_TOTAL_LOSS			3.04	W	Total estimated Inductor Losses
101	External PFC Diode					
102	PFC Diode Part Number	Auto		LXA03T600		PFC Diode Part Number
103	Type			Qspeed		PFC Diode Type
104	Manufacturer			PI		Diode Manufacturer
105	VRRM			600.00	V	Diode rated reverse voltage
106	IF			3.00	A	Diode rated forward current
107	Qrr			50.00	nC	High Temperature
108	VF			2.10	V	Diode rated forward voltage drop
109	PCOND_DIODE			0.36	W	Estimated Diode conduction losses
110	PSW_DIODE			0.09	W	Estimated Diode switching losses
111	P_DIODE			0.45	W	Total estimated Diode losses
112	TJ Max			100	deg C	Maximum steady-state operating temperature
113	Rth-JS		Warning	1.90	degC/W	Warning, Rth too low
114	HEATSINK Theta-CA			132.21	degC/W	Maximum thermal resistance of heatsink
115	IFSM			23.00	A	Non-repetitive peak surge current rating. Consider larger size diode if inrush or thermal limited.
118	Output Capacitor					
119	COUT	Auto		47	uF	Minimum value of Output capacitance

120	VO_RIPPLE_EXPECTED			12.4	V	Expected ripple voltage on Output with selected Output capacitor
121	T_HOLDUP_EXPECTED			24.2	ms	Expected holdup time with selected Output capacitor
122	ESR_LF		Warning	4.23	ohms	!!! Warning Low frequency ESR must be between 0.01 and 3 ohms
123	ESR_HF		Warning	1.69	ohms	!!! Warning high frequency ESR must be between 0.01 and 1 ohms
124	IC_RMS_LF			0.11	A	Low Frequency Capacitor RMS current
125	IC_RMS_HF			0.33	A	High Frequency Capacitor RMS current
126	CO_LF_LOSS			0.05	W	Estimated Low Frequency ESR loss in Output capacitor
127	CO_HF_LOSS			0.18	W	Estimated High frequency ESR loss in Output capacitor
128	Total CO LOSS			0.24	W	Total estimated losses in Output Capacitor
131	Input Bridge (BR1) and Fuse (F1)					
132	I ² t Rating			3.61	A ² *s	Minimum I ² t rating for fuse
133	Fuse Current rating			1.23	A	Minimum Current rating of fuse
134	VF			0.90	V	Input bridge Diode forward Diode drop
135	I _{AVG}			0.76	A	Input average current at 70 VAC.
136	PIV_INPUT BRIDGE			392	V	Peak inverse voltage of input bridge
137	PCOND_LOSS_BRIDGE			1.36	W	Estimated Bridge Diode conduction loss
138	CIN			0.2	uF	Input capacitor. Use metallized polypropylene or film foil type with high ripple current rating
139	RT1			9.79	ohms	Input Thermistor value
140	D_Precharge			1N5407		Recommended precharge Diode
143	PFS4 small signal components					
144	C_REF			0.1	uF	REF pin capacitor value
145	RV1			4.0	MOhms	Line sense resistor 1
146	RV2			6.0	MOhms	Line sense resistor 2
147	RV3			6.0	MOhms	Typical value of the lower resistor connected to the V-PIN. Use 1% resistor only!
148	RV4			151.7	kOhms	Description pending, could be modified based on feedback chain R1-R4
149	C_V			0.527	nF	V pin decoupling capacitor (RV4 and C_V should have a time constant of 80us) Pick the closest available capacitance.
150	C_VCC			1.0	uF	Supply decoupling capacitor
151	C_C			100	nF	Feedback C pin decoupling capacitor
152	Power good Vo lower threshold VPG(L)			333	V	Vo lower threshold voltage at which power good signal will trigger
153	PGT set resistor			312.7	kohm	Power good threshold setting resistor
156	Feedback Components					
157	R1			4.0	Mohms	Feedback network, first high voltage divider resistor
158	R2			6.0	Mohms	Feedback network, second high voltage divider resistor
159	R3			6.0	Mohms	Feedback network, third high voltage divider resistor
160	R4			151.7	kohms	Feedback network, lower divider resistor
161	C1			0.527	nF	Feedback network, loop speedup capacitor. (R4 and C1 should have a time constant of 80us) Pick the closest available capacitance.
162	R5			29.4	kohms	Feedback network: zero setting resistor
163	C2			1000	nF	Feedback component- noise suppression capacitor
166	Loss Budget (Estimated at VACMIN)					
167	PFS Losses			1.11	W	Total estimated losses in PFS
168	Boost diode Losses			0.45	W	Total estimated losses in Output Diode
169	Input Bridge losses			1.36	W	Total estimated losses in input bridge



						module
170	Inductor losses			3.04	W	Total estimated losses in PFC choke
171	Output Capacitor Loss			0.24	W	Total estimated losses in Output capacitor
172	EMI choke copper loss			0.50	W	Total estimated losses in EMI choke copper
173	Total losses			6.20	W	Overall loss estimate
174	Efficiency			0.92		Estimated efficiency at VACMIN, full load.
177	CAPZero component selection recommendation					
178	CAPZero Device			CAP200DG		(Optional) Recommended CAPZero device to discharge X-Capacitor with time constant of 1 second
179	Total Series Resistance (Rcapzero1+Rcapzero2)			1.02	M-ohms	Maximum Total Series resistor value to discharge X-Capacitors
182	EMI filter components recommendation					
183	CIN_RECOMMENDED			470	nF	Metallized polyester film capacitor after bridge, ratio with Po
184	CX2			330	nF	X capacitor after differential mode choke and before bridge, ratio with Po
185	LDM_calc			317	uH	estimated minimum differential inductance to avoid <10kHz resonance in input current
186	CX1			330	nF	X capacitor before common mode choke, ratio with Po
187	LCM			10	mH	typical common mode choke value
188	LCM_leakage			30	uH	estimated leakage inductance of CM choke, typical from 30~60uH
189	CY1 (and CY2)			220	pF	typical Y capacitance for common mode noise suppression
190	LDM_Actual			287	uH	cal_LDM minus LCM_leakage, utilizing CM leakage inductance as DM choke.
191	DCR_LCM			0.10	Ohms	total DCR of CM choke for estimating copper loss
192	DCR_LDM			0.10	Ohms	total DCR of DM choke(or CM #2) for estimating copper loss

Note: CX2 can be placed between CM choke and DM choke depending on EMI design requirement.

9.2 LYTSwitch-6 Spreadsheet

1	DCDC_LYTSwitch 6_Flyback_10171 8; Rev.1.0; Copyright Power Integrations 2018	INPUT	INFO	OUTPUT	UNITS	DCDC LYTSwitch6 Flyback Design Spreadsheet
2	APPLICATION VARIABLES					
3	VDCIN_MIN	400		400	V	Minimum input DC voltage
4	VDCIN_MAX	420		420	V	Maximum input DC voltage
5	VOUT	48.00		48.00	V	Output voltage
6	IOUT	1.355		1.355	A	Output current
7	POUT		Info	65.04	W	The specified output power exceeds the device power capability: Verify thermal performance if no other warnings
8	EFFICIENCY	0.94		0.94		DC-DC efficiency estimate at full load
9	FACTOR_Z			0.50		Z-factor estimate
10	ENCLOSURE	OPEN FRAME		OPEN FRAME		Power supply enclosure
14	PRIMARY CONTROLLER SELECTION					
15	ILIMIT_MODE	INCREASED		INCREASED		Device current limit mode
16	VDRAIN_BREAKDO WN	650		650	V	Device breakdown voltage
17	DEVICE_GENERIC	AUTO		LYT60X8		Generic device code
18	DEVICE_CODE			LYT6068C		Actual device code
19	POUT_MAX			65	W	Power capability of the device based on thermal performance
20	RDSON_100DEG			1.53	Ω	Primary switch on time drain resistance at 100 degC
21	ILIMIT_MIN			1.683	A	Minimum current limit of the primary switch
22	ILIMIT_TYP			1.850	A	Typical current limit of the primary switch
23	ILIMIT_MAX			2.017	A	Maximum current limit of the primary switch
24	VDRAIN_ON_PRSW			0.26	V	Primary switch on time drain voltage
25	VDRAIN_OFF_PRSW		Warning	600.0	V	The peak drain voltage on the switch is higher than 585V : Decrease the device VOR
29	WORST CASE ELECTRICAL PARAMETERS					
30	FSWITCHING_MAX	74100		74100	Hz	Maximum switching frequency at full load and minimum DC input voltage
31	VOR	110.0		110.0	V	Secondary voltage reflected to the primary when the primary switch turns off
32	KP			1.04		Measure of continuous/discontinuous mode of operation
33	MODE_OPERATION			DCM		Mode of operation
34	DUTYCYCLE			0.209		Primary switch duty cycle
35	TIME_ON			3.48	us	Primary switch on-time
36	TIME_OFF			10.71	us	Primary switch off-time
37	LPRIMARY_MIN			684.1	uH	Minimum primary inductance
38	LPRIMARY_TYP			720.1	uH	Typical primary inductance
39	LPRIMARY_TOL			5.0	%	Primary inductance tolerance
40	LPRIMARY_MAX			756.1	uH	Maximum primary inductance
42	PRIMARY CURRENTS					
43	IPEAK_PRIMARY			1.868	A	Primary switch peak current
44	IPEDESTAL_PRIMAR Y			0.000	A	Primary switch current pedestal
45	IAVG_PRIMARY			0.168	A	Primary switch average current
46	IRIPPLE_PRIMARY			1.868	A	Primary switch ripple current
47	IRMS_PRIMARY			0.457	A	Primary switch RMS current
49	SECONDARY CURRENTS					
50	IPEAK_SECONDARY			4.358	A	Secondary winding peak current



51	IPEDESTAL_SECONDARY			0.000	A	Secondary winding current pedestal
52	IRMS_SECONDARY			2.034	A	Secondary winding RMS current
53	IRIPPLE_CAP_OUT					
57	TRANSFORMER CONSTRUCTION PARAMETERS					
58	CORE SELECTION					
59	CORE	PQ26/20		PQ26/20		Core selection
60	CORE CODE			B65877B0000R095		Core code
61	AE			122.30	mm ²	Core cross sectional area
62	LE			44.40	mm	Core magnetic path length
63	AL			6300	nH/turns ²	Ungapped core effective inductance
64	VE			5435.0	mm ³	Core volume
65	BOBBIN			B65878E0012D001		Bobbin
66	AW			33.00	mm ²	Window area of the bobbin
67	BW			9.00	mm	Bobbin width
68	MARGIN			0.0	mm	Safety margin width (Half the primary to secondary creepage distance)
70	PRIMARY WINDING					
71	NPRIMARY			42		Primary turns
72	BPEAK			3039	Gauss	Peak flux density
73	BMAX			2711	Gauss	Maximum flux density
74	BAC			1356	Gauss	AC flux density (0.5 x Peak to Peak)
75	ALG			408	nH/turns ²	Typical gapped core effective inductance
76	LG			0.352	mm	Core gap length
77	LAYERS_PRIMARY			2		Number of primary layers
78	AWG_PRIMARY	29		29	AWG	Primary winding wire AWG
79	OD_PRIMARY_INSULATED			0.337	mm	Primary winding wire outer diameter with insulation
80	OD_PRIMARY_BARE			0.286	mm	Primary winding wire outer diameter without insulation
81	CMA_PRIMARY			277	Cmil/A	Primary winding wire CMA
83	PRIMARY BIAS WINDING					
84	NBIAS_PRIMARY			6		Primary bias turns
86	SECONDARY WINDING					
87	NSECONDARY	18		18		Secondary turns
88	AWG_SECONDARY			23	AWG	Secondary winding wire AWG
89	OD_SECONDARY_INSULATED			0.879	mm	Secondary winding wire outer diameter with insulation
90	OD_SECONDARY_BARE			0.573	mm	Secondary winding wire outer diameter without insulation
91	CMA_SECONDARY			251	Cmil/A	Secondary winding wire CMA
93	SECONDARY BIAS WINDING					
94	NBIAS_SECONDARY			7		Secondary bias turns (Required only for VOUT>24V or VOUT<4.4V)
98	PRIMARY COMPONENTS SELECTION					
99	LINE UNDERVOLTAGE					
100	OV REQUIRED			428.4	V	Required DC over-voltage threshold
101	OV ACTUAL		Warning	430.2	V	The device voltage stress will be higher than 90% of the device BVDSS when overvoltage is triggered
102	RLS			3.64	MΩ	Connect two 1.82 MOhm resistors to the V-pin for the required UV/OV threshold
103	BROWN-IN ACTUAL			103.2	V	Actual DC brown-in threshold
104	BROWN-OUT ACTUAL			93.4	V	Actual DC brown-out threshold
107	PRIMARY BIAS WINDING DIODE					
108	VBIAS_PRIMARY	15.0		15.0	V	Rectified bias voltage
109	VF_BIAS_PRIMARY			0.70	V	Secondary bias winding diode forward



						drop
110	VREVERSE_PRIBIAS DIODE_PRIMARY			75.00	V	Primary bias diode reverse voltage (not accounting parasitic voltage ring)
111	CBIAS_PRIMARY			22	uF	Primary bias winding rectification capacitor
112	CBPP			4.70	uF	BPP pin capacitor
116	SECONDARY COMPONENTS					
117	FEEDBACK					
118	RFB_UPPER	590.00		590.00	kΩ	Upper feedback resistor (connected to the first output voltage)
119	RFB_LOWER			15.80	kΩ	Lower feedback resistor
120	CFB_LOWER			330	pF	Lower feedback resistor decoupling capacitor
122	RECTIFIER					
123	VREVERSE_RECTIFIER			228.0		Secondary rectifier reverse voltage (not accounting parasitic voltage ring)
124	TYPE_RECTIFIER	AUTO		DIODE		Type of secondary rectifier used
125	RECTIFIER	AUTO		STTH3R04		Secondary rectifier
126	VF_RECTIFIER			1.500		Secondary rectifier forward voltage drop
127	BVDSS_RECTIFIER			400		Breakdown voltage of the secondary rectifier
128	RDSON_RECTIFIER			NA		On-time drain to source resistance of the secondary rectifier
129	TRR_RECTIFIER			18.0		Reverse recovery time of the ultra-fast diode
131	SECONDARY BIAS WINDING DIODE					
132	VBIAS_SECONDARY	18		18	V	Rectified secondary bias voltage
133	VF_BIAS_SECONDARY			0.7	V	Secondary bias winding diode forward drop
134	VREVERSE_BIASDIODE_SECONDARY			88.00	V	Secondary bias diode reverse voltage (not accounting parasitic voltage ring)
135	CBIAS_SECONDARY			22	uF	Secondary bias winding rectification capacitor
139	TOLERANCE ANALYSIS					
140	USER_VDC			410	V	Input DC voltage corner to be evaluated
141	USER_ILIMIT	TYP		1.850	A	Current limit corner to be evaluated
142	USER_LPRIMARY	TYP		720.1	uH	Primary inductance corner to be evaluated
143	MODE_OPERATION			DCM		Mode of operation
144	KP			1.158		Measure of continuous/discontinuous mode of operation
145	FSWITCHING			61562	Hz	Switching frequency at full load and valley of the rectified minimum AC input voltage
146	DUTYCYCLE			0.188		Steady state duty cycle
147	TIME_ON			3.06	us	Primary switch on-time
148	TIME_OFF			13.19	us	Primary switch off-time
149	IPEAK_PRIMARY			1.740	A	Primary switch peak current
150	IPEDESTAL_PRIMARY			0.000	A	Primary switch current pedestal
151	IAVERAGE_PRIMARY			0.164	A	Primary switch average current
152	IRIPPLE_PRIMARY			1.740	A	Primary switch ripple current
153	IRMS_PRIMARY			0.436	A	Primary switch RMS current
154	BPEAK			2655	Gauss	Peak flux density
155	BMAX			2439	Gauss	Maximum flux density
156	BAC			1220	Gauss	AC flux density (0.5 x Peak to Peak)



10 Performance Data

All measurements were performed at room temperature.

10.1 Output Current Regulation

Set-up: Open frame unit.
Load: 36 - 48 V 1350 mA LED load.
Ambient Temperature: 25 °C.
Soak Time: 10 minutes.

Output Regulation is within $\pm 5\%$ throughout the input line voltage range.

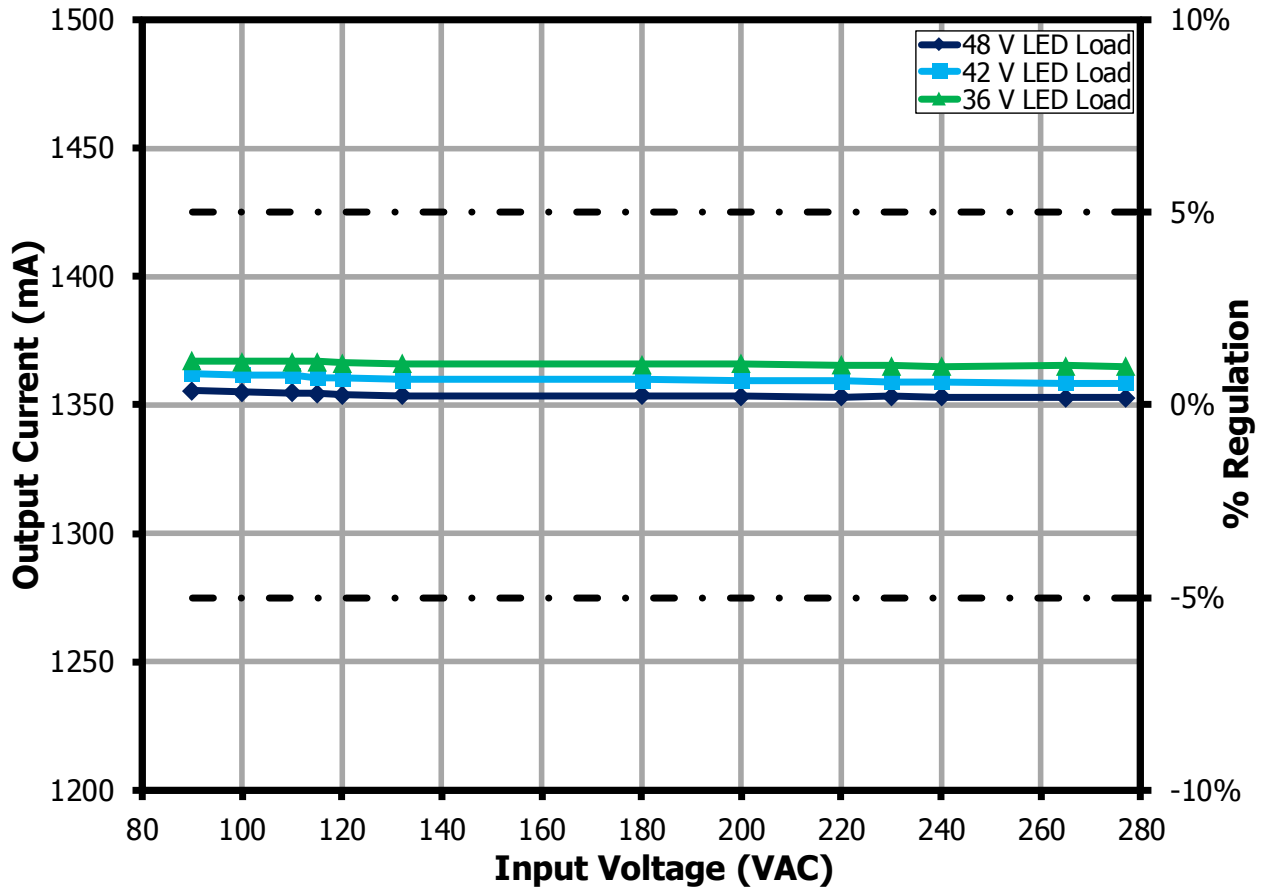

Figure 14 – Output Current Regulation vs. Input Line Voltage.



10.2 System Efficiency

Set-up: Open frame unit.
Load: 36 - 48 V 1350 mA LED load.
Ambient Temperature: 25 °C.
Soak Time: 10 minutes.

Efficiency is greater than 86 % throughout the input voltage range.

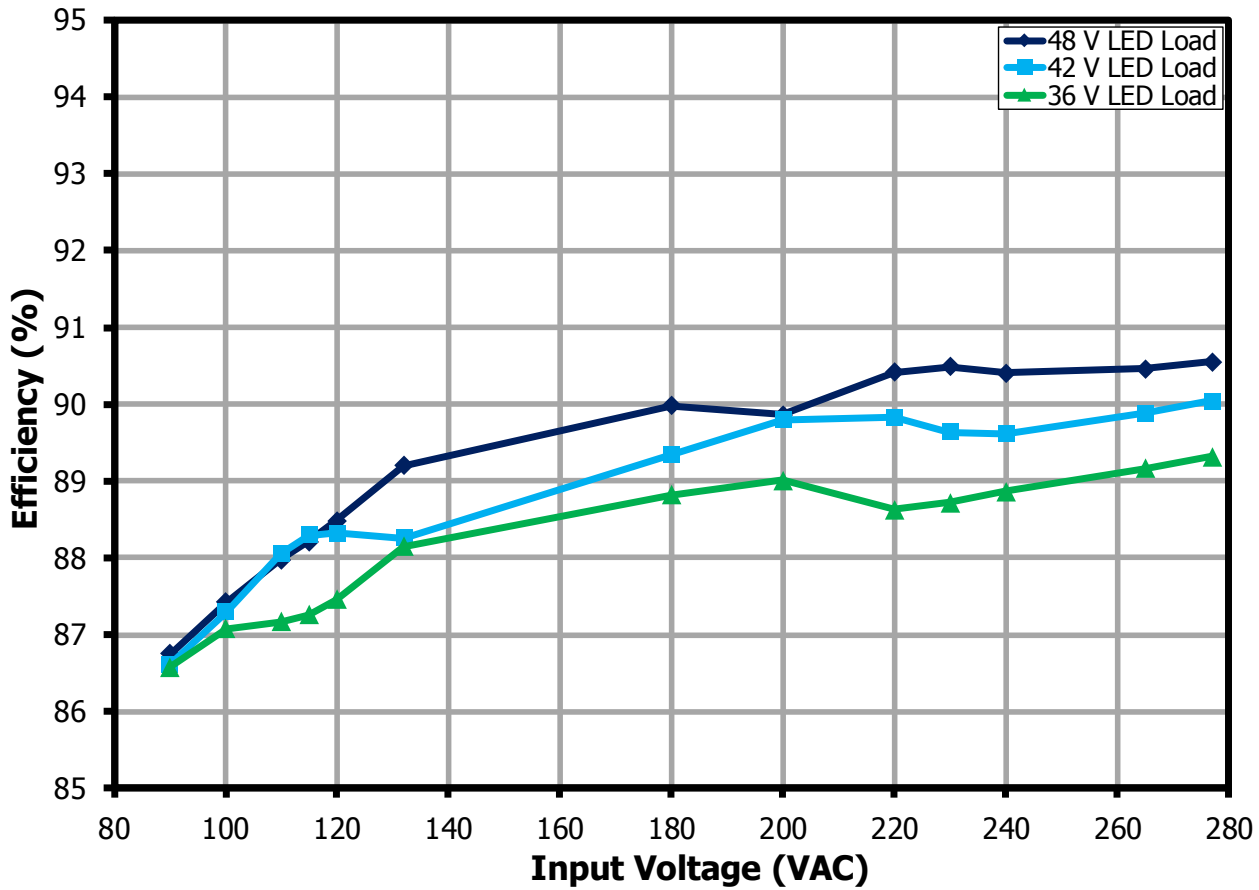

Figure 15 – Efficiency vs. Input Line Voltage.

10.3 Power Factor

Set-up: Open frame unit.
Load: 36 - 48 V 1350 mA LED load.
Ambient Temperature: 25 °C.
Soak Time: 10 minutes.
 Power Factor is greater than 0.9 throughout the input voltage range.

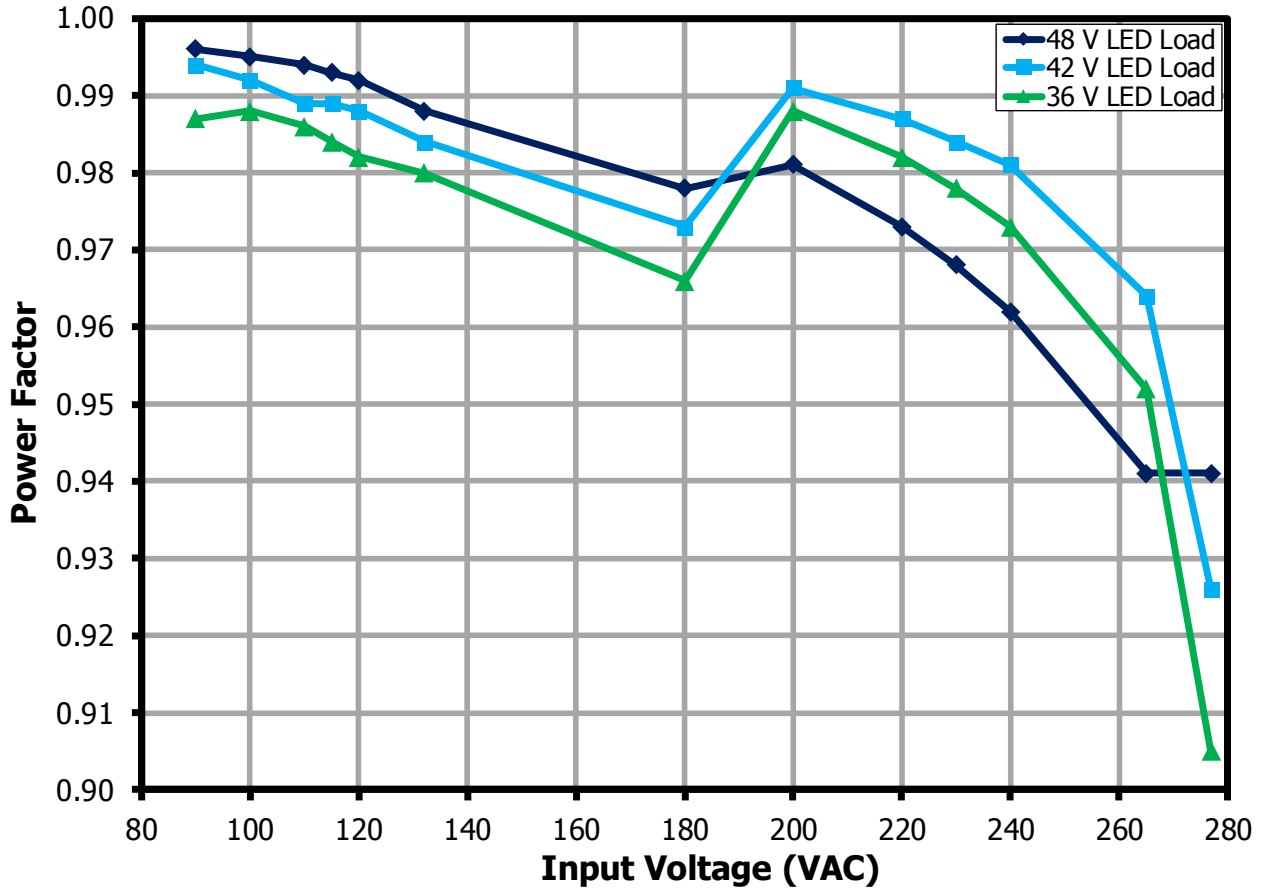

Figure 16 – Power Factor vs. Input Line Voltage.



10.4 %ATHD

Set-up: Open frame unit.
Load: 36 - 48 V 1350 mA LED load.
Ambient Temperature: 25 °C.
Soak Time: 10 minutes.
ATHD is less than 20 % throughout the input voltage range.

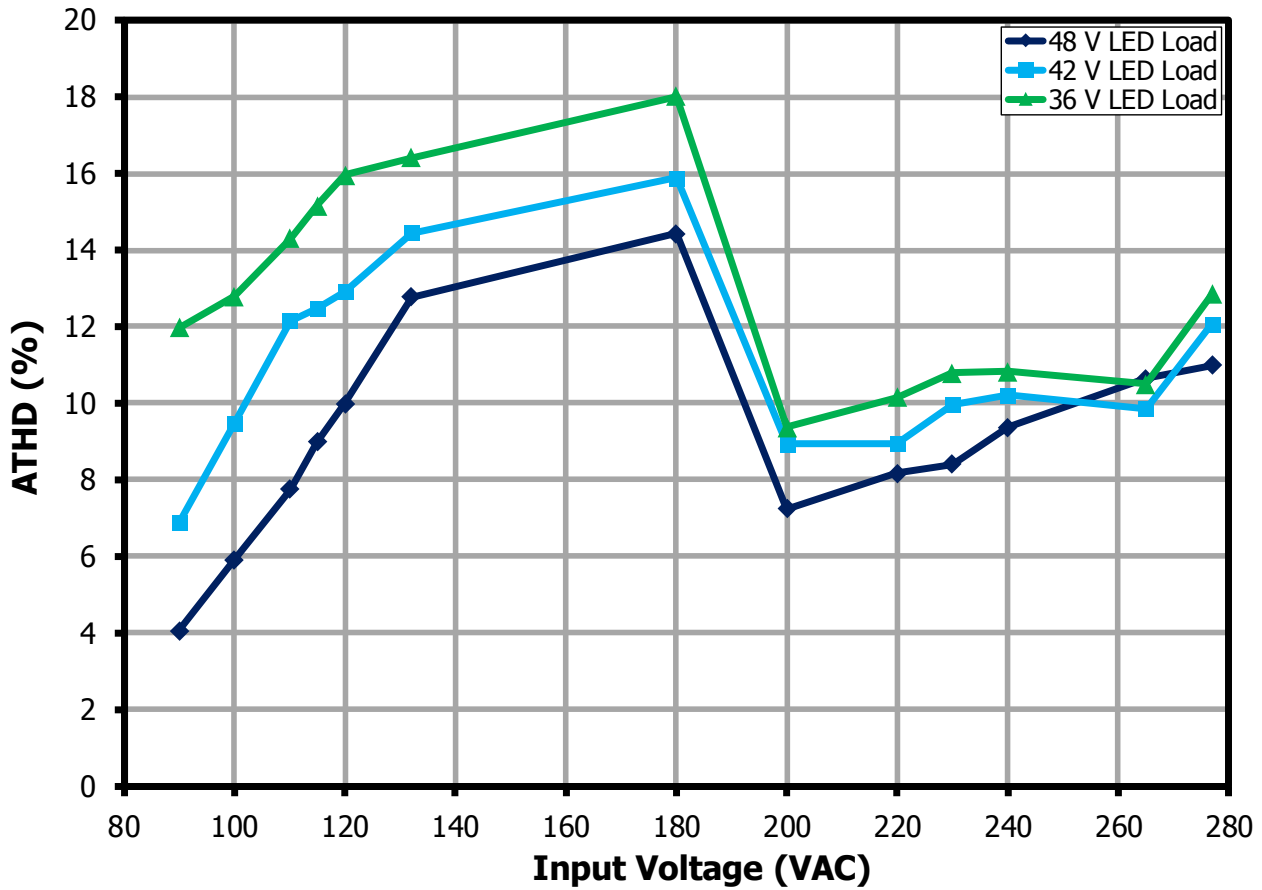

Figure 17 – %ATHD vs. Input Line Voltage.

10.5 Individual Harmonics Content at Full Load

Individual current harmonics are well below the Class C limit.

10.5.1 Low Line

Set-up: Open frame unit.
Load: 48 V 1350 mA LED load.
VIN: 115 V 60 Hz.
Ambient Temperature: 25 °C.
Soak Time: 10 minutes.

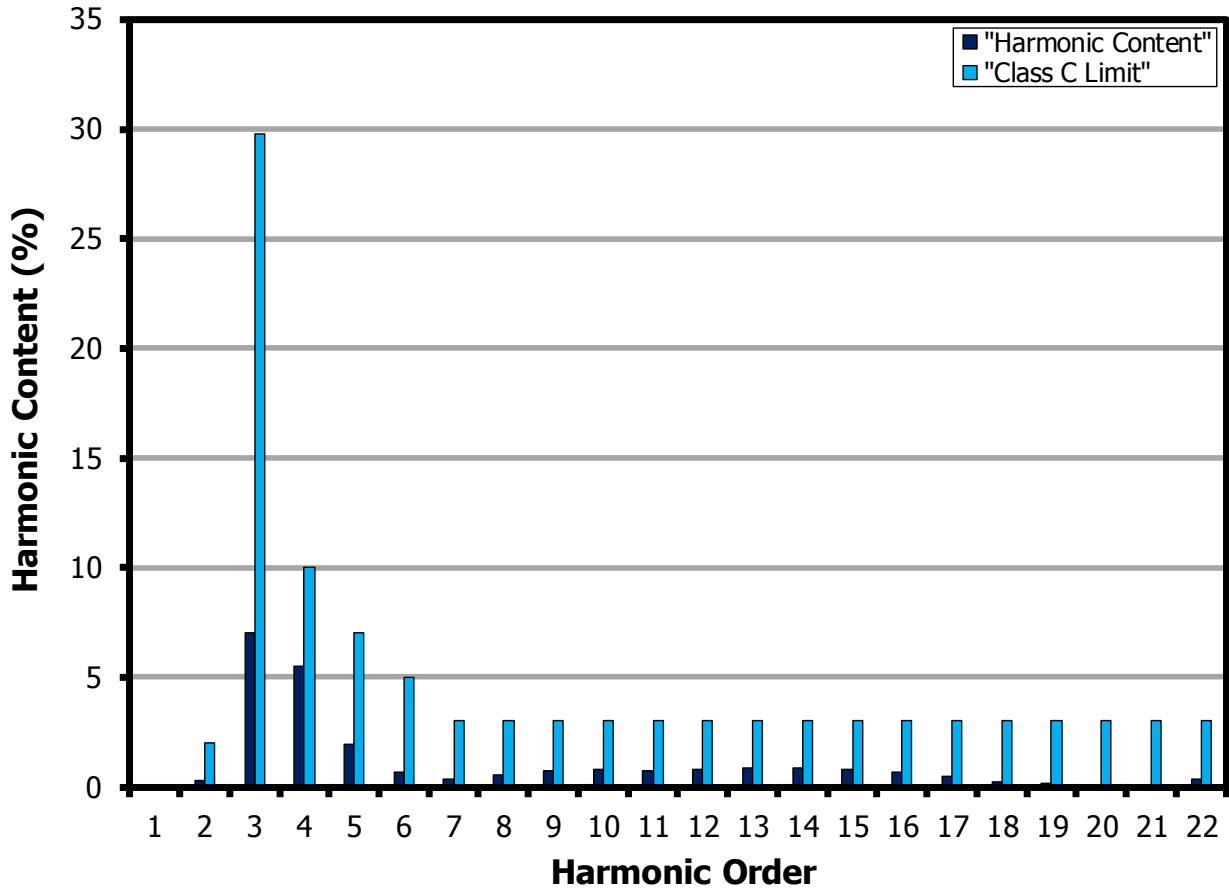

Figure 18 – Full Load Input Current Harmonics at 115 VAC 60 Hz.



10.5.2 High Line

Set-up: Open frame unit.
Load: 48 V 1350 mA LED load.
VIN: 230 V 50 Hz.
Ambient Temperature: 25 °C.
Soak Time: 10 minutes.

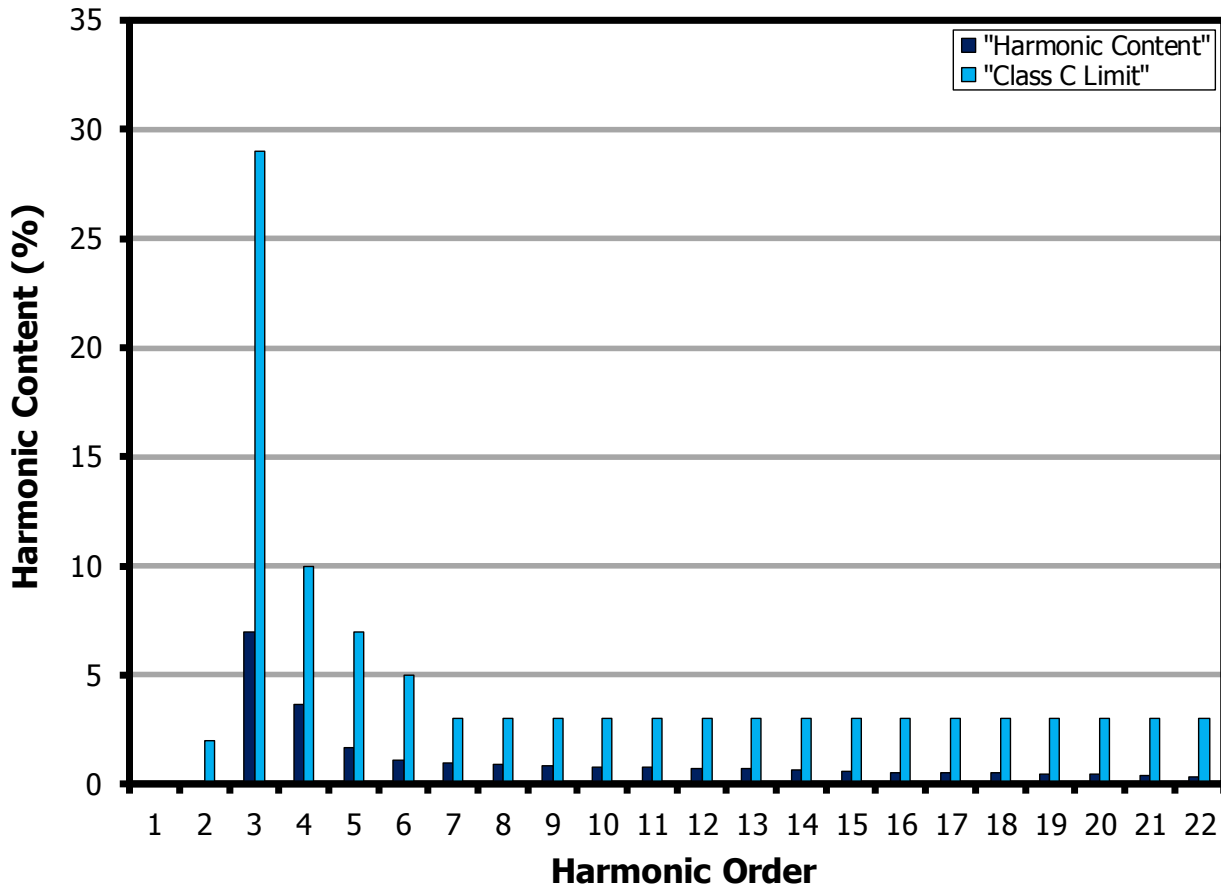

Figure 19 – Full Load Input Current Harmonics at 230 VAC 50 Hz.

10.6 No-Load Input Power

Set-up:	Open frame unit.
Load:	Open load.
Ambient Temperature:	25 °C.
Soak Time:	60 seconds.
Integration Time:	3 minutes.

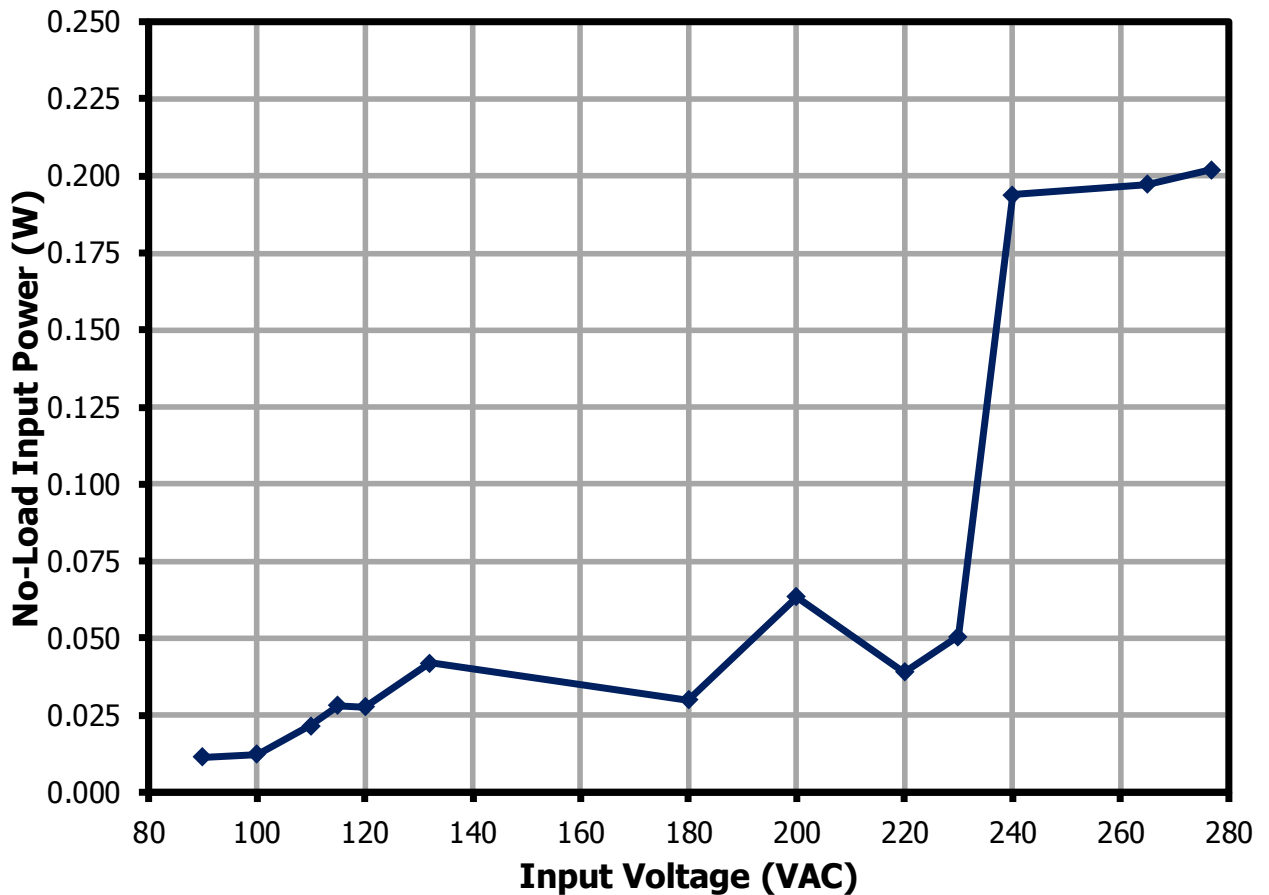

Figure 20 – No-Load Input Power vs. Input Line Voltage.

10.7 CV/CC Curve (for Non-Dimming Applications Only)

Set-up: Open frame unit.
Load: E-Load in CR mode.
Ambient Temperature: 25 °C.

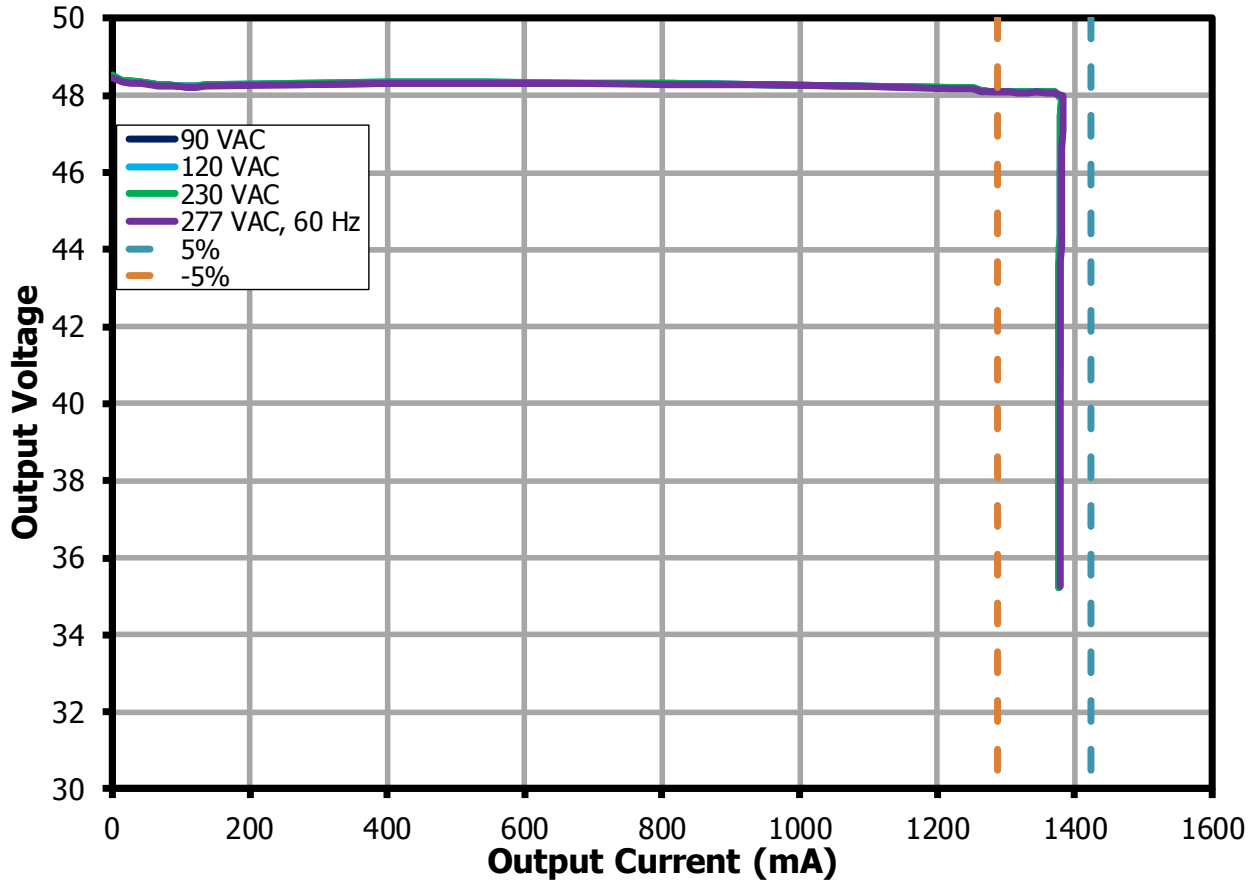

Figure 21 – CV/CC Curve.

10.8 Dimming Performance: 3-in-1 Dimming

Set-up: Open frame unit.
Load: 36 - 48 V 1350 mA LED load.
Ambient Temperature: 25 °C.

10.8.1 Variable Supply Dimming

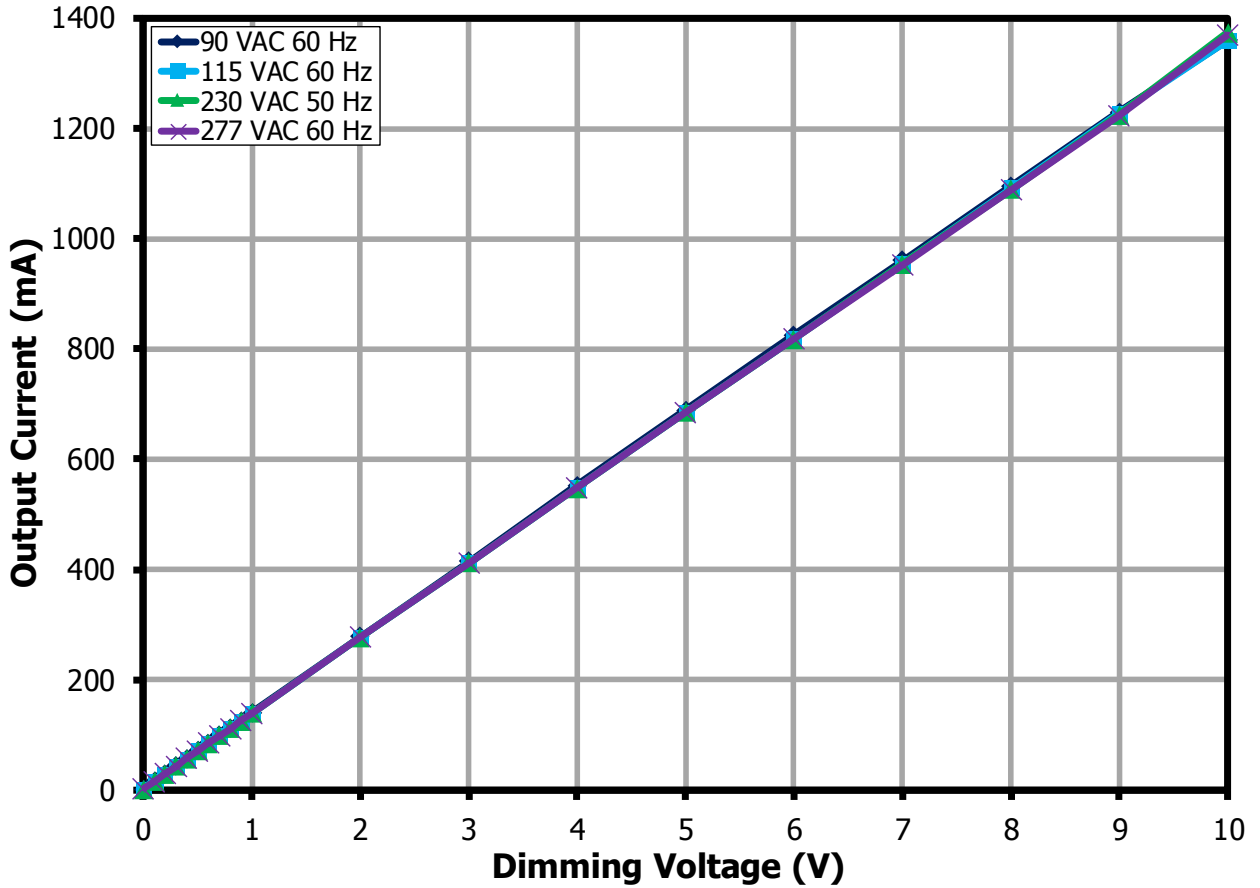

Figure 22 – Dimming Performance vs. Variable Supply (0 – 10 V)



10.8.2 Variable Resistor Dimming

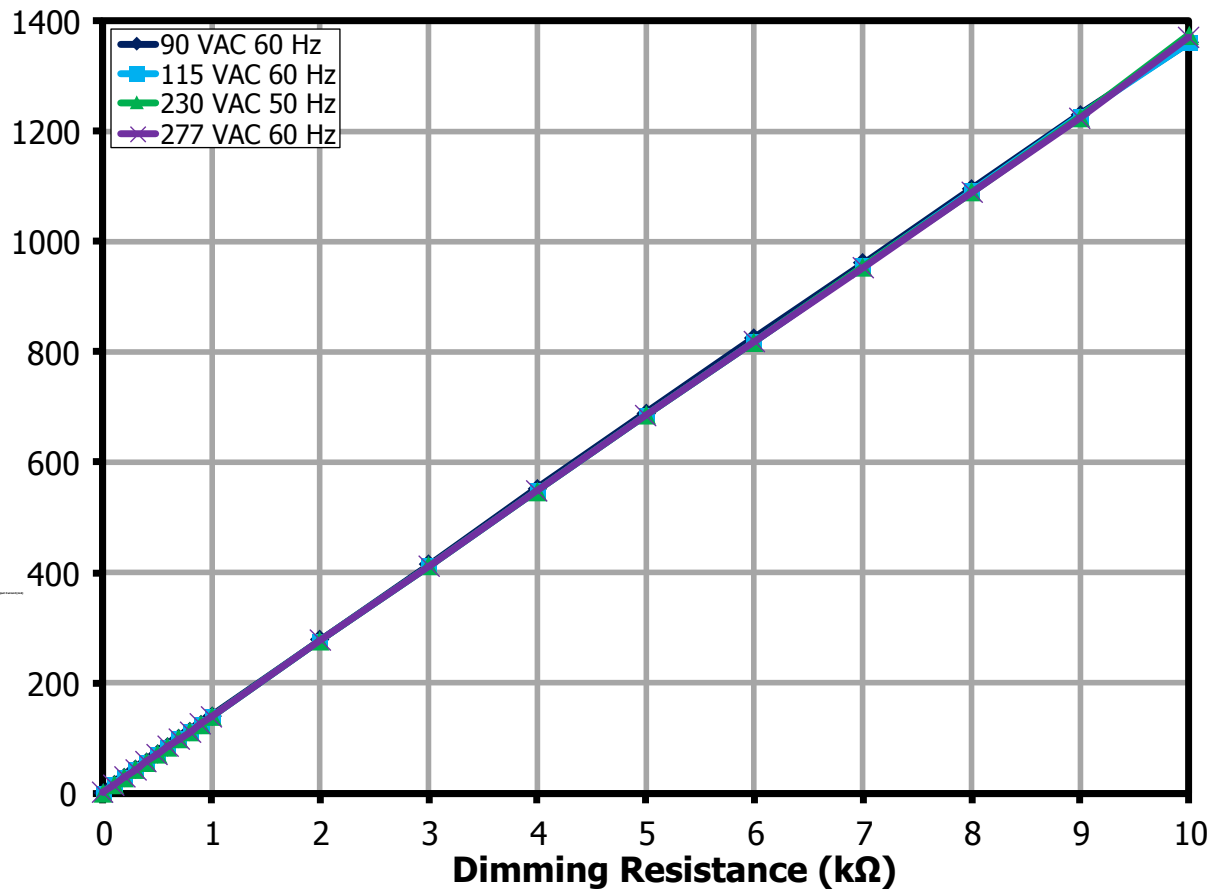

Figure 23 – Dimming Performance vs. Variable Resistor (0 – 100 kΩ)

10.8.3 Variable Duty PWM Dimming

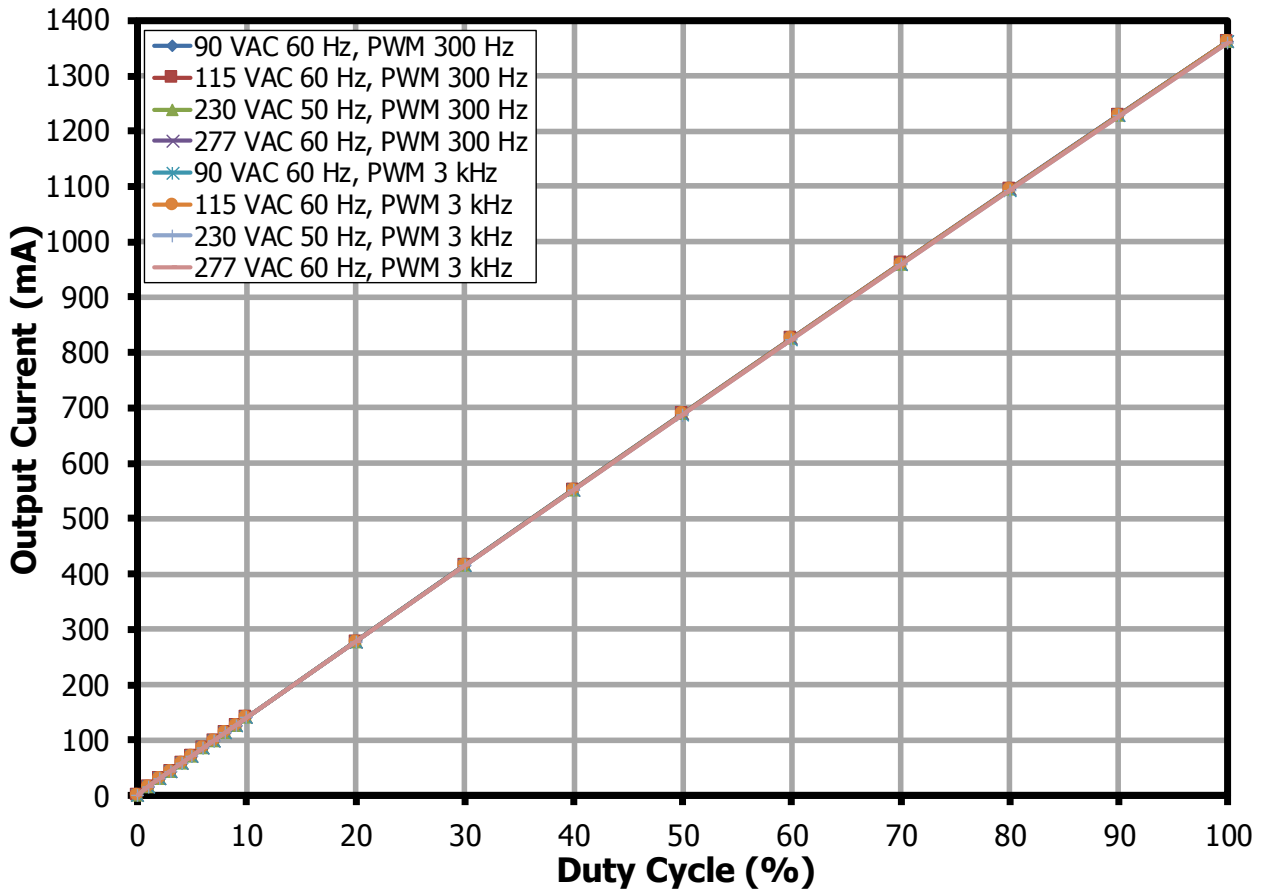

Figure 24 – Dimming Performance vs. Variable Duty PWM (300 Hz – 3 kHz)



11 Test Data

11.1 36 V Output

Input		Input Measurement					LED Load Measurement			Efficiency (%)
VAC (V _{RMS})	Freq (Hz)	V _{IN} (V _{RMS})	I _{IN} (mA _{RMS})	P _{IN} (W)	PF	%ATHD	V _{OUT} (V _{DC})	I _{OUT} (A _{DC})	P _{OUT} (W)	
90	60	89.8	650	57.6	0.987	12.0	36.5	1.37	49.9	86.6
100	60	99.8	580	57.2	0.988	12.8	36.5	1.37	49.8	87.1
110	60	110	528	57.1	0.986	14.3	36.4	1.37	49.8	87.2
115	60	115	505	57.0	0.984	15.2	36.4	1.37	49.8	87.3
120	60	120	483	56.9	0.982	16.0	36.4	1.37	49.7	87.5
132	60	132	436	56.4	0.980	16.4	36.4	1.37	49.7	88.2
180	50	180	322	55.9	0.966	18.0	36.4	1.37	49.7	88.8
200	50	200	282	55.8	0.988	9.37	36.3	1.37	49.6	89.0
220	50	220	259	56.0	0.982	10.2	36.3	1.37	49.6	88.6
230	50	230	248	55.9	0.978	10.8	36.3	1.37	49.6	88.7
240	50	240	239	55.8	0.973	10.8	36.3	1.37	49.5	88.9
265	50	265	220	55.6	0.952	10.5	36.3	1.37	49.5	89.2
277	60	277	221	55.4	0.905	12.9	36.3	1.37	49.5	89.3

11.2 42 V Output

Input		Input Measurement					LED Load Measurement			Efficiency (%)
VAC (V _{RMS})	Freq (Hz)	V _{IN} (V _{RMS})	I _{IN} (mA _{RMS})	P _{IN} (W)	PF	%ATHD	V _{OUT} (V _{DC})	I _{OUT} (A _{DC})	P _{OUT} (W)	
90	60	89.7	743	66.3	0.994	6.88	42.2	1.36	57.4	86.6
100	60	99.8	664	65.7	0.992	9.48	42.1	1.36	57.4	87.3
110	60	110	599	65.1	0.989	12.2	42.1	1.36	57.3	88.1
115	60	115	571	64.8	0.989	12.5	42.1	1.36	57.2	88.3
120	60	120	547	64.7	0.988	12.9	42.0	1.36	57.2	88.3
132	60	132	499	64.7	0.984	14.4	42.0	1.36	57.1	88.3
180	50	180	365	63.9	0.973	15.9	42.0	1.36	57.1	89.3
200	50	200	321	63.5	0.991	8.94	42.0	1.36	57.1	89.8
220	50	220	293	63.5	0.987	8.95	42.0	1.36	57.0	89.8
230	50	230	281	63.6	0.984	9.96	41.9	1.36	57.0	89.6
240	50	240	270	63.6	0.981	10.2	41.9	1.36	57.0	89.6
265	50	265	248	63.3	0.964	9.86	41.9	1.36	56.9	89.9
277	60	277	246	63.2	0.926	12.1	41.9	1.36	56.9	90.0



11.3 48 V Output

Input		Input Measurement					LED Load Measurement			Efficiency (%)
VAC (V _{RMS})	Freq (Hz)	V _{IN} (V _{RMS})	I _{IN} (mA _{RMS})	P _{IN} (W)	PF	%ATHD	V _{OUT} (V _{DC})	I _{OUT} (A _{DC})	P _{OUT} (W)	
90	60	89.8	831	74.3	0.996	4.06	47.6	1.36	64.5	86.8
100	60	99.8	742	73.7	0.995	5.91	47.6	1.36	64.4	87.4
110	60	110	671	73.2	0.994	7.75	47.5	1.35	64.4	88.0
115	60	115	640	72.9	0.993	9.00	47.5	1.35	64.3	88.2
120	60	120	612	72.7	0.992	9.99	47.5	1.35	64.3	88.5
132	60	132	553	72.0	0.988	12.8	47.5	1.35	64.3	89.2
180	50	180	406	71.4	0.978	14.4	47.5	1.35	64.2	90.0
200	50	200	364	71.4	0.981	7.24	47.4	1.35	64.2	89.9
220	50	220	332	71.0	0.973	8.17	47.4	1.35	64.2	90.4
230	50	230	318	70.9	0.968	8.41	47.4	1.35	64.1	90.5
240	50	240	307	70.9	0.962	9.37	47.4	1.35	64.1	90.4
265	50	265	284	70.9	0.941	10.7	47.4	1.35	64.1	90.5
277	60	277	272	70.7	0.941	11.0	47.4	1.35	64.1	90.6

11.4 Test Data at No-Load

Input				
VAC (V _{RMS})	Freq (Hz)	V _{IN} (V _{RMS})	I _{IN} (mA _{RMS})	P _{IN} (mW)
90	60	90.0	16.1	11.5
100	60	100	17.5	12.3
110	60	110	18.8	21.5
115	60	115	19.5	28.2
120	60	120	20.1	27.8
132	60	132	21.7	42.0
180	50	180	24.2	30.0
200	50	200	26.1	63.4
220	50	220	28.2	39.1
230	50	230	29.2	50.6
240	50	240	33.0	194
265	50	265	32.7	197
277	60	277	40.2	202

11.5 Individual Harmonic Content at 115 VAC 60 Hz and Full Load

V	Freq	I (mA)	P	PF	%THD
115	60	642	73.2	0.993	9.23
nth Order	mA Content	% Content	Limit <25 W	Limit >25 W	Remarks
1	637				
2	2.00	0.31		2.00	pass
3	44.6	7.00	249	29.8	pass
5	35.2	5.52	139	10.0	pass
7	12.2	1.92	73.2	7.00	pass
9	4.40	0.69	36.6	5.00	pass
11	2.20	0.35	25.6	3.00	pass
13	3.60	0.57	21.7	3.00	pass
15	4.80	0.75	18.8	3.00	pass
17	5.20	0.82	16.6	3.00	pass
19	4.70	0.74	14.8	3.00	pass
21	5.10	0.80	13.4	3.00	pass
23	5.60	0.88	12.3	3.00	pass
25	5.60	0.88	11.3	3.00	pass
27	5.20	0.82	10.4	3.00	pass
29	4.20	0.66	9.71	3.00	pass
31	2.90	0.46	9.09	3.00	pass
33	1.60	0.25	8.53	3.00	pass
35	1.00	0.16	8.05	3.00	pass
37	0.70	0.11	7.61	3.00	pass
39	0.80	0.13	7.22	3.00	pass
41	2.10	0.33	6.87	3.00	pass

11.6 Individual Harmonic Content at 230 VAC 50 Hz and Full Load

V	Freq	I (mA)	P	PF	%THD
230	50	320	71.2	0.968	8.59
nth Order	mA Content	% Content	Limit <25 W	Limit >25 W	Remarks
1	318				
2	0.14	0.04		2.00	pass
3	22.3	6.99	242	29.0	pass
5	11.6	3.65	135	10.0	pass
7	5.39	1.69	71.2	7.00	pass
9	3.48	1.09	35.6	5.00	pass
11	3.11	0.98	24.9	3.00	pass
13	2.88	0.91	21.0	3.00	pass
15	2.66	0.84	18.3	3.00	pass
17	2.43	0.76	16.1	3.00	pass
19	2.55	0.80	14.4	3.00	pass
21	2.34	0.74	13.1	3.00	pass
23	2.31	0.73	11.9	3.00	pass
25	2.11	0.66	11.0	3.00	pass
27	1.97	0.62	10.2	3.00	pass
29	1.72	0.54	9.45	3.00	pass
31	1.76	0.55	8.84	3.00	pass
33	1.68	0.53	8.30	3.00	pass
35	1.47	0.46	7.83	3.00	pass
37	1.49	0.47	7.40	3.00	pass
39	1.30	0.41	7.03	3.00	pass
41	1.12	0.35	6.68	3.00	pass

12 Thermal Performance

12.1 Thermal Measurements at Ambient Room Temperature

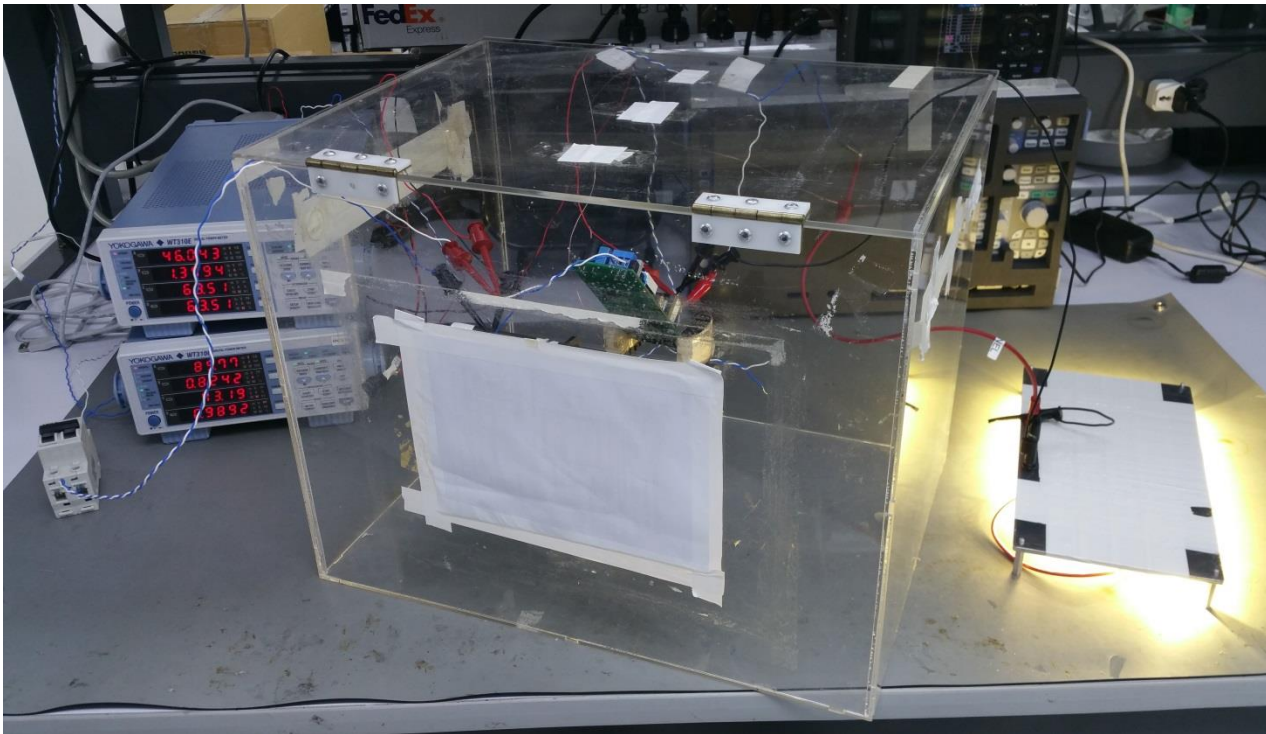

Figure 25 – Test Set-up Picture - Open Frame.

Unit in open frame was placed inside the acrylic enclosure to prevent airflow that might affect the thermal measurements. Temperature was measured using FLIR E60 thermal camera.

Equipment used:

1. KEYSIGHT 6812B AC Power Source/Analyzer
2. Chroma 63110A DC Electronic Load Mainframe
3. FLIR E60 Thermal Camera
4. Yokogawa WT310E Digital Power Meter

12.2 Thermal Results

Ref Des	Description	Temperature Reading (°C)			
		90 VAC 60 Hz	120 VAC 60 Hz	230 VAC 50 Hz	277 VAC 60 Hz
BR1	Bridge Diode	92	76	56	55
RT1	Input Thermistor	83	69	50	48
U2	HiperPFS-4	84	61	59	66
D5	PFC Output Diode	72	62	58	60
T2 Wire	PFC Inductor Winding	90	80	67	63
T2 Core	PFC Inductor Core	76	66	57	56
U4	LYTSwitch-6	76	74	73	74
D12	Output Diode	76	75	75	75
D4	Output Diode	74	73	73	74
T3 Wire	DCDC Main Transformer Winding	76	74	74	75
T3 Core	DCDC Main Transformer Core	68	67	66	67
D3	DCDC Primary Snubber Clamp Diode	66	64	64	65
R6	Output Diode Snubber Resistor	77	77	77	76
AMBIENT		30			

12.3 90 VAC

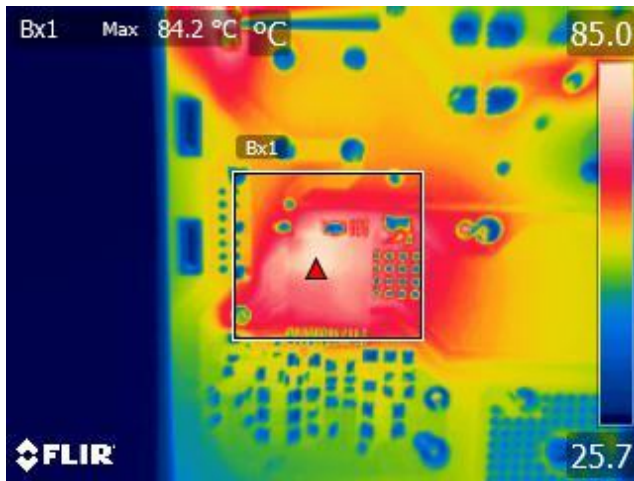

Figure 26 – HiperPFS-4 (U2).

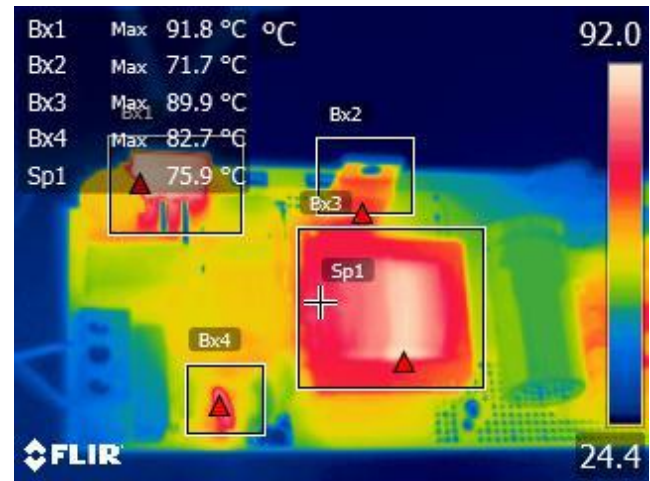

Figure 27 – **Bx1** – Bridge Diode (BR1);
Bx2 – PFC Output Diode (D5).
Bx3 – PFC Inductor Winding (T2 Wire).
Bx4 – Input Thermistor (RT1).
Sp1 – PFC Inductor Core (T2 Core).

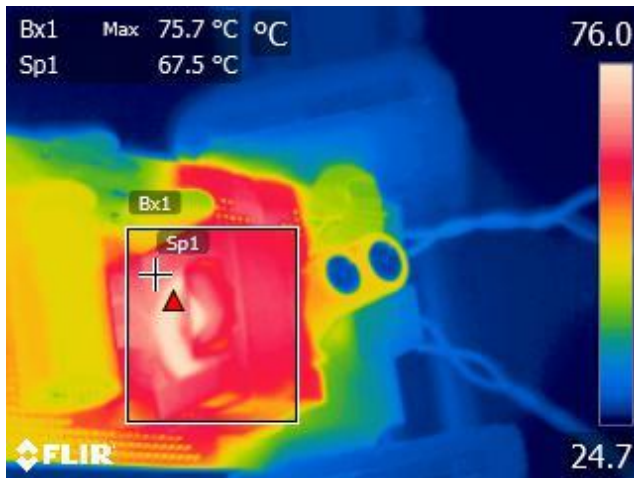

Figure 28 – **Bx1** – DCDC Main Transformer Winding (T3 Wire).
Sp1 – DCDC Main Transformer Core (T3 Core).

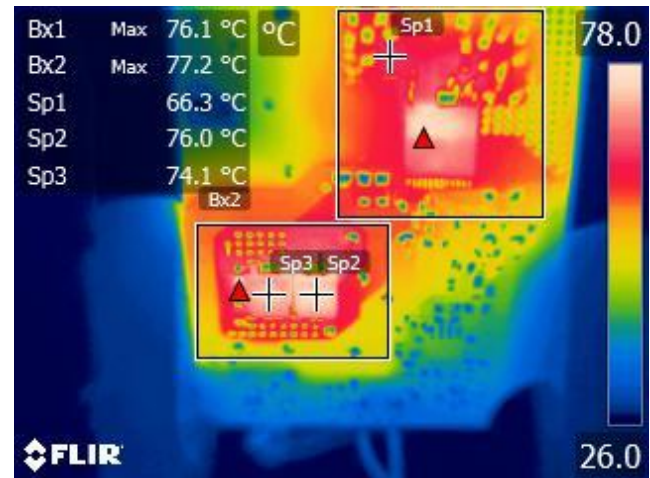

Figure 29 – **Bx1** – LYTSwitch-6 (U4).
Bx2 – Output Diode Snubber Resistor (R6).
Sp1 – DCDC Primary Snubber Clamp Diode (D3).
Sp2 – Output Diode (D12).
Sp3 – Output Diode (D4).

12.4 120 VAC

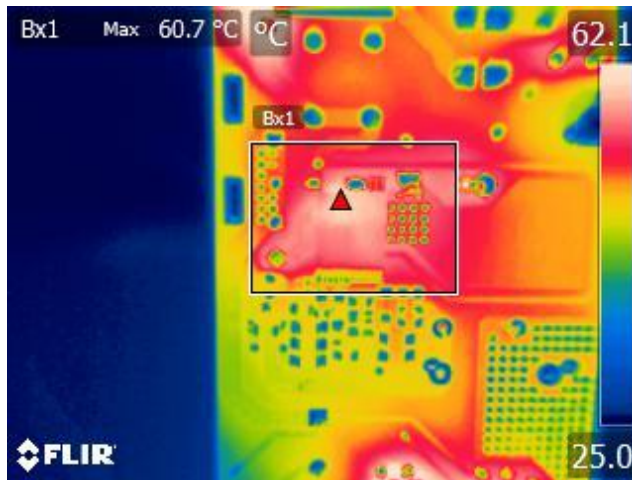

Figure 30 – HiperPFS-4 (U2).

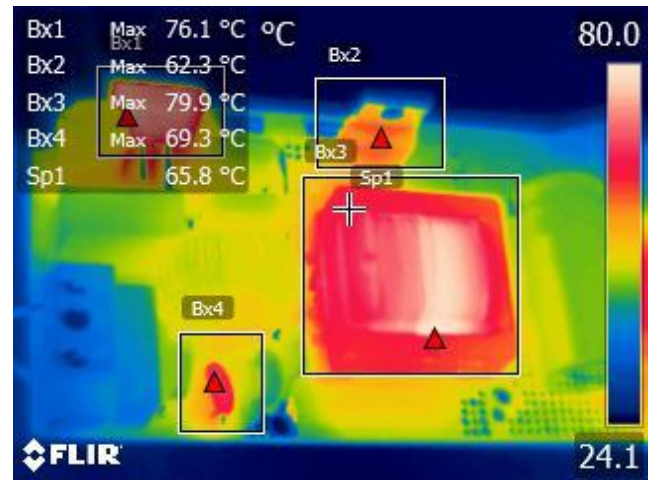

Figure 31 – **Bx1** – Bridge Diode (BR1).
Bx2 – PFC Output Diode (D5).
Bx3 – PFC Inductor Winding (T2 Wire).
Bx4 – Input Thermistor (RT1).
Sp1 – PFC Inductor Core (T2 Core).

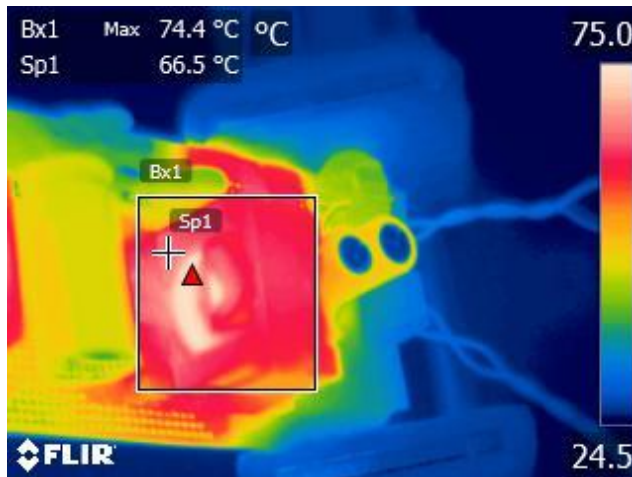

Figure 32 – **Bx1** – DCDC Main Transformer Winding (T3 Wire).
Sp1 – DCDC Main Transformer Core (T3 Core).

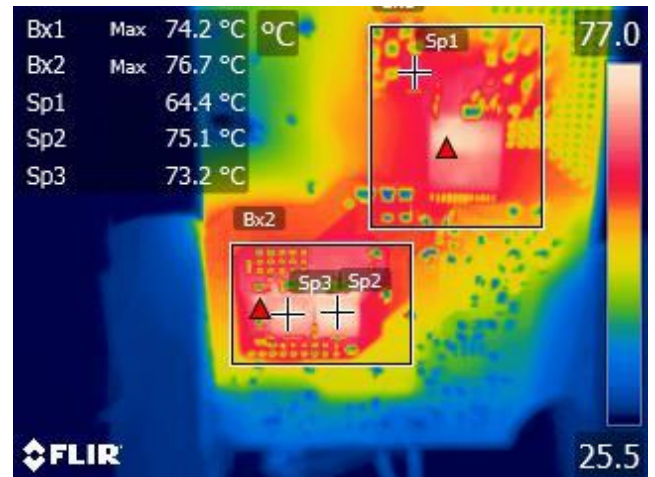

Figure 33 – **Bx1** – LYTSwitch-6 (U4).
Bx2 – Output Diode Snubber Resistor (R6).
Sp1 – DCDC Primary Snubber Clamp Diode (D3).
Sp2 – Output Diode (D12).
Sp3 – Output Diode (D4).

12.5 230 VAC

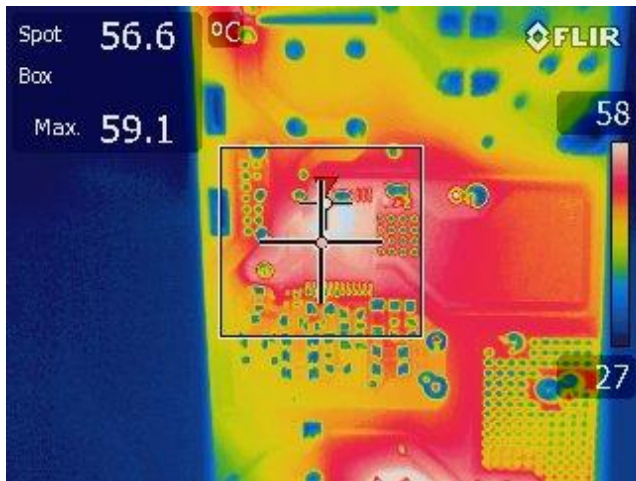

Figure 34 – HiperPFS-4 (U2).

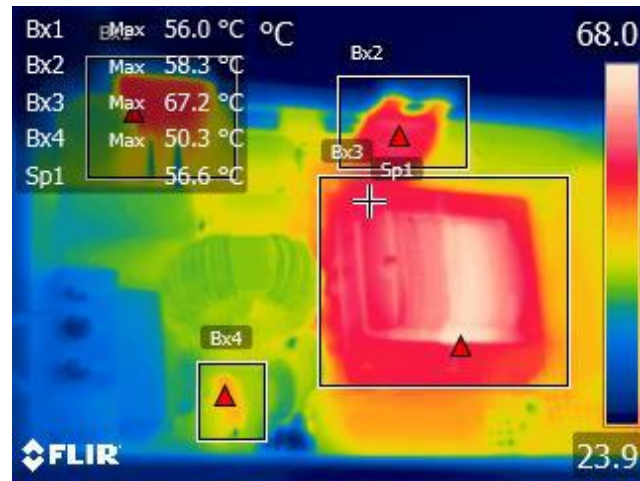

Figure 35 – **Bx1** – Bridge Diode (BR1).
Bx2 – PFC Output Diode (D5).
Bx3 – PFC Inductor Winding (T2 Wire).
Bx4 – Input Thermistor (RT1).
Sp1 – PFC Inductor Core (T2 Core).

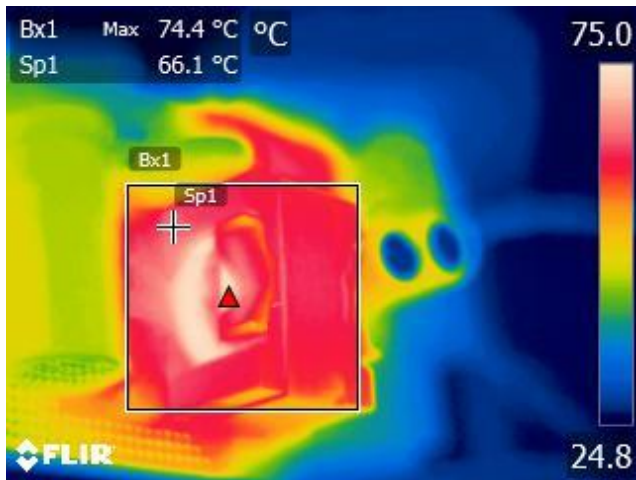

Figure 36 – **Bx1** – DCDC Main Transformer Winding (T3 Wire).
Sp1 – DCDC Main Transformer Core (T3 Core).

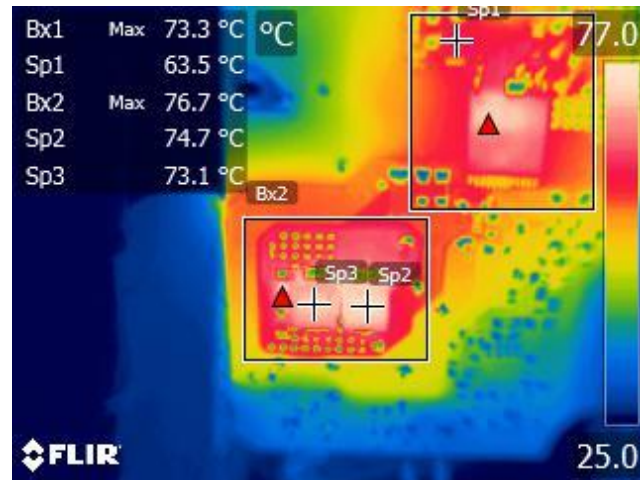

Figure 37 – **Bx1** – LYTSwitch-6 (U4).
Bx2 – Output Diode Snubber Resistor (R6).
Sp1 – DCDC Primary Snubber Clamp Diode (D3).
Sp2 – Output Diode (D12).
Sp3 – Output Diode (D4).

12.6 277 VAC

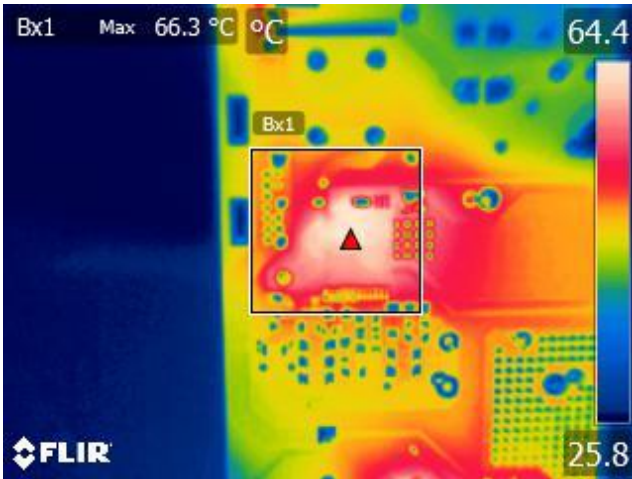

Figure 38 – HiperPFS-4 (U2).

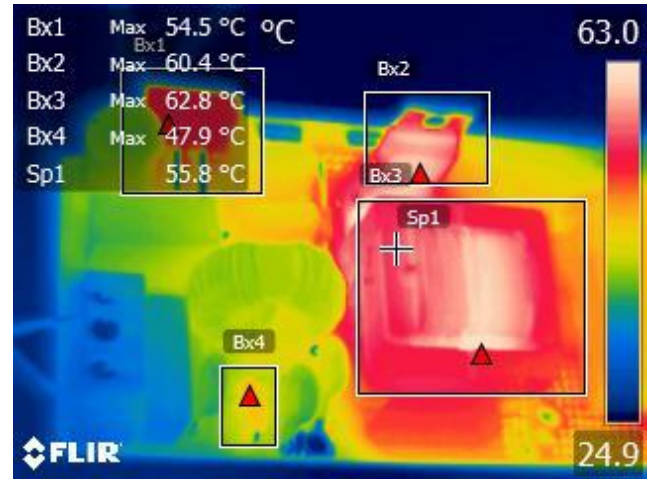

Figure 39 – **Bx1** – Bridge Diode (BR1).
Bx2 – PFC Output Diode (D5).
Bx3 – PFC Inductor Winding (T2 Wire).
Bx4 – Input Thermistor (RT1).
Sp1 – PFC Inductor Core (T2 Core).

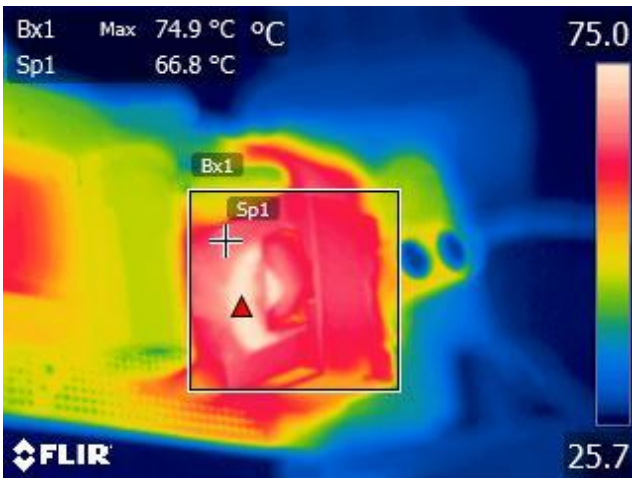

Figure 40 – **Bx1** – DCDC Main Transformer Winding (T3 Wire).
Sp1 – DCDC Main Transformer Core (T3 Core).

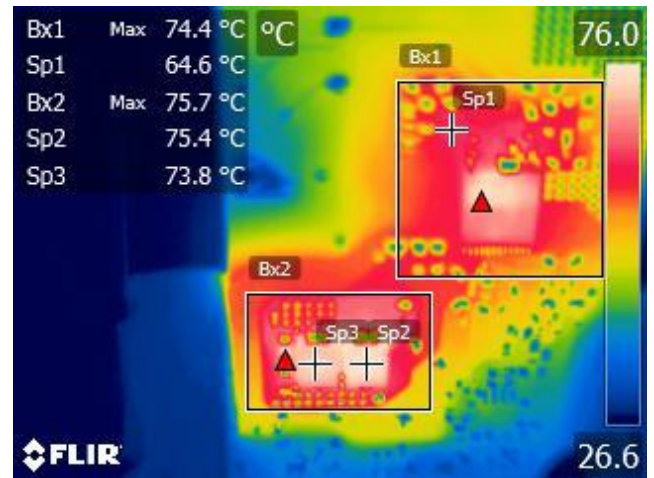

Figure 41 – **Bx1** – LYTSwitch-6 (U4).
Bx2 – Output Diode Snubber Resistor (R6).
Sp1 – DCDC Primary Snubber Clamp Diode (D3).
Sp2 – Output Diode (D12).
Sp3 – Output Diode (D4).

12.7 Thermal Performance at High Ambient Temperature

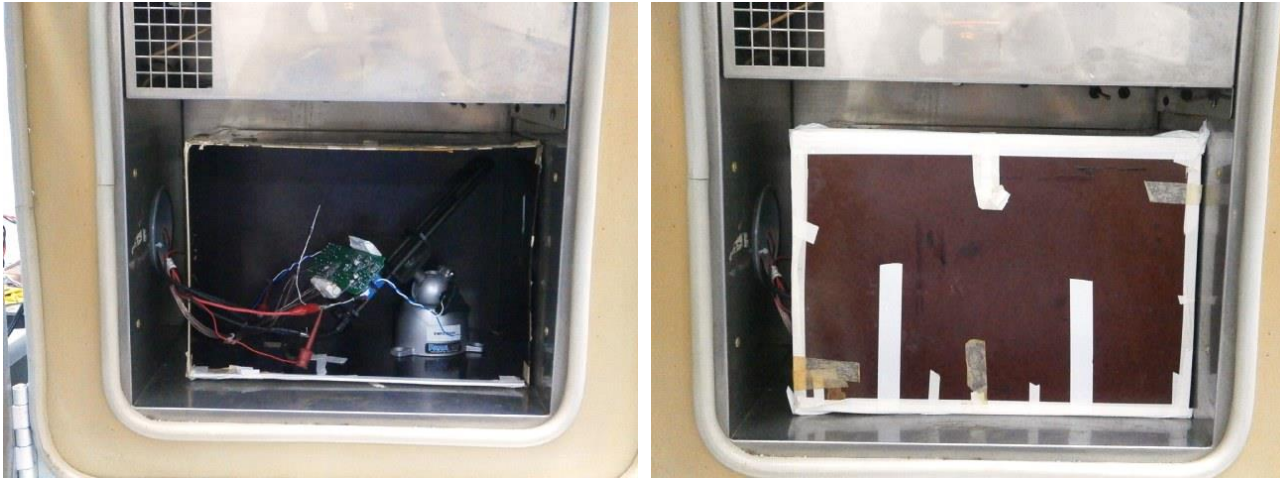

Figure 42 – Test Set-up Picture Thermal at 55 °C Ambient - Open Frame.

Open frame unit was placed inside the enclosure to prevent airflow that may affect the thermal measurements. Ambient temperature inside the enclosure is set at 55 °C. Temperature was measured using T-type thermocouple. Soak time at full load is more than 2 hours.

Equipment used:

1. KEYSIGHT 6812B AC Power Source/Analyzer
2. Yokogawa Data Logger
3. Yokogawa WT310 Digital Power Meter
4. SPX Tenney TUJR Thermal Chamber

Ref Des	Description	Temperature Reading (°C)	
		90 VAC 60 Hz	277 VAC 60 Hz
BR1	Bridge Diode	99	71
U2	HiperPFS-4	101	81
D5	PFC Output Diode	84	75
T2 Wire	PFC Inductor Winding	104	80
T2 Core	PFC Inductor Core	90	73
U4	LYTSwitch-6	116	118
D12	Output Diode	92	97
D4	Output Diode	93	98
T3 Wire	DCDC Main Transformer Winding	87	89
T3 Core	DCDC Main Transformer Core	83	85
D3	DCDC Primary Snubber Clamp Diode	90	90
R6	Output Diode Snubber Resistor	89	94
AMBIENT		55	

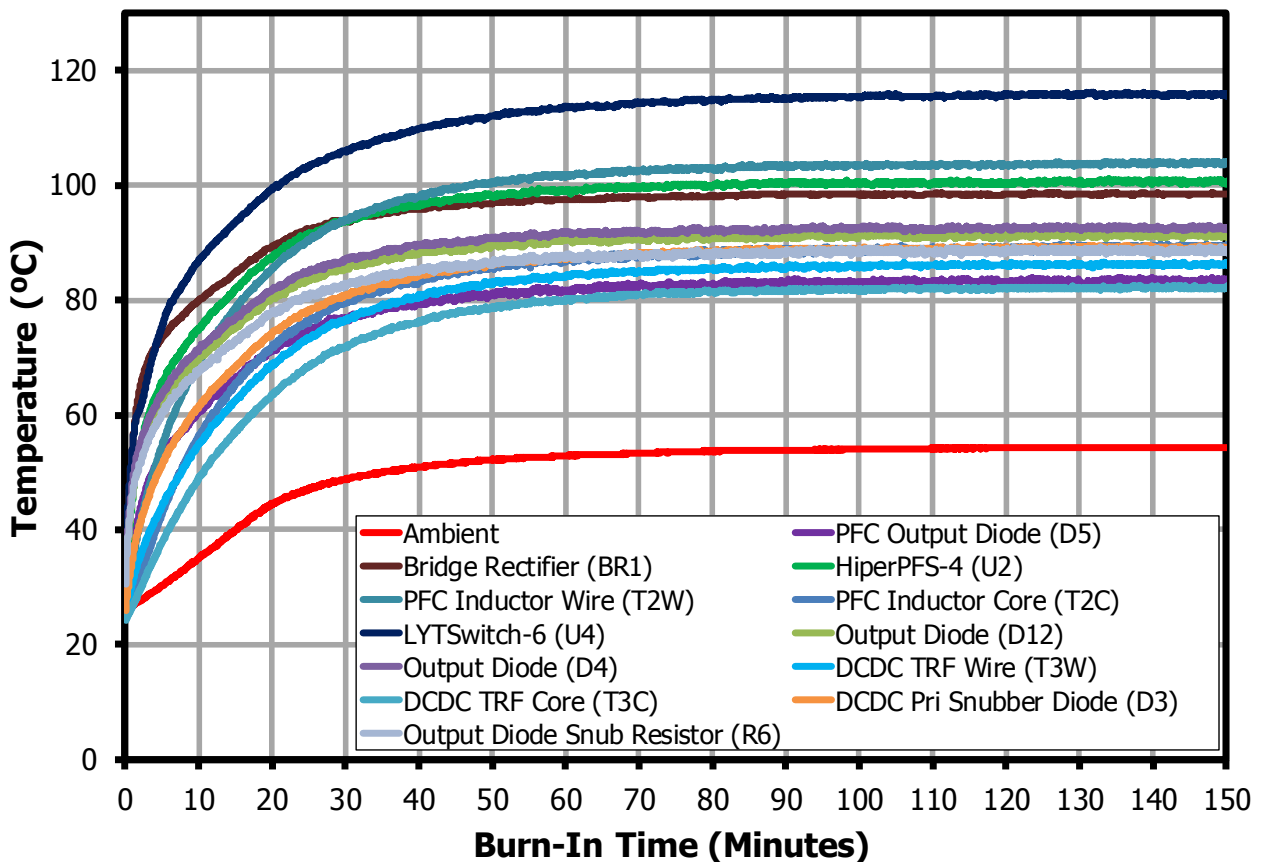

Figure 43 – Component Temperature at 55 °C Ambient - Open Frame (Low Line – 90 VAC).



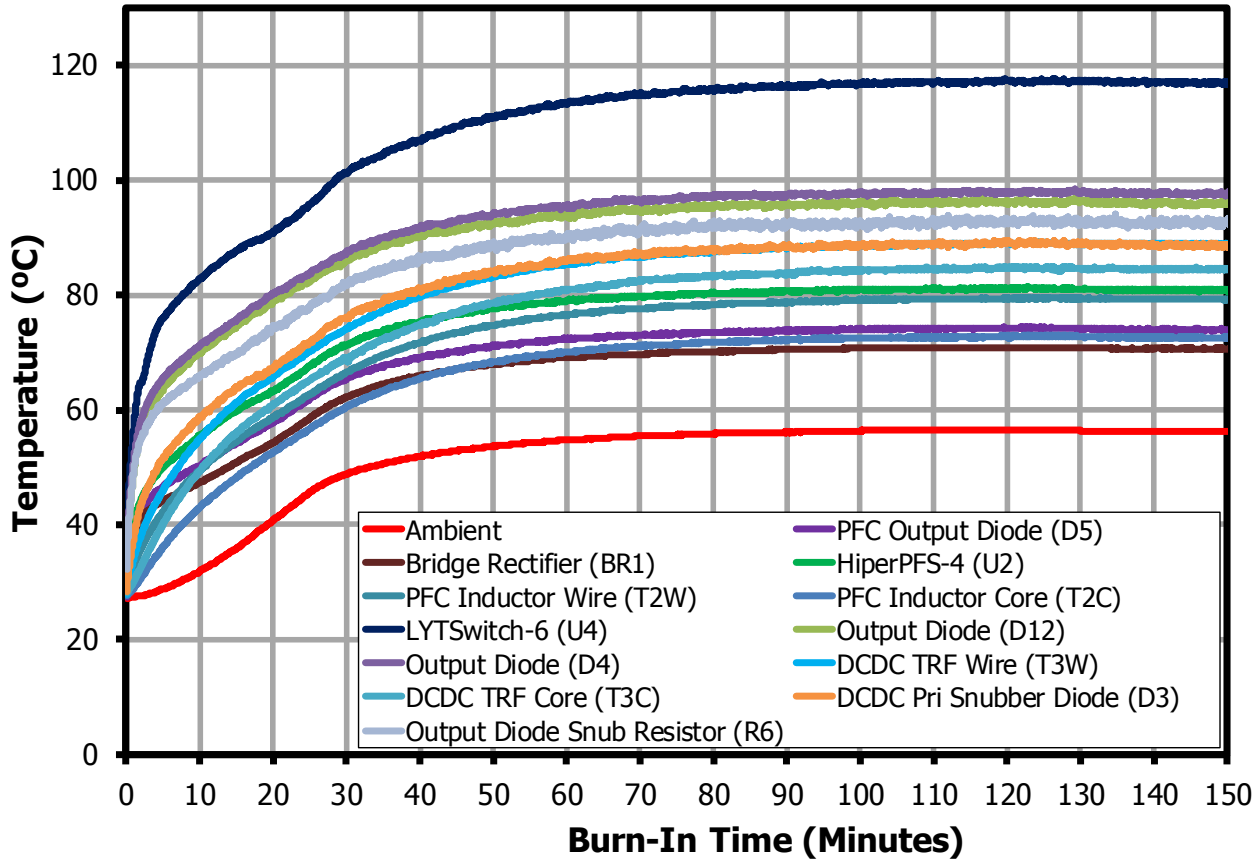

Figure 44 – Component Temperature at 55 °C Ambient - Open Frame (High Line – 277 VAC).

13 Waveforms

Waveforms were taken at room temperature (25 °C).

13.1 Input Voltage and Input Current at Full Load

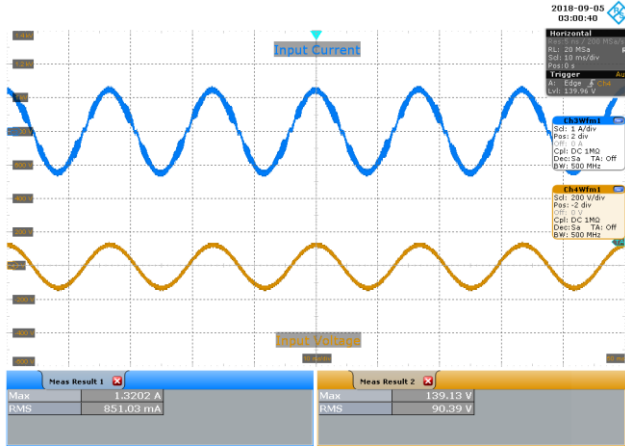

Figure 45 – 90 VAC 60 Hz, Full Load.
Upper: I_{IN} , 1 A / div
Lower: V_{IN} , 200 V / div, 10 ms / div.

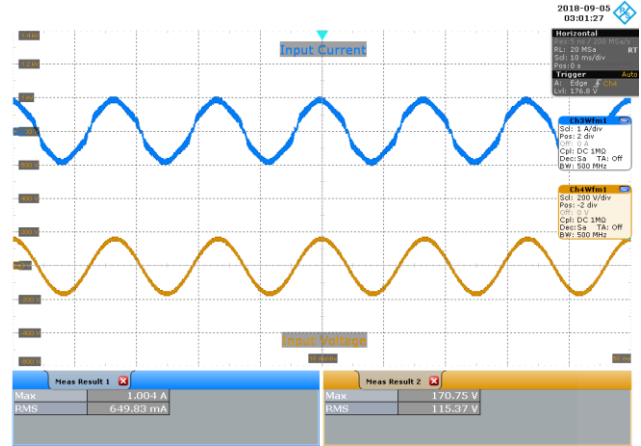

Figure 46 – 115 VAC 60 Hz, Full Load.
Upper: I_{IN} , 1 A / div.
Lower: V_{IN} , 200 V / div., 10 ms / div.

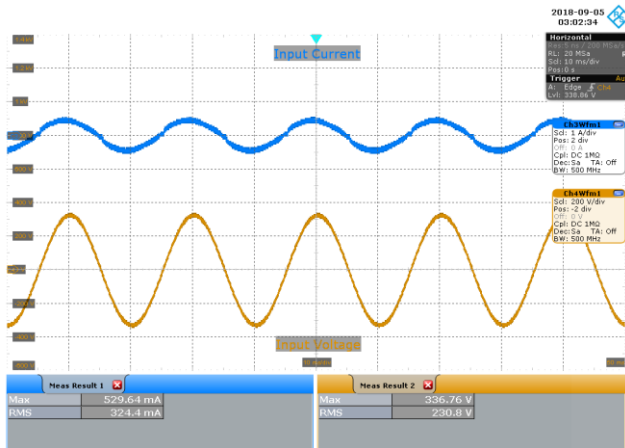

Figure 47 – 230 VAC 50 Hz, Full Load.
Upper: I_{IN} , 1 A / div.
Lower: V_{IN} , 200 V / div., 10 ms / div.

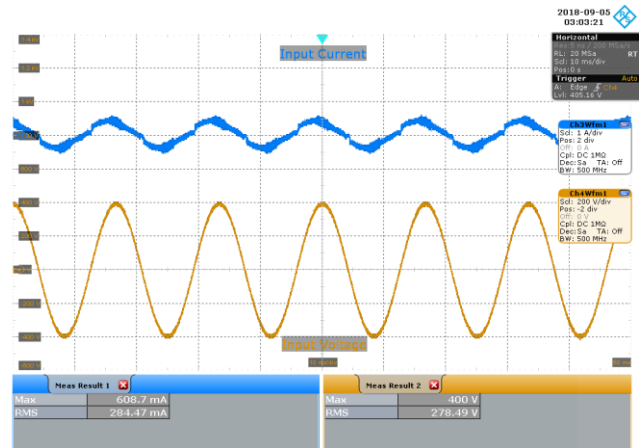

Figure 48 – 277 VAC 60 Hz, Full Load.
Upper: I_{IN} , 1 A / div.
Lower: V_{IN} , 200 V / div., 10 ms / div.

13.2 Start-up Profile at Full Load

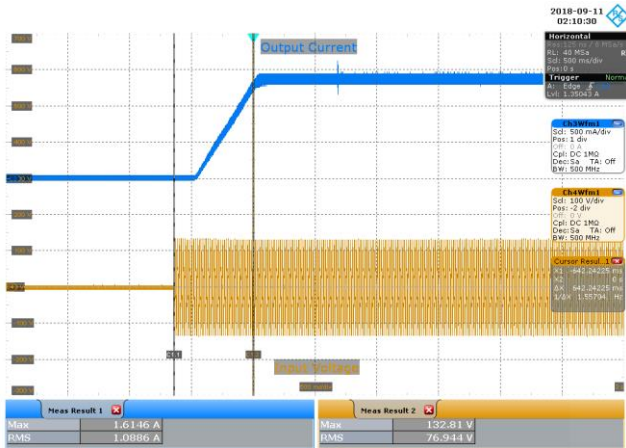

Figure 49 – 90 VAC 60 Hz, Full Load Start-up.
 Upper: I_{OUT} , 500 mA / div.
 Lower: V_{IN} , 100 V / div., 500 ms / div.
 Turn On Time: 642 ms.

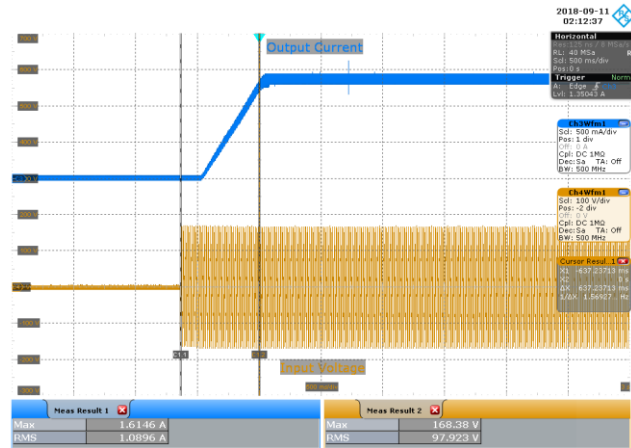

Figure 50 – 115 VAC 60 Hz, Full Load Start-up.
 Upper: I_{OUT} , 500 mA / div.
 Lower: V_{IN} , 100 V / div., 500 ms / div.
 Turn On Time: 637 ms.

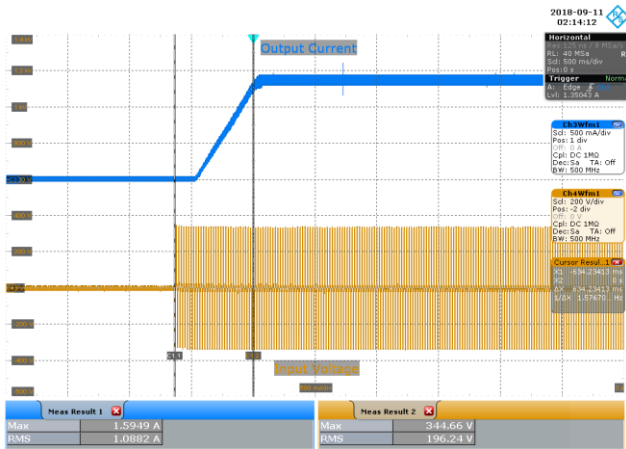

Figure 51 – 230 VAC 50 Hz, Full Load Start-up.
 Upper: I_{OUT} , 500 mA / div.
 Lower: V_{IN} , 200 V / div., 500 ms / div.
 Turn On Time: 634 ms.

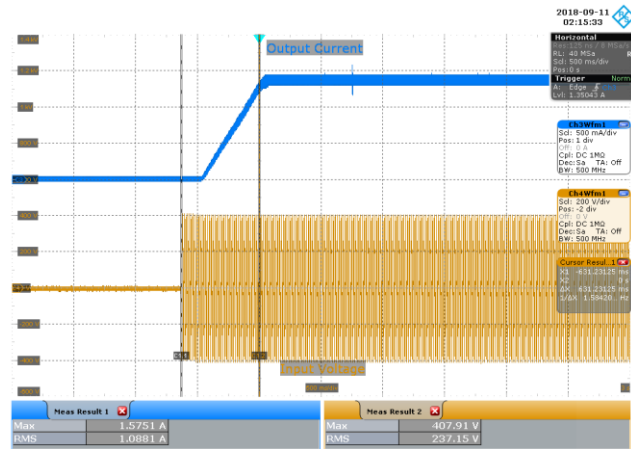

Figure 52 – 277 VAC 60 Hz, Full Load Start-up.
 Upper: I_{OUT} , 500 mA / div.
 Lower: V_{IN} , 200 V / div., 500 ms / div.
 Turn On Time: 631 ms.

13.3 Turn-Off Profile Full Load

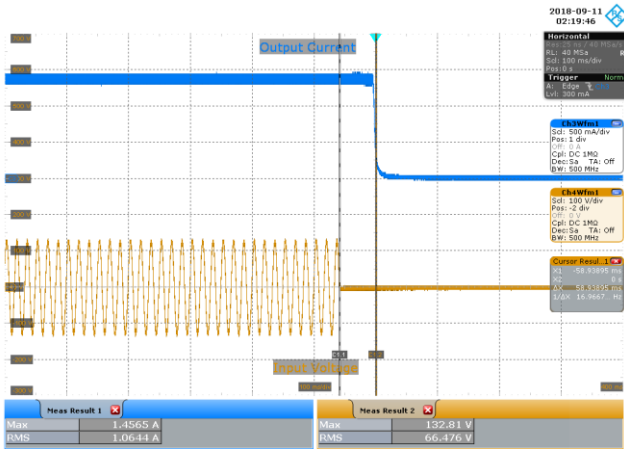

Figure 53 – 90 VAC 60 Hz, Full Load, Output Fall.
 Upper: I_{OUT} , 500 mA / div.
 Lower: V_{IN} , 100 V / div., 100 ms / div.
 Turn On Time: 59 ms.

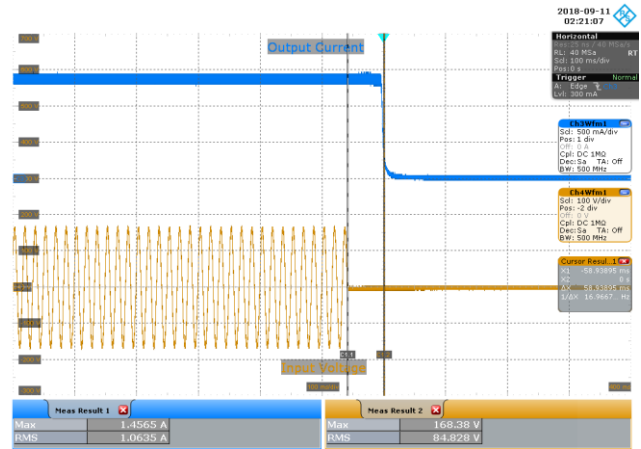

Figure 54 – 115 VAC 60 Hz, Full Load, Output Fall.
 Upper: I_{OUT} , 500 mA / Div
 Lower: V_{IN} , 100 V / div., 100 ms / div.
 Turn On Time: 59 ms.

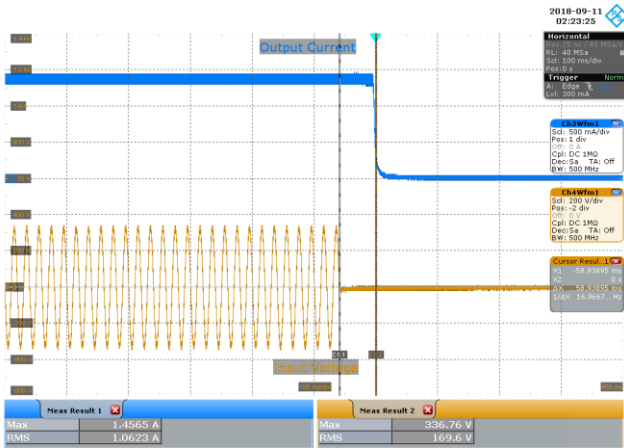

Figure 55 – 230 VAC 50 Hz, Full Load, Output Fall.
 Upper: V_{OUT} , 500 mA / div.
 Lower: V_{IN} , 200 V / div., 100 ms / div.
 Hold-up Time: 59 ms.

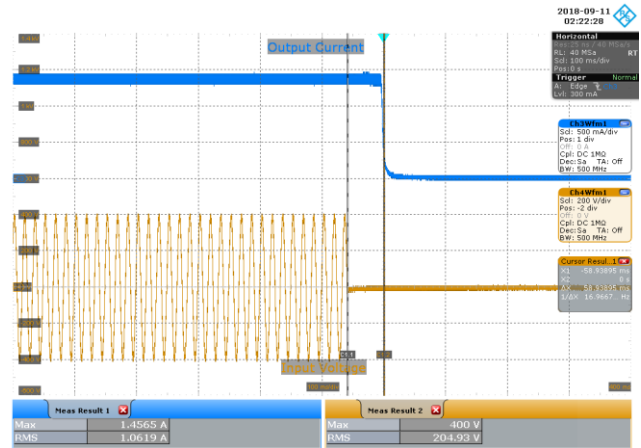

Figure 56 – 277 VAC 60 Hz, Full Load, Output Fall.
 Upper: V_{OUT} , 500 mA / div.
 Lower: V_{IN} , 200 V / div., 100 ms / div.
 Hold-up Time: 59 ms.



13.4 HiperPFS-4 Drain Voltage and Current Waveforms at Normal Operation

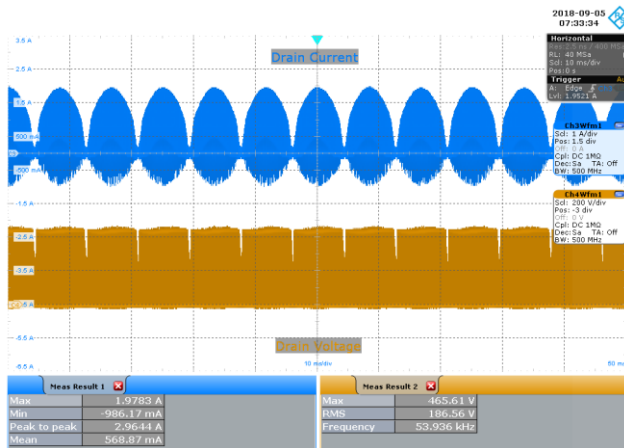

Figure 57 – 90 VAC 60 Hz, Full Load Normal.
Upper: I_{DRAIN} , 1 A / div.
Lower: V_{DRAIN} , 200 V / div., 10 ms / div.

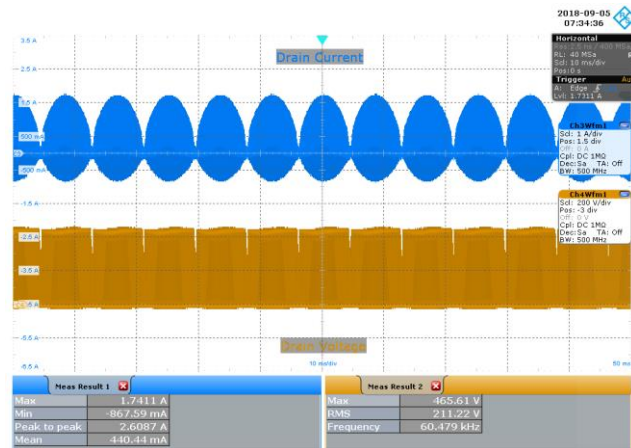

Figure 58 – 115 VAC 60 Hz, Full Load Normal.
Upper: I_{DRAIN} , 1 A / div.
Lower: V_{DRAIN} , 200 V / div., 10 ms / div.

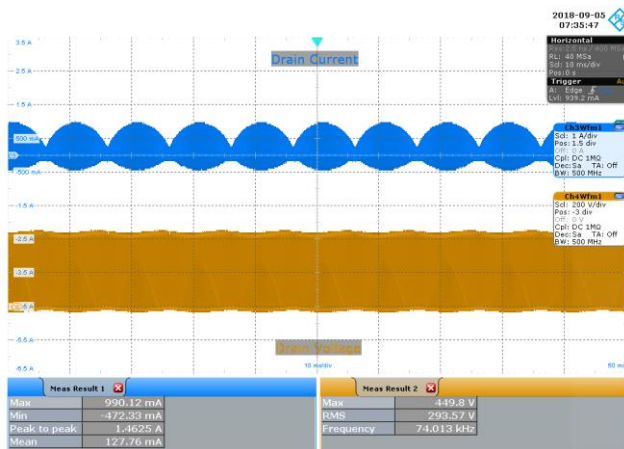

Figure 59 – 230 VAC 50 Hz, Full Load Normal.
Upper: I_{DRAIN} , 1 A / div.
Lower: V_{DRAIN} , 200 V / div., 10 ms / div.

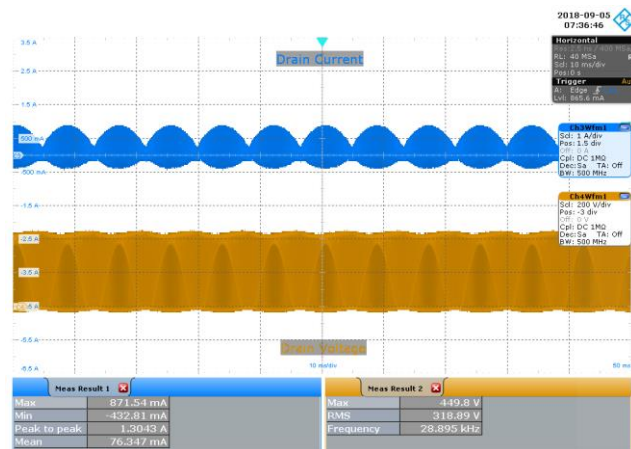

Figure 60 – 277 VAC 60 Hz, Full Load Normal.
Upper: I_{DRAIN} , 1 A / div.
Lower: V_{DRAIN} , 200 V / div., 10 ms / div.

13.5 HiperPFS-4 Drain Voltage and Current Waveforms at Full Load Start-up

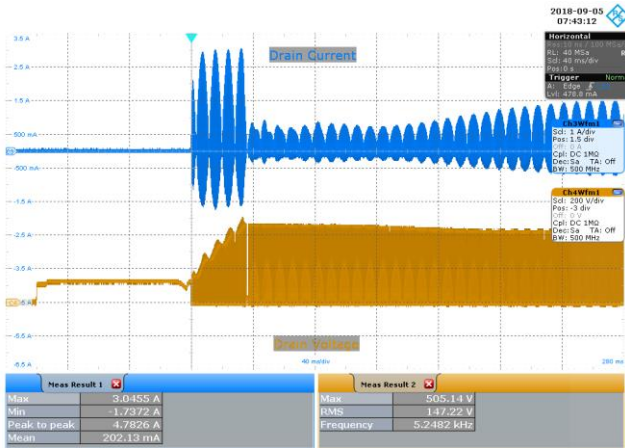

Figure 61 – 90 VAC 60 Hz, Full Load Start-up.
Upper: I_{DRAIN} , 1 A / div.
Lower: V_{DRAIN} , 200 V / div., 40 ms / div.

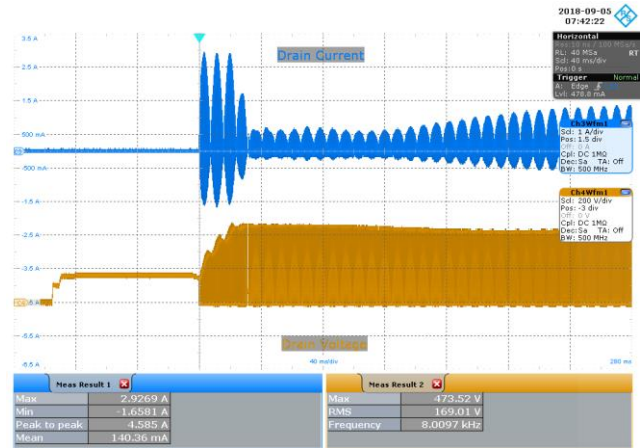

Figure 62 – 115 VAC 60 Hz, Full Load Start-up.
Upper: I_{DRAIN} , 1 A / div.
Lower: V_{DRAIN} , 200 V / div., 40 ms / div.

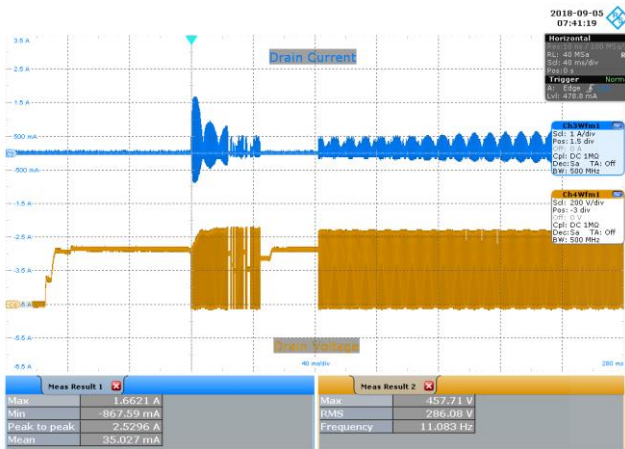

Figure 63 – 230 VAC 50 Hz, Full Load Start-up.
Upper: I_{DRAIN} , 1 A / div.
Lower: V_{DRAIN} , 200 V / div., 40 ms / div.

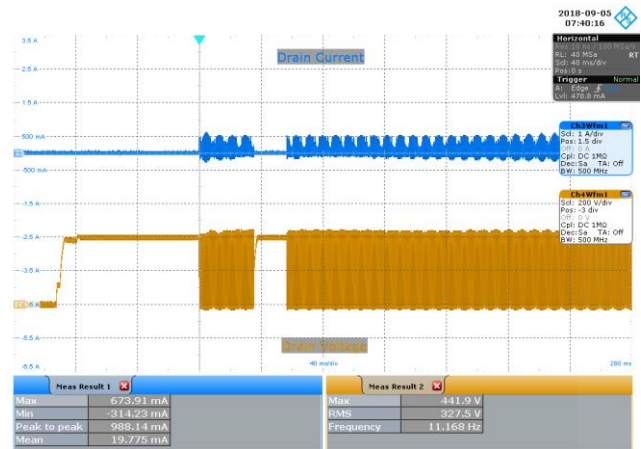

Figure 64 – 277 VAC 60 Hz, Full Load Start-up.
Upper: I_{DRAIN} , 1 A / div.
Lower: V_{DRAIN} , 200 V / div., 40 ms / div.

13.6 LYTSwitch-6 Drain Voltage and Current Waveforms at Normal Operation

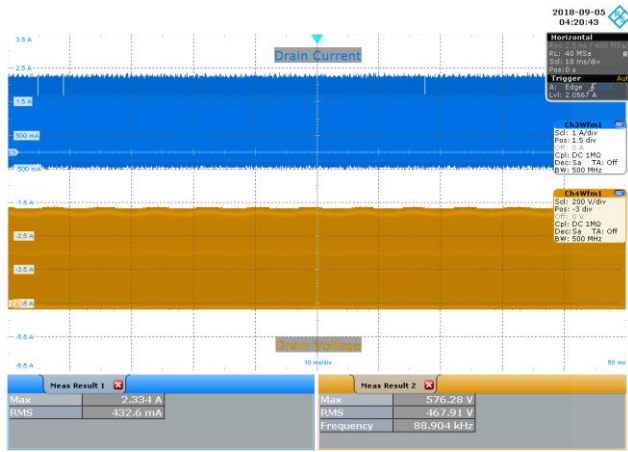

Figure 65 – 90 VAC 60 Hz, Full Load Normal.
Upper: I_{DRAIN} , 1 A / div.
Lower: V_{DRAIN} , 200 V / div., 10 ms / div.

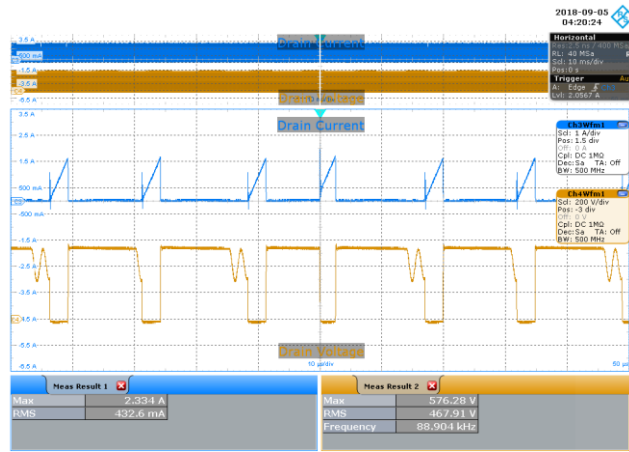

Figure 66 – 90 VAC 60 Hz, Full Load Normal.
Upper: I_{DRAIN} , 1 A / div.
Lower: V_{DRAIN} , 200 V / div., 10 μ s / div.

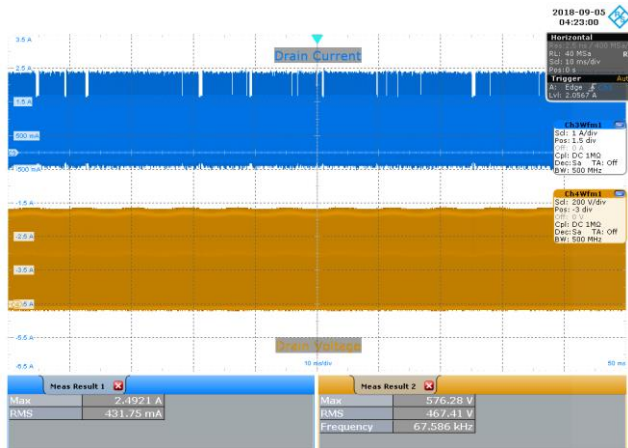

Figure 67 – 115 VAC 60 Hz, Full Load Normal.
Upper: I_{DRAIN} , 1 A / div.
Lower: V_{DRAIN} , 200 V / div., 10 ms / div.

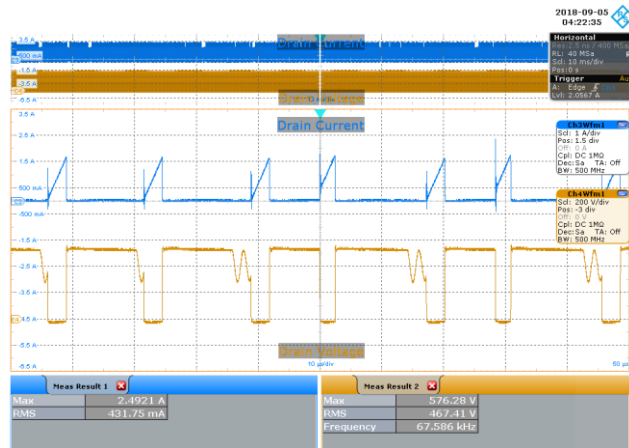

Figure 68 – 115 VAC 60 Hz, Full Load Normal.
Upper: I_{DRAIN} , 1 A / div.
Lower: V_{DRAIN} , 200 V / div., 10 μ s / div.

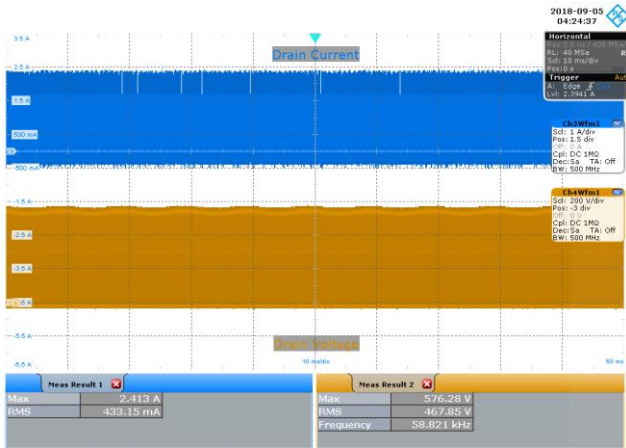

Figure 69 – 230 VAC 50 Hz, Full Load Normal.
 Upper: I_{DRAIN} , 1 A / div.
 Lower: V_{DRAIN} , 200 V / div., 10 ms / div.

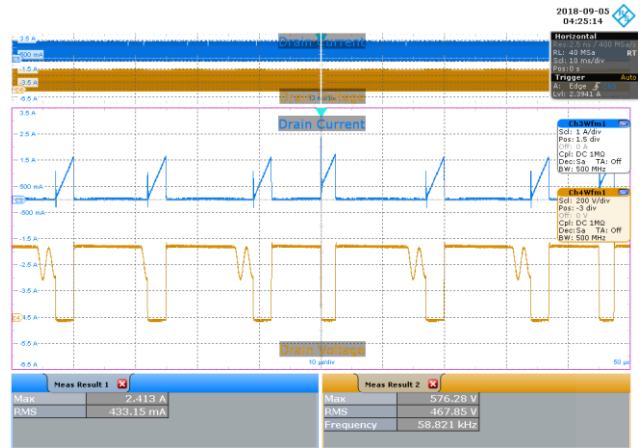

Figure 70 – 230 VAC 50 Hz, Full Load Normal.
 Upper: I_{DRAIN} , 1 A / div.
 Lower: V_{DRAIN} , 200 V / div., 10 μ s / div.

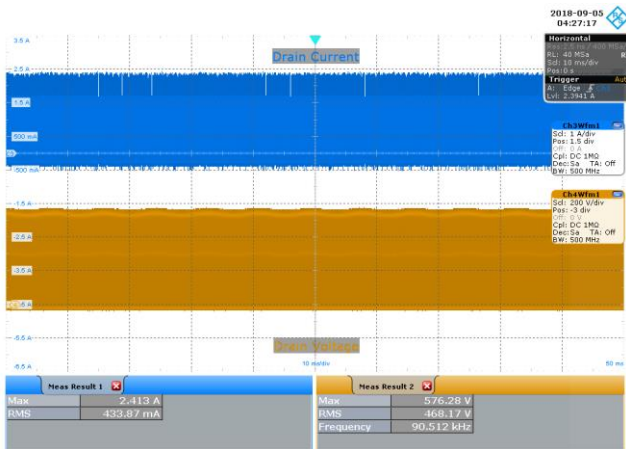

Figure 71 – 277 VAC 60 Hz, Full Load Normal.
 Upper: I_{DRAIN} , 1 A / div.
 Lower: V_{DRAIN} , 200 V / div., 10 ms / div.

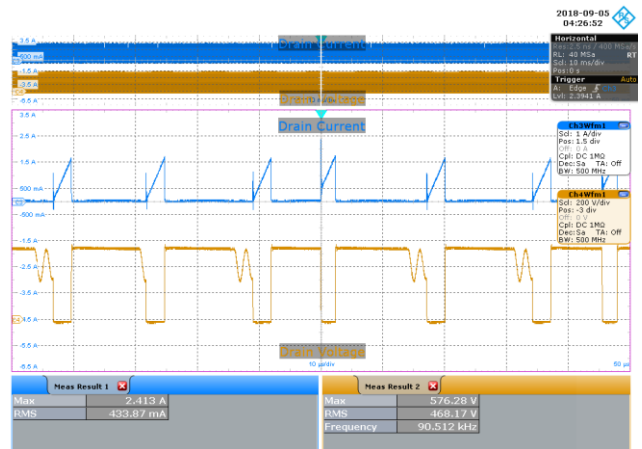

Figure 72 – 277 VAC 60 Hz, Full Load Normal.
 Upper: I_{DRAIN} , 1 A / div.
 Lower: V_{DRAIN} , 200 V / div., 10 μ s / div.

13.7 LYTSwitch-6 Drain Voltage and Current at Full Load Start-up

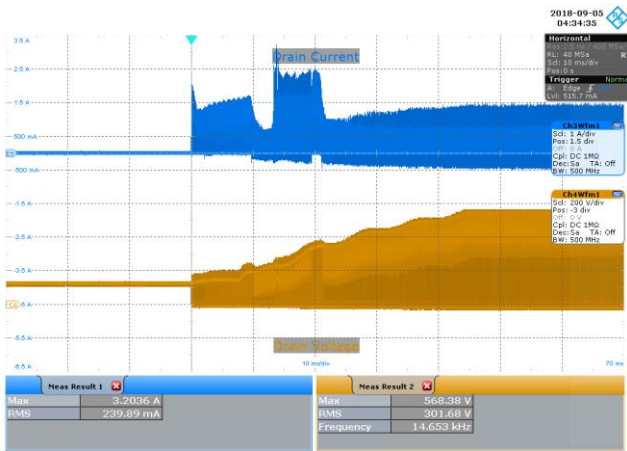

Figure 73 – 90 VAC 60 Hz, Full Load Start-up.
Upper: I_{DRAIN} , 1 A / div.
Lower: V_{DRAIN} , 200 V / div., 10 ms / div.

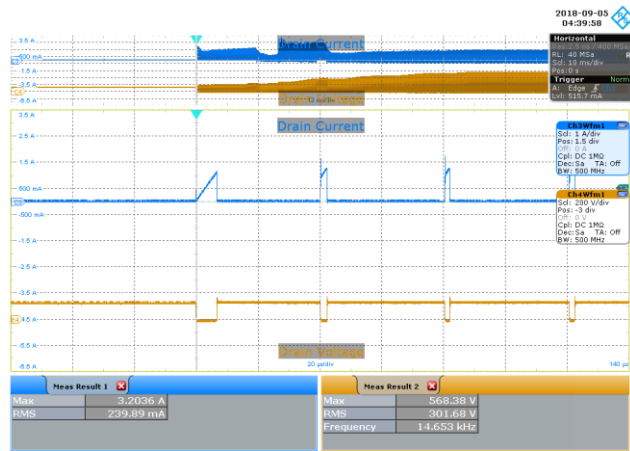

Figure 74 – 90 VAC 60 Hz, Full Load Start-up.
Upper: I_{DRAIN} , 1 A / div.
Lower: V_{DRAIN} , 200 V / div., 20 μ s / div.

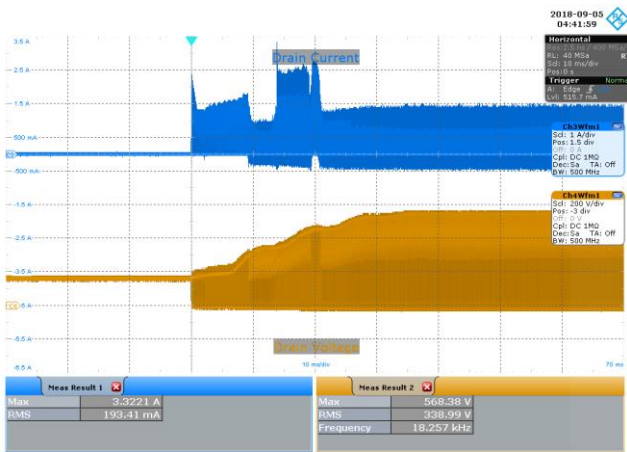

Figure 75 – 115 VAC 60 Hz, Full Load Start-up.
Upper: I_{DRAIN} , 1 A / div.
Lower: V_{DRAIN} , 200 V / div., 10 ms / div.

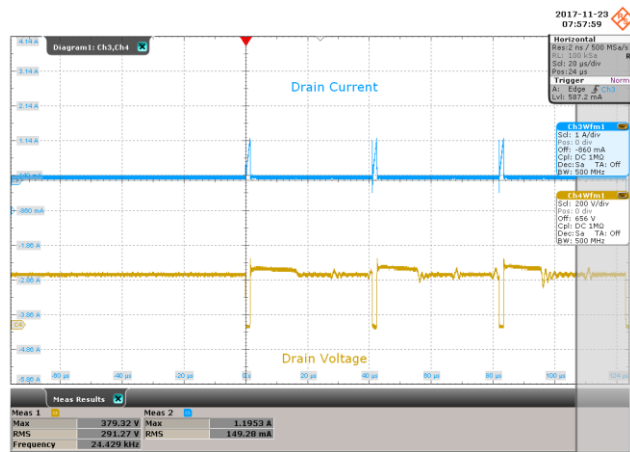

Figure 76 – 115 VAC 60 Hz, Full Load Start-up.
Upper: I_{DRAIN} , 1 A / div.
Lower: V_{DRAIN} , 200 V / div., 20 μ s / div.

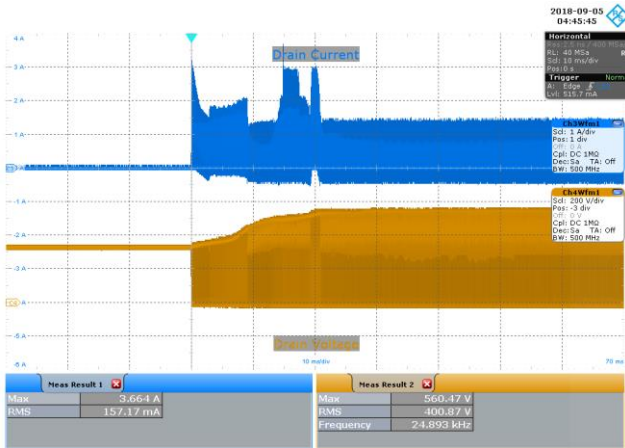

Figure 77 – 230 VAC 50 Hz, Full Load Start-up.
Upper: I_{DRAIN} , 1 A / div.
Lower: V_{DRAIN} , 200 V / div., 10 ms / div.

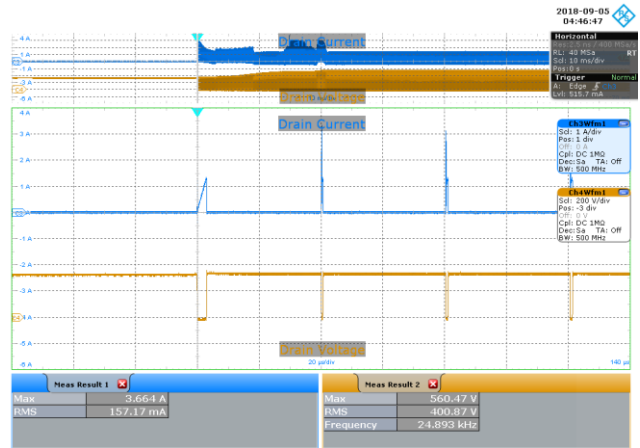

Figure 78 – 230 VAC 50 Hz, Full Load Start-up.
Upper: I_{DRAIN} , 1 A / div.
Lower: V_{DRAIN} , 200 V / div., 20 μ s / div.

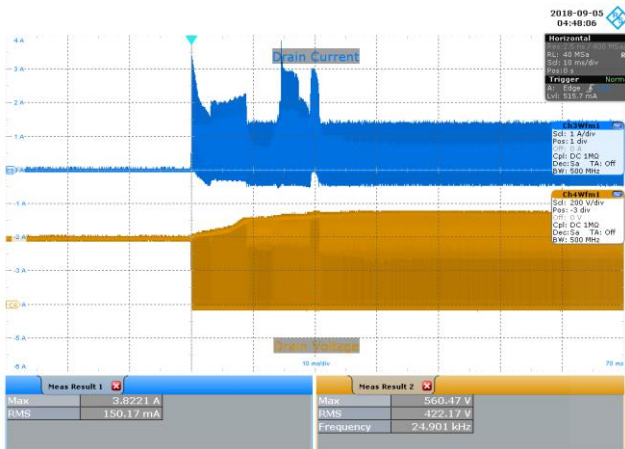

Figure 79 – 277 VAC 60 Hz, Full Load Start-up.
Upper: I_{DRAIN} , 1 A / div.
Lower: V_{DRAIN} , 200 V / div., 10 ms / div.

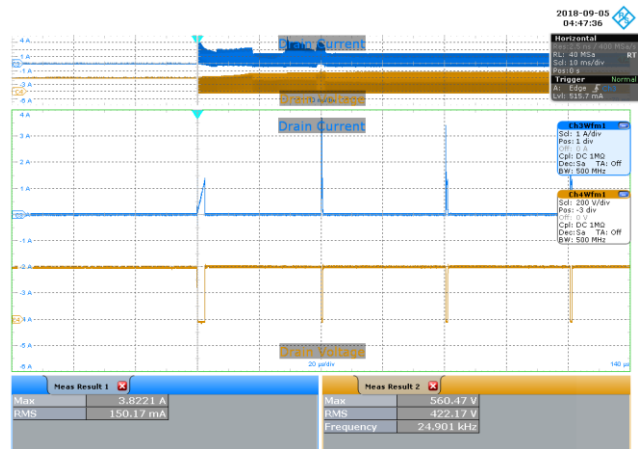

Figure 80 – 277 VAC 60 Hz, Full Load Start-up.
Upper: I_{DRAIN} , 1 A / div.
Lower: V_{DRAIN} , 200 V / div., 20 μ s / div.

13.8 LYTSwitch-6 Drain Voltage and Current during Output Short-Circuit

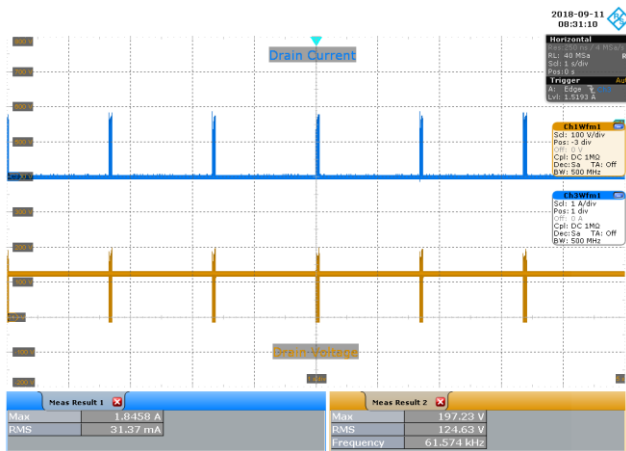

Figure 81 – 90 VAC 60 Hz, Output Shorted.
 Upper: I_{DRAIN} , 1 A / div.
 Lower: V_{DRAIN} , 100 V / div., 1 s / div.
 P_{IN} Average: 34 mW.

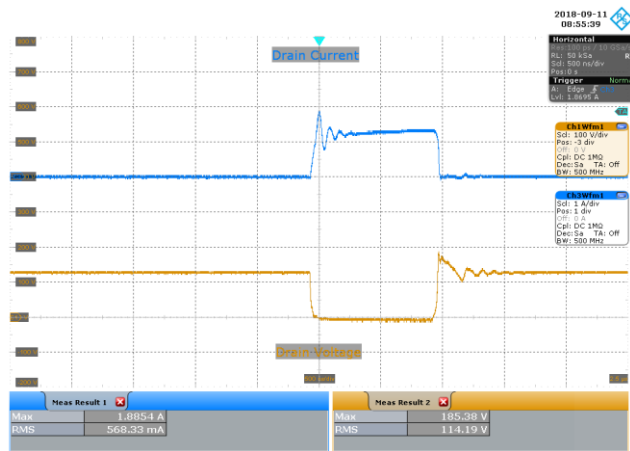

Figure 82 – 90 VAC 60 Hz, Output Shorted.
 Upper: I_{DRAIN} , 1 A / div.
 Lower: V_{DRAIN} , 100 V / div., 500 ns / div.

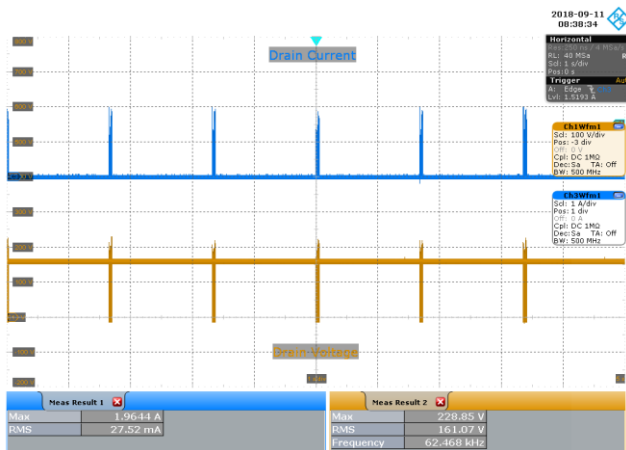

Figure 83 – 115 VAC 60 Hz, Output Shorted.
 Upper: I_{DRAIN} , 1 A / div.
 Lower: V_{DRAIN} , 100 V / div., 1 s / div.
 P_{IN} Average: 47 mW.

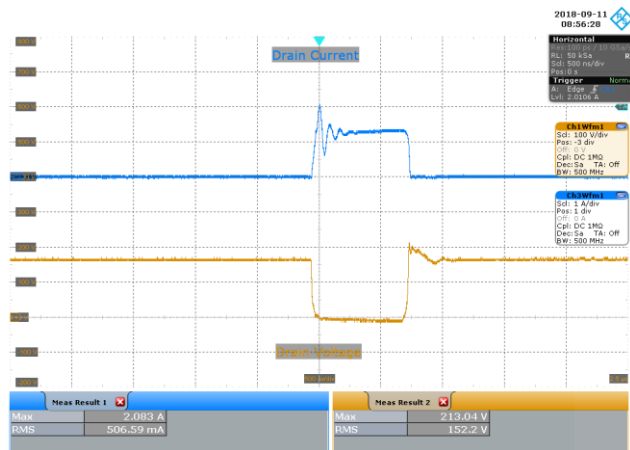

Figure 84 – 115 VAC 60 Hz, Output Shorted.
 Upper: I_{DRAIN} , 1 A / div.
 Lower: V_{DRAIN} , 100 V / div., 500 ns / div.

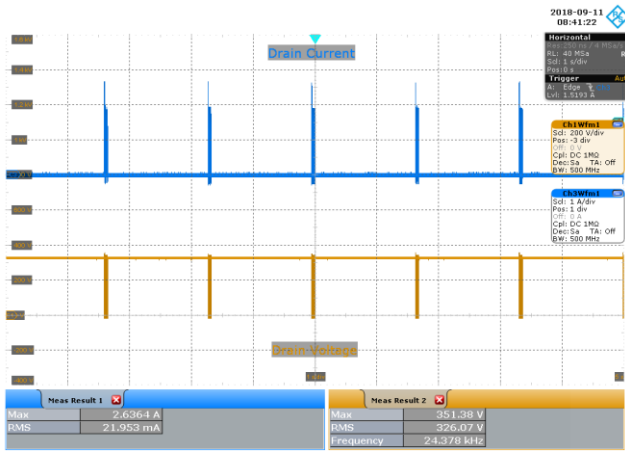

Figure 85 – 230 VAC 50 Hz, Output Shorted.
 Upper: I_{DRAIN} , 1 A / div.
 Lower: V_{DRAIN} , 200 V / div., 1 s / div.
 P_{IN} Average: 120 mW.

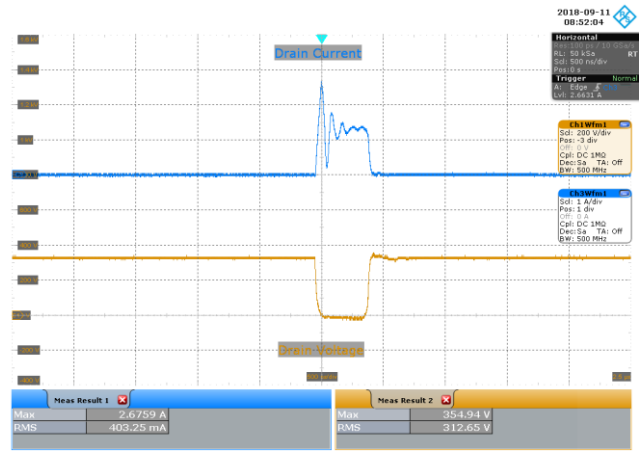

Figure 86 – 230 VAC 50 Hz, Output Shorted.
 Upper: I_{DRAIN} , 1 A / div.
 Lower: V_{DRAIN} , 200 V / div., 500 ns / div.

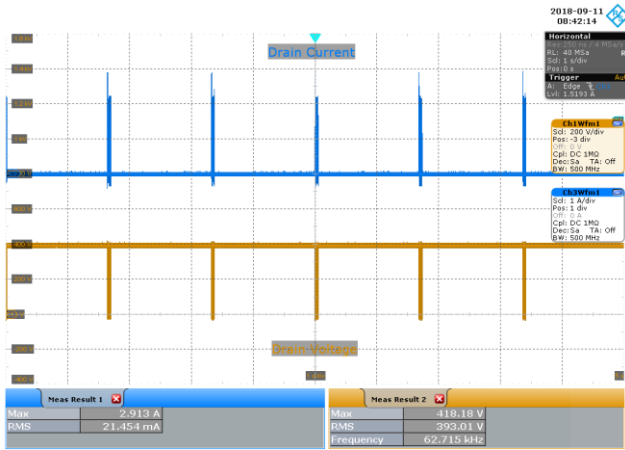

Figure 87 – 277 VAC 60 Hz, Output Shorted
 Upper: I_{DRAIN} , 1 A / div.
 Lower: V_{DRAIN} , 200 V / div., 1 s / div.
 P_{IN} Average: 254 mW.

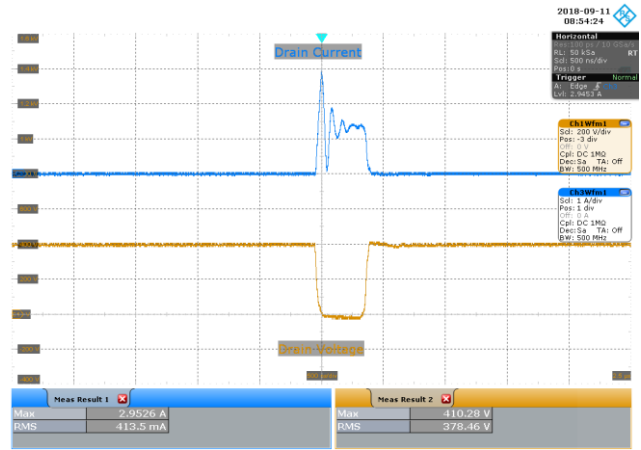

Figure 88 – 277 VAC 60 Hz, Output Shorted.
 Upper: I_{DRAIN} , 1 A / div.
 Lower: V_{DRAIN} , 200 V / div., 500 ns / div.



13.8.1 Input Power during Output Short Circuit

Integration Time: 3 minutes.

Input				
VAC (V _{RMS})	Freq (Hz)	V _{IN} (V _{RMS})	I _{IN} (mA _{RMS})	P _{IN} (mW)
90	60	90.0	16.2	34.2
100	60	100	17.5	39.0
110	60	110	18.9	44.2
115	60	115	19.6	46.8
120	60	120	20.2	49.3
132	60	132	21.8	56.1
180	50	180	24.4	84.6
200	50	200	26.3	97.8
220	50	220	28.2	113
230	50	230	29.3	120
240	50	240	30.3	224
265	50	265	32.8	241
277	60	277	39.8	254

13.9 Brown-In and Brown-Out at 2 V / Minute Rate

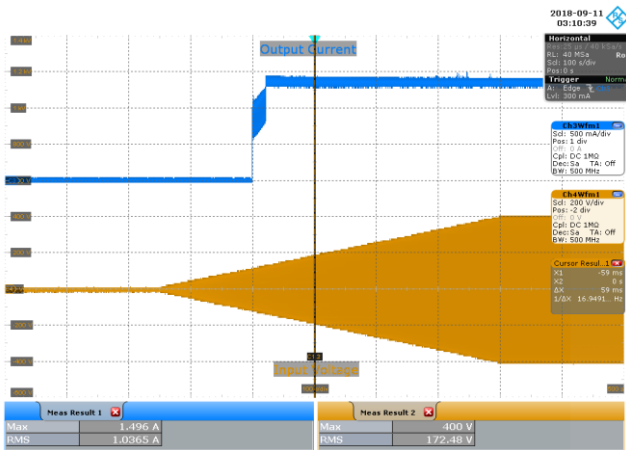

Figure 89 – 0 to 277 VAC 60 Hz, 1350 mA LED Load.
 Upper: 500 mA / div.
 Lower: 200 V / div.
 Horizontal: 100 s / div.

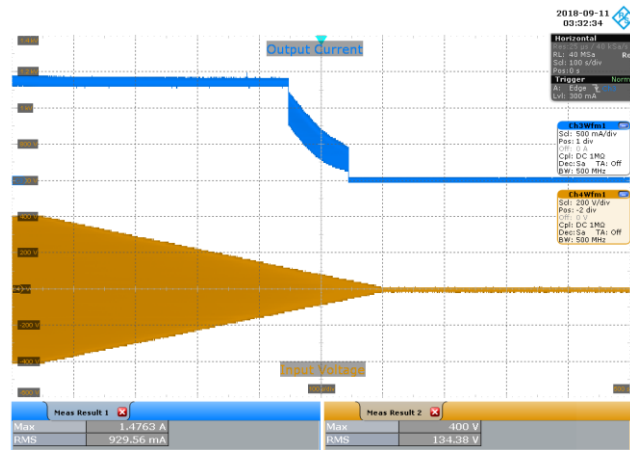

Figure 90 – 277 to 0 VAC 60 Hz, 1350 mA LED Load.
 Upper: 500 mA / div.
 Lower: 200 V / div.
 Horizontal: 100 s / div.

13.10 AC Cycling Test at 48 V LED Load

No output current overshoot or undershoot was observed during on/off cycling.

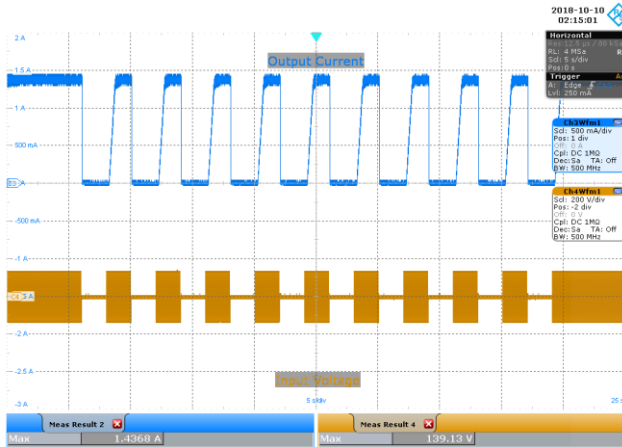

Figure 91 – 90 VAC 60 Hz, 48 V LED Load.
 2 s On – 2 s Off.
 Upper: 500 mA / div.
 Lower: 200 V / div., 5 s / div.
 I_{OUT} Maximum: 1.44 A.

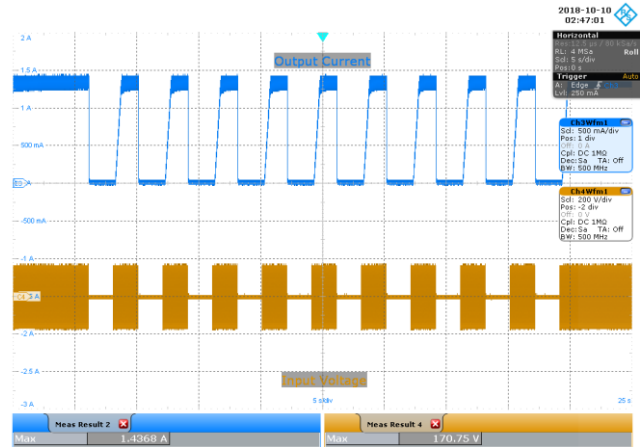

Figure 92 – 115 VAC 60 Hz, 48 V LED Load.
 2 s On – 2 s Off.
 Upper: 500 mA / div.
 Lower: 200 V / div., 5 s / div.
 I_{OUT} Maximum: 1.44 A.

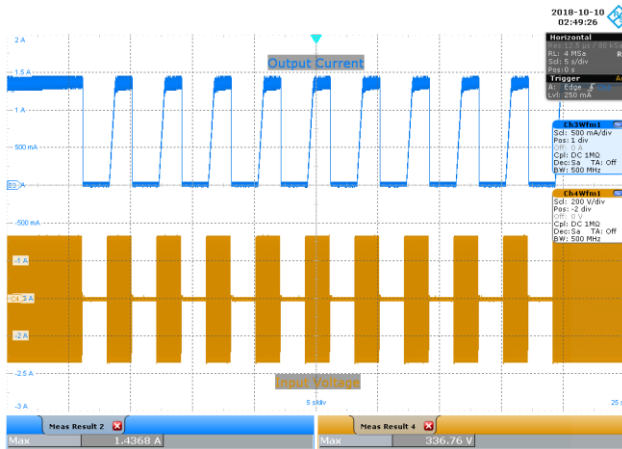

Figure 93 – 230 VAC 50 Hz, 48 V LED Load.
 2 s On – 2 s Off.
 Upper: 500 mA / div.
 Lower: 200 V / div., 5 s / div.
 I_{OUT} Maximum: 1.44 A.

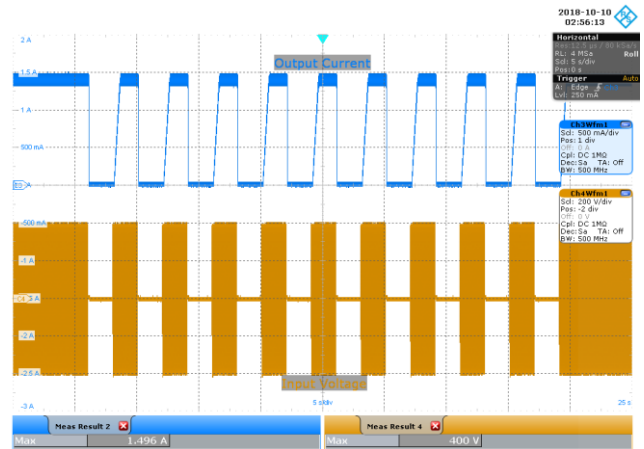

Figure 94 – 277 VAC 60 Hz, 48 V LED Load.
 2 s On – 2 s Off.
 Upper: 500 mA / div.
 Lower: 200 V / div., 5 s / div.
 I_{OUT} Maximum: 1.50 A.



13.11 AC Cycling Test at 36 V LED Load

No output current overshoot or undershoot was observed during on/off cycling.

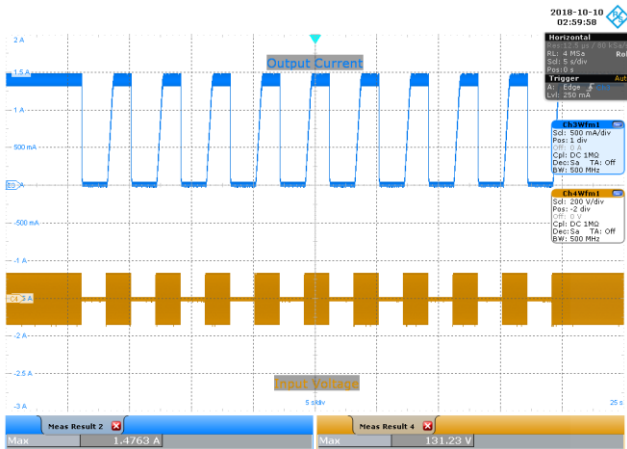

Figure 95 – 90 VAC 60 Hz, 36 V LED Load.
 2 s On – 2 s Off.
 Upper: 500 mA / div.
 Lower: 200 V / div., 5 s / div.
 I_{OUT} Maximum: 1.48 A.

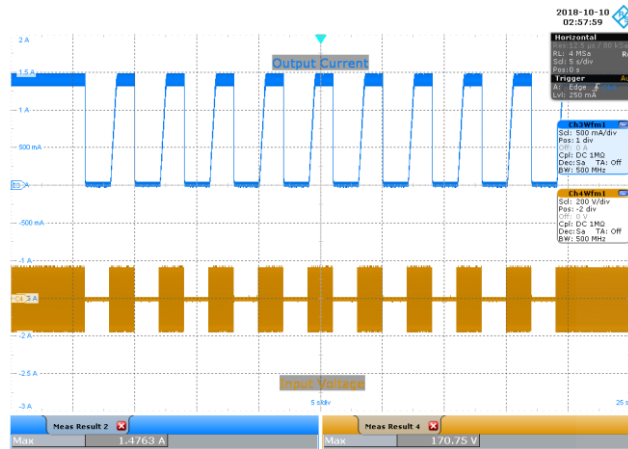

Figure 96 – 115 VAC 60 Hz, 36 V LED Load.
 2 s On – 2 s Off.
 Upper: 500 mA / div.
 Lower: 200 V / div., 5 s / div.
 I_{OUT} Maximum: 1.48 A.

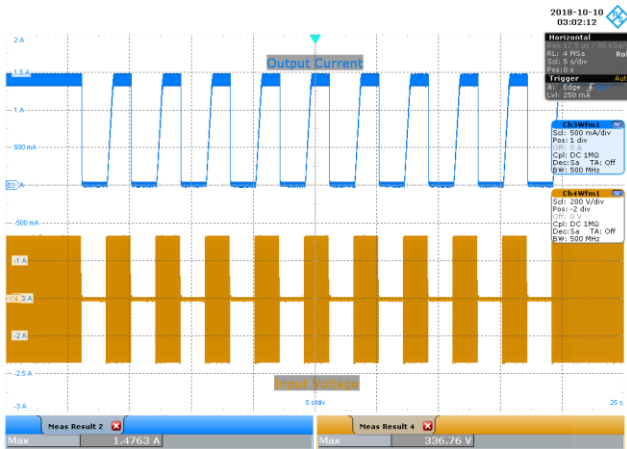

Figure 97 – 230 VAC 50 Hz, 36 V LED Load.
 2 s On – 2 s Off.
 Upper: 500 mA / div.
 Lower: 200 V / div., 5 s / div.
 I_{OUT} Maximum: 1.48 A.

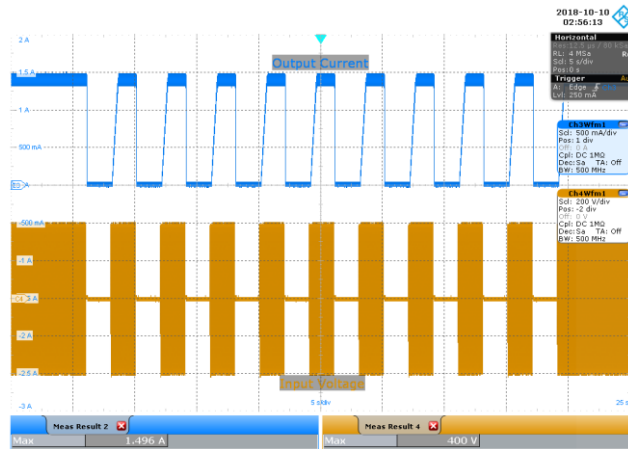

Figure 98 – 277 VAC 60 Hz, 36 V LED Load.
 2 s On – 2 s Off.
 Upper: 500 mA / div.
 Lower: 200 V / div., 5 s / div.
 I_{OUT} Maximum: 1.50 A.

13.12 Output Current Ripple

13.12.1 Equipment Used

1. Rohde & Schwarz RTO1004 Oscilloscope
2. Rohde & Schwarz RT-ZC20B Current Probe
3. 48V LED Load

13.12.2 Ripple Ratio and Flicker % Measurement

V_{IN} (VAC)	$I_{OUT(MAX)}$ (mA)	$I_{OUT(MIN)}$ (mA)	I_{MEAN} (mA)	Ripple Ratio (I_{RP-P}/I_{MEAN})	% Flicker $100 \times (I_{RP-P} / I_{OUT(MAX)+I_{OUT(MIN)}})$
90	1373.0	1305.8	1341.0	0.05	2.51
115	1388.8	1317.7	1356.4	0.05	2.63
230	1392.8	1317.7	1356.7	0.06	2.77
277	1392.8	1317.7	1356.8	0.06	2.77

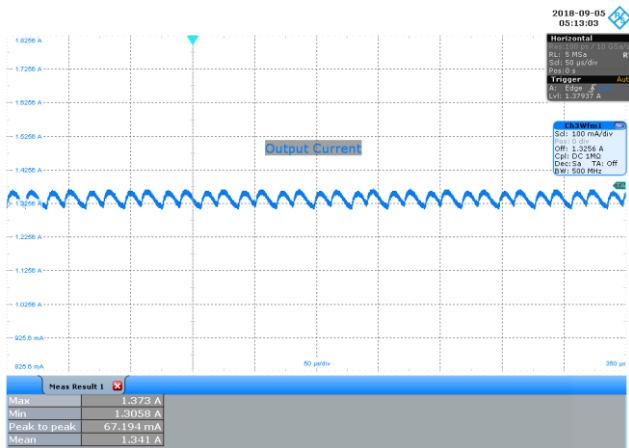

Figure 99 – 90 VAC 60 Hz, 1350 mA LED Load.
 20 MHz Bandwidth.
 I_{OUT} , 100 mA / div., 50 μ s / div.
 Ripple Current: 67.194 mA_{PK-PK}.

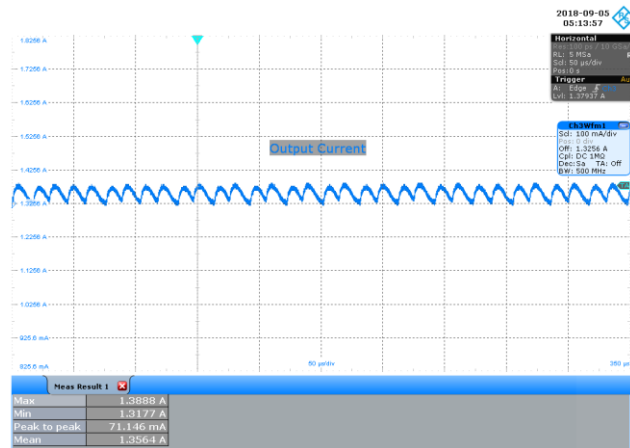

Figure 100 – 115 VAC 60 Hz, 1350 mA LED Load.
 20 MHz Bandwidth.
 I_{OUT} , 100 mA / div., 50 μ s / div.
 Ripple Current: 71.146 mA_{PK-PK}.

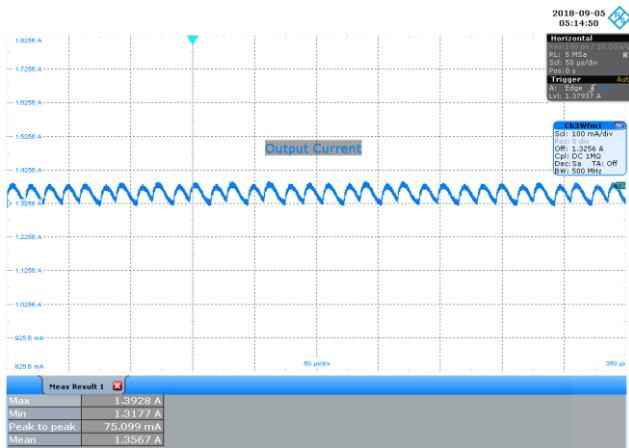

Figure 101 – 230 VAC 50 Hz, 1350 mA LED Load.
 20 MHz Bandwidth.
 I_{OUT} , 100 mA / div., 50 μ s / div.
 Ripple Current: 75.099 mA_{PK-PK}.

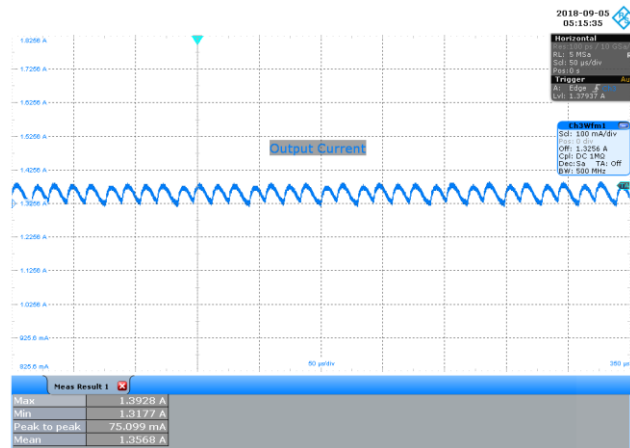

Figure 102 – 277 VAC 50 Hz, 1350 mA LED Load.
 20 MHz Bandwidth.
 I_{OUT} , 100 mA / div., 50 μ s / div.
 Ripple Voltage: 75.099 mA_{PK-PK}.

14 Conducted EMI

14.1 Test Set-up

14.1.1 Equipment and Load Used

1. Rohde and Schwarz ENV216 two line V-network
2. Rohde and Schwarz ESRP EMI test receiver
3. Hioki 3332 power hitester
4. Chroma Measurement Test Fixture model A662003
5. 48V LED Load
6. HOSSONI TDGC2 VARIAC set at 115 VAC and 230 VAC, 60 Hz

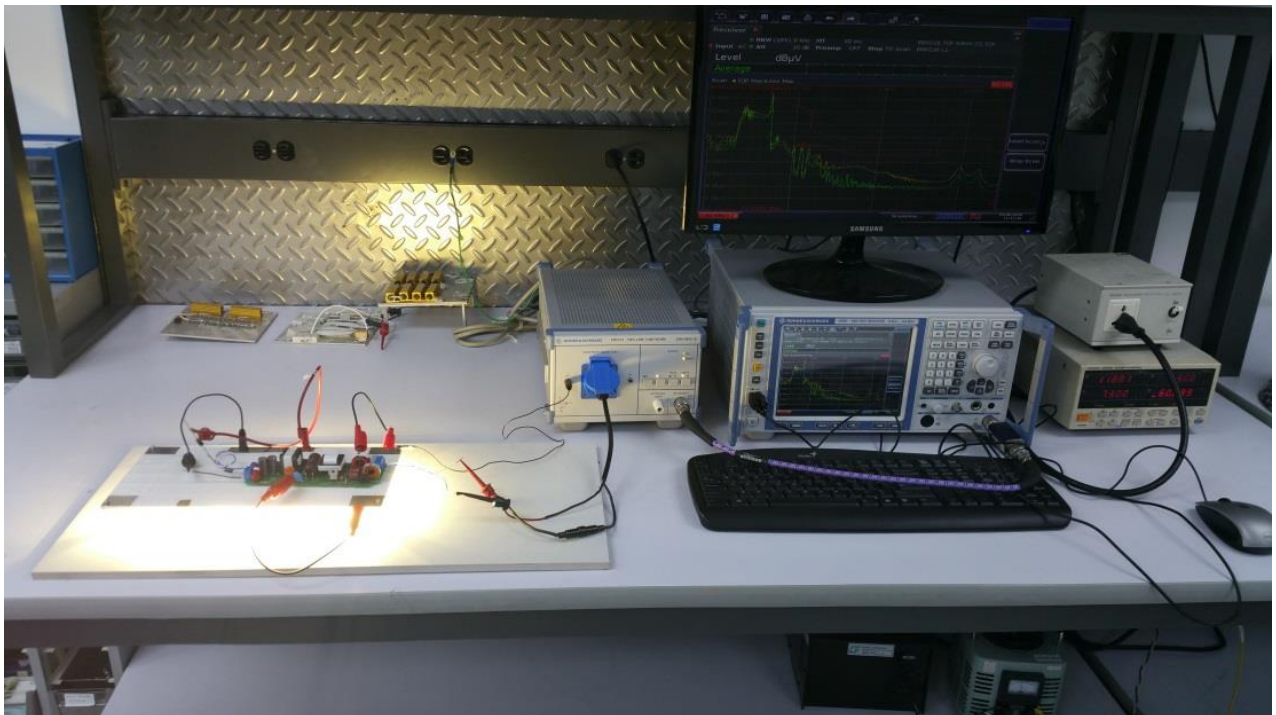
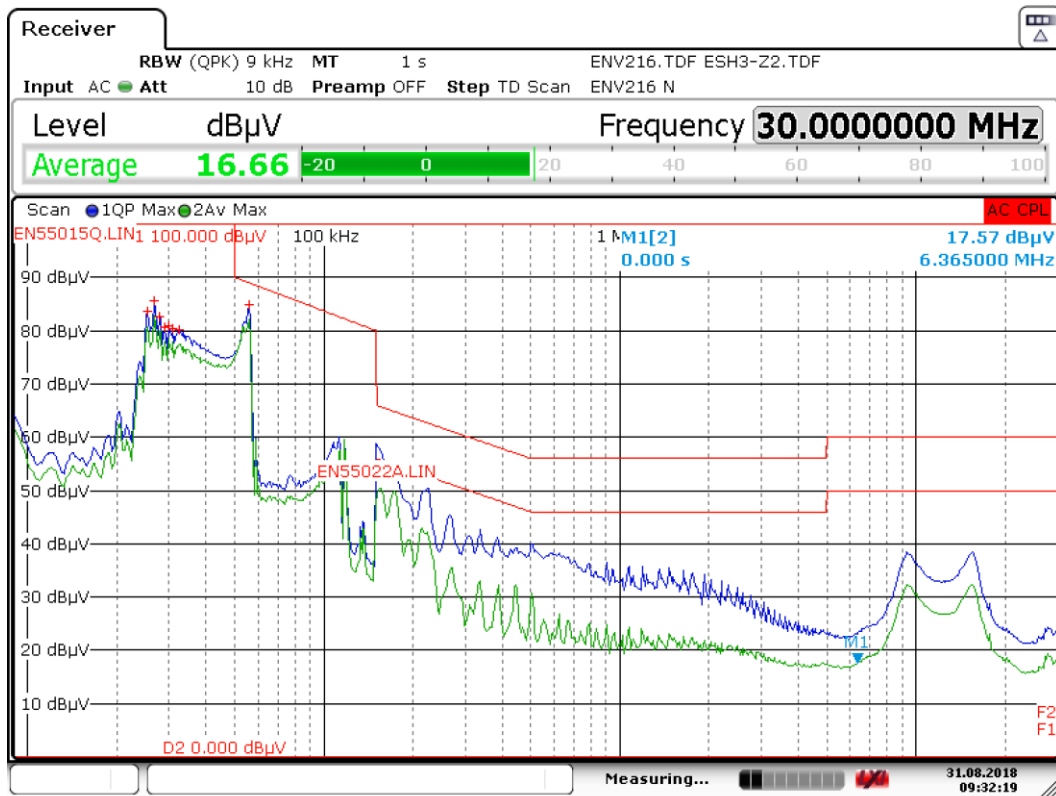

Figure 103 — Conducted EMI Test Set-up.

14.2 EMI Test Result



Date: 31.AUG.2018 09:32:19

Figure 104 – Conducted EMI QP Scan at Full Load, Earthed, 115 VAC 60 Hz and EN55015 B Limits.

Trace1: EN55015Q.LIN		Trace2: EN55022A.LIN	
Trace/Detector	Frequency	Level dBµV	DeltaLimit
1 Quasi Peak	56.2500 kHz	84.84 L1	-4.09 dB
1 Quasi Peak	26.8000 kHz	85.66 L1	-24.34 dB
1 Quasi Peak	25.4000 kHz	83.60 L1	-26.40 dB
1 Quasi Peak	27.9500 kHz	82.58 L1	-27.42 dB
1 Quasi Peak	29.9500 kHz	81.00 L1	-29.00 dB
1 Quasi Peak	28.9500 kHz	80.73 L1	-29.27 dB
1 Quasi Peak	30.9000 kHz	80.48 L1	-29.52 dB
1 Quasi Peak	32.6500 kHz	80.15 L1	-29.85 dB

Figure 105 – Conducted EMI Data at 115 VAC 60 Hz, Full Load Earthed.

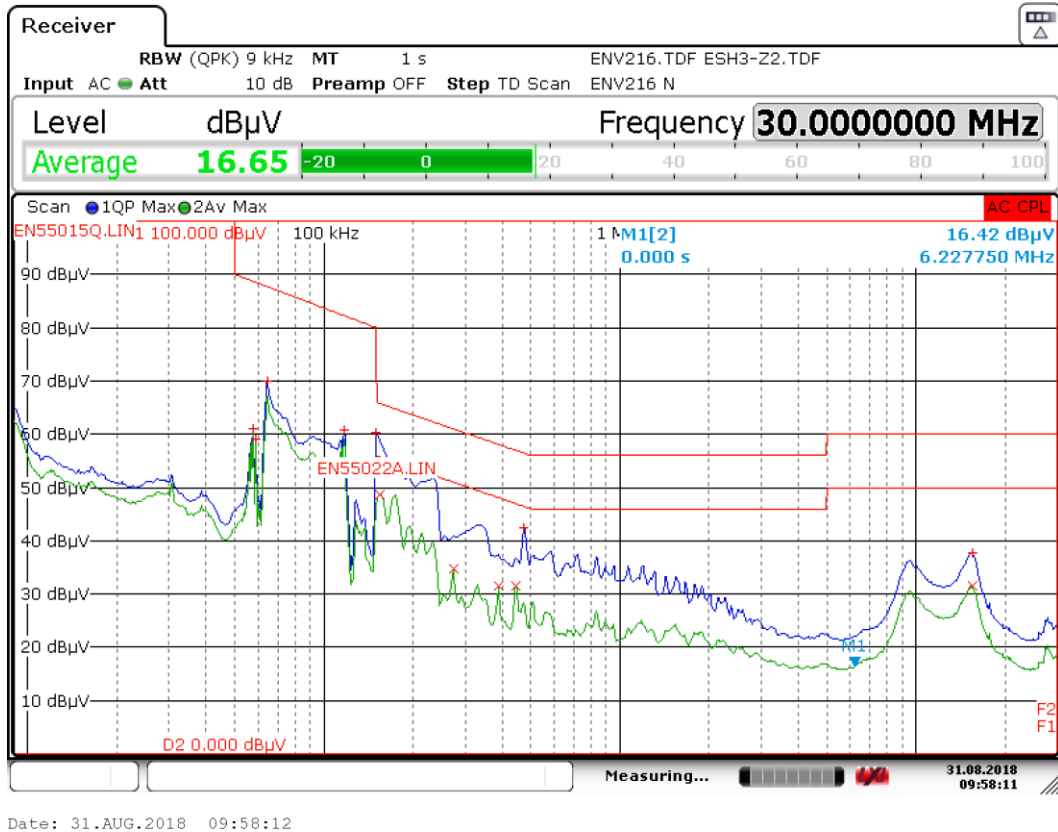

Figure 106 – Conducted EMI QP Scan at Full Load, Earthed, 230 VAC 60 Hz and EN55015 B Limits.

Trace1: EN55015Q.LIN		Trace2: EN55022A.LIN	
Trace/Detector	Frequency	Level dBµV	DeltaLimit
1 Quasi Peak	150.0000 kHz	60.35 L1	-5.65 dB
2 Average	154.5000 kHz	48.70 L1	-7.05 dB
1 Quasi Peak	474.0000 kHz	42.37 L1	-14.07 dB
2 Average	447.0000 kHz	31.54 N	-15.39 dB
2 Average	273.7500 kHz	34.83 N	-16.17 dB
2 Average	388.5000 kHz	31.53 N	-16.57 dB
1 Quasi Peak	64.7500 kHz	70.02 L1	-17.63 dB
2 Average	15.5090 MHz	31.53 L1	-18.47 dB
1 Quasi Peak	117.0000 kHz	60.86 L1	-21.40 dB
1 Quasi Peak	15.5113 MHz	37.77 L1	-22.23 dB
1 Quasi Peak	57.8500 kHz	61.16 L1	-27.51 dB
1 Quasi Peak	59.1500 kHz	59.13 L1	-29.34 dB

Figure 107 – Conducted EMI Data at 230 VAC 60 Hz, Full Load Earthed.

15 Line Surge

The unit was subjected to ± 2500 V ring wave and ± 1000 V differential surge with 10 strikes for each condition. The test is considered a failure in case of non-recoverable interruption of output that requires either repair or AC recycling.

15.1 Differential Surge Test Results

Surge Level (V)	Input Voltage (VAC)	Injection Location	Injection Phase (°)	Line Impedance (Ω)	Test Result (Pass/Fail)
+1000	115	L to N	0	2	Pass
+1000	115	L to N	90	2	Pass
+1000	115	L to N	270	2	Pass
-1000	115	L to N	0	2	Pass
-1000	115	L to N	90	2	Pass
-1000	115	L to N	270	2	Pass
+1000	230	L to N	0	2	Pass
+1000	230	L to N	90	2	Pass
+1000	230	L to N	270	2	Pass
-1000	230	L to N	0	2	Pass
-1000	230	L to N	90	2	Pass
-1000	230	L to N	270	2	Pass

15.2 Ring Wave Surge Test Results

Surge Level (V)	Input Voltage (VAC)	Injection Location	Injection Phase (°)	Line Impedance (Ω)	Test Result (Pass/Fail)
+2500	115	L to N	0	12	Pass
+2500	115	L to N	90	12	Pass
+2500	115	L to N	270	12	Pass
-2500	115	L to N	0	12	Pass
-2500	115	L to N	90	12	Pass
-2500	115	L to N	270	12	Pass
+2500	230	L to N	0	12	Pass
+2500	230	L to N	90	12	Pass
+2500	230	L to N	270	12	Pass
-2500	230	L to N	0	12	Pass
-2500	230	L to N	90	12	Pass
-2500	230	L to N	270	12	Pass

16 Revision History

Date	Author	Revision	Description and Changes	Reviewed
03-Dec-18	JB	1.0	Initial Release.	Apps & Mktg



For the latest updates, visit our website: www.power.com

Reference Designs are technical proposals concerning how to use Power Integrations' gate drivers in particular applications and/or with certain power modules. These proposals are "as is" and are not subject to any qualification process. The suitability, implementation and qualification are the sole responsibility of the end user. The statements, technical information and recommendations contained herein are believed to be accurate as of the date hereof. All parameters, numbers, values and other technical data included in the technical information were calculated and determined to our best knowledge in accordance with the relevant technical norms (if any). They may base on assumptions or operational conditions that do not necessarily apply in general. We exclude any representation or warranty, express or implied, in relation to the accuracy or completeness of the statements, technical information and recommendations contained herein. No responsibility is accepted for the accuracy or sufficiency of any of the statements, technical information, recommendations or opinions communicated and any liability for any direct, indirect or consequential loss or damage suffered by any person arising therefrom is expressly disclaimed.

Power Integrations reserves the right to make changes to its products at any time to improve reliability or manufacturability. Power Integrations does not assume any liability arising from the use of any device or circuit described herein. POWER INTEGRATIONS MAKES NO WARRANTY HEREIN AND SPECIFICALLY DISCLAIMS ALL WARRANTIES INCLUDING, WITHOUT LIMITATION, THE IMPLIED WARRANTIES OF MERCHANTABILITY, FITNESS FOR A PARTICULAR PURPOSE, AND NON-INFRINGEMENT OF THIRD PARTY RIGHTS.

Patent Information

The products and applications illustrated herein (including transformer construction and circuits' external to the products) may be covered by one or more U.S. and foreign patents, or potentially by pending U.S. and foreign patent applications assigned to Power Integrations. A complete list of Power Integrations' patents may be found at www.power.com. Power Integrations grants its customers a license under certain patent rights as set forth at <http://www.power.com/ip.htm>.

The PI Logo, TOPSwitch, TinySwitch, LinkSwitch, LYTSwitch, InnoSwitch, DPA-Switch, PeakSwitch, CAPZero, SENZero, LinkZero, HiperPFS, HiperTFS, HiperLCS, Qspeed, EcoSmart, Clampless, E-Shield, Filterfuse, FluxLink, StackFET, PI Expert and PI FACTS are trademarks of Power Integrations, Inc. Other trademarks are property of their respective companies. ©Copyright 2015 Power Integrations, Inc.

Power Integrations Worldwide Sales Support Locations**WORLD HEADQUARTERS**

5245 Hellyer Avenue
San Jose, CA 95138, USA.
Main: +1-408-414-9200
Customer Service:
Phone: +1-408-414-9665
Fax: +1-408-414-9765
e-mail: usasales@power.com

GERMANY

(IGBT Driver Sales)
HellwegForum 1
59469 Ense, Germany
Tel: +49-2938-64-39990
Email: igbt-driver.sales@power.com

KOREA

RM 602, 6FL
Korea City Air Terminal B/D,
159-6
Samsung-Dong, Kangnam-Gu,
Seoul, 135-728 Korea
Phone: +82-2-2016-6610
Fax: +82-2-2016-6630
e-mail: koreasales@power.com

CHINA (SHANGHAI)

Rm 2410, Charity Plaza, No.
88,
North Caoxi Road,
Shanghai, PRC 200030
Phone: +86-21-6354-6323
Fax: +86-21-6354-6325
e-mail:
chinasales@power.com

INDIA

#1, 14th Main Road
Vasanthanagar
Bangalore-560052
India
Phone: +91-80-4113-8020
Fax: +91-80-4113-8023
e-mail:
indiasales@power.com

SINGAPORE

51 Newton Road,
#19-01/05 Goldhill Plaza
Singapore, 308900
Phone: +65-6358-2160
Fax: +65-6358-2015
e-mail:
singaporesales@power.com

CHINA (SHENZHEN)

17/F, Hivac Building, No. 2, Keji
Nan 8th Road, Nanshan District,
Shenzhen, China, 518057
Phone: +86-755-8672-8689
Fax: +86-755-8672-8690
e-mail: chinasales@power.com

ITALY

Via Milanese 20, 3rd. Fl.
20099 Sesto San Giovanni (MI)
Italy
Phone: +39-024-550-8701
Fax: +39-028-928-6009
e-mail: eurosales@power.com

TAIWAN

5F, No. 318, Nei Hu Rd.,
Sec. 1
Nei Hu District
Taipei 11493, Taiwan R.O.C.
Phone: +886-2-2659-4570
Fax: +886-2-2659-4550
e-mail: taiwansales@power.com

GERMANY

(AC-DC/LED Sales)
Lindwurmstrasse 114
80337, Munich
Germany
Phone: +49-895-527-39110
Fax: +49-895-527-39200
e-mail: eurosales@power.com

JAPAN

Kosei Dai-3 Building
2-12-11, Shin-Yokohama,
Kohoku-ku, Yokohama-shi,
Kanagawa 222-0033
Japan
Phone: +81-45-471-1021
Fax: +81-45-471-3717
e-mail: japansales@power.com

UK

Cambridge Semiconductor,
a Power Integrations company
Westbrook Centre, Block 5, 2nd
Floor
Milton Road
Cambridge CB4 1YG
Phone: +44 (0) 1223-446483
e-mail: eurosales@power.com

